

# CS2-VA VOLT / CURRENT Meter

## DESCRIPTION

CS2-VA Voltage/Current Indicator has been designed with high accuracy measurement, display and communication of 0~600V or 0~10A for DC/AC/TRMS.

Adtek builds flexible function as like as 3 bank (for multi-range scaling and set point) and 3 external control inputs meet to various testing equipment inquiry.

They are also build in 4 Relay outputs, 3 External Control Inputs, 1 Analogue output and 1 RS485 (Modbus RTU Mode) interface with versatile functions such as control, alarm, re-transmission and communication for a wide range of industrial applications.



## FEATURE

- Measuring Voltage 0~600V or Current 0~10A for DC / AC / TRMS
- Optional 4 banks pre-set for all relay functions are relative to 4 difference scaling, and selectable by 3 External Control Inputs(E.C.I.) or front key
- 4 relay can be programmed individual to be a Hi / Lo / Hi Latch / Lo Latch / Go energized with Start Delay / Hysteresis / Energized & De-energized Delay functions, or to be a remote control.
- Analogue output and RS 485 communication port in option
- 3 external control inputs can be programmed individual to be Relative PV (Tare) / PV Hold / Maximum or Minimum Hold / DI (remote monitoring) / Reset for Relay Energized Latch....
- CE Approved & RoHS

## APPLICATIONS

- Testing Equipments for Volt/Current Measuring, Alarm, Control and Communication with PC/PLC
  - Flexible 3 DI functions as like as Maximum/Minimum hold, PV hold and Relative PV.
  - 4 Relay functions as like as Hi / Lo / Go with on and off delay time from 0.0(s)~ 9(m):59.9(s)
  - 3 Banks preset for individual Hi / Lo scale, decimal point and 4 relay energized level and functions.
- MCC panel, Machinery, Switch gear... for Voltage or Current Measuring, Alarm and Remote I/O with PC/PLC
  - Fantastic 4 Relay functions as like as Hi / Lo / Hi latch / Lo latch / DO(Remote control by PC/PLC).
  - Flexible 3 DI functions as like as Reset for Relay energized and Remote monitoring by PC/PLC.

## ORDERING INFORMATION

CS2-VA- [DC/AC/TRMS Input Signal] - [Relay Output] - [Analog Output] - [RS 485 Port] - [Aux. Powered] \* [Optional Functions] Customize function is welcome. Please contact with our sales window for detail.

CODE	VOLT INPUT	CODE	CURRENT	CODE	RELAY O/P	CODE	ANALOG O/P	CODE	RS485 PORT	CODE	AXU. POWER
D	DC measuring	D	DC measuring	N	None	N	None	N	None	A	AC 115/230 V
A	AC measuring	A	AC measuring	R2	2 Relay	V	0(1) ~ 5 V	8	RS 485	OPTION 4	
T	TRMS measuring	T	TRMS measuring	R4	4 Relay	I	0 ~ 10mA 0(4)~20 mA			ADH	AC 85~264V DC 100~300V
V1	0 ~ 199.99 mV	A1	0 ~ 199.99 μA							ADL	DC 20~56V
V2	0 ~ 1.9999 V	A2	0 ~ 1.9999 mA								
V3	0 ~ 19.999 V	A3	0 ~ 19.999 mA								
V4	0 ~ 199.99 V	A4	0 ~ 199.99 mA								
V5	0 ~ 300.0 V	A5	0 ~ 1.9999 A								
V6	0 ~ 600 V	A6	0 ~ 1.0000 A								
VA	0 ~ 50 mV	A7	0 ~ 5.000 A								
VB	0 ~ 60 mV	A8	0 ~ 10.000 A								
VC	0 ~ 100 mV	AO	Specify A input								
VO	Specify V input										

CODE	OPTIONAL FUNCTION
3BK	3 Banks
HSM	High Speed Mode

## TECHNICAL SPECIFICATION

### Input

Measuring Range DC / AC / TRMS	Input Impedance	Measuring Range DC / AC / TRMS	Input Impedance
Voltage	0~50/~100 mV	0~199.99μA	1K ohm
	0~199.99 mV	0~1.9999 mA	100 ohm
	0~1.9999 V	0~19.999 mA	10 ohm
	0~19.999 V	0~199.99 mA	1 ohm
	0~199.99 V	0~1.9999 A	0.05 ohm
	0~300.0 V	0~5.000 A	0.02 ohm
0~600.0 V	≥2M ohm	0~10.000 A	0.01 ohm
		Current	

### Calibration:

### A/D converter:

### Accuracy:

### Sampling rate:

### Response time:

### Input range:

### Display & Functions

### LED:

Digital calibration by front key

16 bits resolution

DC:  $\leq \pm 0.04\%$  of FS  $\pm 1C$

AC:  $\leq \pm 0.1\%$  of FS  $\pm 1C$

15 cycles/sec

$\leq 100$  msec.(when the AvG = "1") in standard

Input High and Low programmable

R  $\uparrow$  H : Settable range: 0.00~100.00% of input range

R  $\downarrow$  L : Settable range: 0.00~100.00% of input range

Numeric: 5 digits, 0.8"(20.0mm) red high-bright LED

Relay output indication: 4 square red LED

RS 485 communication: 1 square orange LED

E.C.I. function indication: 3 square green LED

Max/Mini Hold indication: 2 square orange LED

<b>Display range:</b>	-19999~29999;
<b>Scaling function:</b>	<b>L<sub>o</sub>SC</b> : Low Scale; Settable range: -19999~+29999 <b>H<sub>i</sub>SC</b> : High Scale; Settable range: -19999~+29999 Programmable from 0 / 0.0 / 0.00 / 0.000 / 0.0000
<b>Decimal point:</b>	Extra 3 banks programmable for scaling & decimal point
<b>Banks function:</b>	Extra 3 banks programmable for scaling & decimal point
<b>Over range indication:</b>	<b>o<sub>u</sub>FL</b> , when input is over 20% of input range Hi
<b>Under range indication:</b>	<b>-o<sub>u</sub>FL</b> , when input is under -20% of input range Lo
<b>Max / Mini recording:</b>	Maximum and Minimum value storage during power on.
<b>Display functions:</b>	<b>PV / Max(Mini) Hold / RS 485 Programmable</b>
<b>Front key functions:</b>	<b>Up and down key can be set to be a function as ECI.</b>
<b>Low cut:</b>	Settable range: -19999~29999 counts
<b>Digital fine adjust:</b>	<b>P<sub>u</sub>P<sub>r</sub>o</b> : Settable range: -19999~+29999 <b>P<sub>u</sub>S<sub>P</sub>n</b> : Settable range: -19999~+29999

#### Reading Stable Function

<b>Average:</b>	Settable range: 1~99 times
<b>Moving average:</b>	Settable range: 1(None)~10 times
<b>Digital filter:</b>	Settable range: 0(None)/1~99 times

#### Control Functions(option)

<b>Set-points:</b>	Four set-points
<b>Control relay:</b>	Four relays Relay 2 & Relay 3: Dual FORM-C, 5A/230Vac, 10A/115V Relay 1 & Relay 4: Dual FORM-A, 1A/230Vac, 3A/115V

**Banks pre-set:** 4 banks pre-set for all relay functions to relative 4 difference scaling, and selectable by 3 External Control Inputs(E.C.I.) Or front key

<b>Relay energized mode:</b>	Energized levels compare with set-points: Hi / Lo / Go.12 / Go.23 / Hi.HLd / Lo.HLd; programmable <b>DO function: Energized by RS485 command of master.</b> Start delay / Energized & De-energized delay / Hysteresis / Energized Latch <b>Start band</b> (Minimum level for Energizing): 0~9999counts <b>Start delay time:</b> 0:00.0~9(Minutes):59.9(Second) <b>Energized delay time:</b> 0:00.0~9(Minutes):59.9(Second) <b>De-energized delay time:</b> 0:00.0~9(Minutes):59.9(Second) <b>Hysteresis:</b> 0~5000 counts
------------------------------	--

#### External Control Inputs(ECI)

<b>Input mode:</b>	3 ECI points, Contact or open collect input, Level trigger
<b>Functions:</b>	Relative PV(Tare) / PV Hold / Reset for Max or Mini. Hold / DI / Reset for Relay Energized latch / <b>Banks selection</b>
<b>Debouncing time:</b>	Settable range 5 ~255 x (8mseconds)

#### Analogue output(option)

<b>Accuracy:</b>	±0.1% of F.S.; 16 bits DA converter
<b>Ripple:</b>	±0.1% of F.S.
<b>Response time:</b>	≤100 msec. (10~90% of input)
<b>Isolation:</b>	AC 2.0 KV between input and output
<b>Output range:</b>	Specify either Voltage or Current output in ordering <b>Voltage:</b> 0~5V / 0~10V / 1~5V programmable <b>Current:</b> 0~10mA / 0~20mA / 4~20mA programmable <b>Voltage: 0~10V: ≥ 1000Ω;</b> <b>Current: 4(0)~20mA: ≤ 600Ω max</b>
<b>Output capability:</b>	

<b>Functions:</b>	<b>R<sub>o</sub>H5</b> (output range high): Settable range: -19999~29999 <b>R<sub>o</sub>L5</b> (output range Low): Settable range: -19999~29999 <b>R<sub>o</sub>L<sub>h</sub>5</b> (output High Limit): 0.00~110.00% of output High <b>R<sub>o</sub>P<sub>r</sub>o</b> : Settable range: -38011~+27524 <b>R<sub>o</sub>S<sub>P</sub>n</b> : Settable range: -38011~+27524
-------------------	--

#### Digital fine adjust:

#### RS 485 Communication(option)

<b>Protocol:</b>	Modbus RTU mode
<b>Baud rate:</b>	1200/2400/4800/9600/19200/38400 programmable
<b>Data bits:</b>	8 bits
<b>Parity:</b>	Even, odd or none (with 1 or 2 stop bit) programmable
<b>Address:</b>	1 ~ 255 programmable
<b>Remote display:</b>	to show the value from RS485 command of master
<b>Distance:</b>	1200M
<b>Terminate resistor:</b>	150Ω at last unit.

#### Electrical Safety

<b>Dielectric strength:</b>	AC 2.0 KV for 1 min, Between Power / Input / Output / Case
-----------------------------	--

<b>Insulation resistance:</b>	≥100M ohm at 500Vdc, Between Power / Input / Output
<b>Isolation:</b>	Between Power / Input / Relay / Analogue / RS485 / E.C.I.
<b>EMC:</b>	EN 55011:2002; EN 61326:2003
<b>Safety(LVD):</b>	EN 61010-1:2001
<b>Vibration:</b>	1~800 Hz, 3.175 g <sup>2</sup> /Hz

#### Environmental

<b>Operating temp.:</b>	0~60 °C
<b>Operating humidity:</b>	20~95 %RH, Non-condensing
<b>Temp. coefficient:</b>	≤100 PPM/°C
<b>Storage temp.:</b>	-10~70 °C
<b>Enclosure:</b>	Front panel: IEC 529 (IP52); Housing: IP20

#### Mechanical

<b>Dimensions:</b>	96mm(W) x 48mm(H) x 120mm(D)
<b>Panel cutout:</b>	92mm(W) x 44mm(H)
<b>Case material:</b>	ABS fire-resistance (UL 94V-0)
<b>Mounting:</b>	Panel flush mounting
<b>Terminal block:</b>	Plastic NYLON 66 (UL 94V-0) #A1~A3(current input): 20A/300Vac, M3.5, 12~22AWG Others: 10A 300Vac, M2.6, 16~22AWG 550g / 350g(Aux. Power Code: ADH or ADL)

#### Weight:

#### Power

<b>Power supply:</b>	AC115/230V,50/60Hz; Optional: AC 85~264V / DC 100~300V or DC 20~56V
<b>Power consumption:</b>	5.0VA maximum
<b>Back up memory:</b>	By EEPROM

## FRONT PANEL



## DIMENSIONS

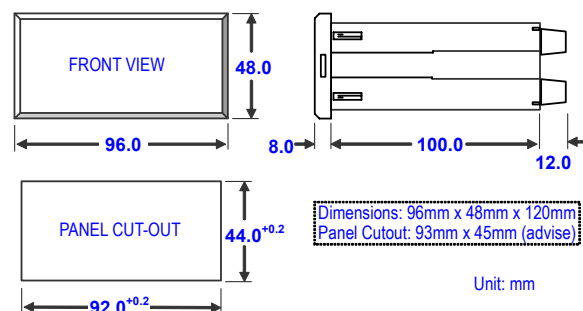

## INSTALLATION

The meter should be installed in a location that does not exceed the maximum operating temperature and provides good air circulation.

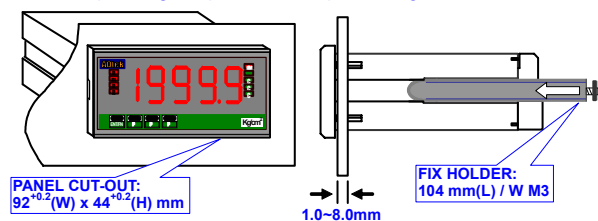

## CONNECTION DIAGRAM

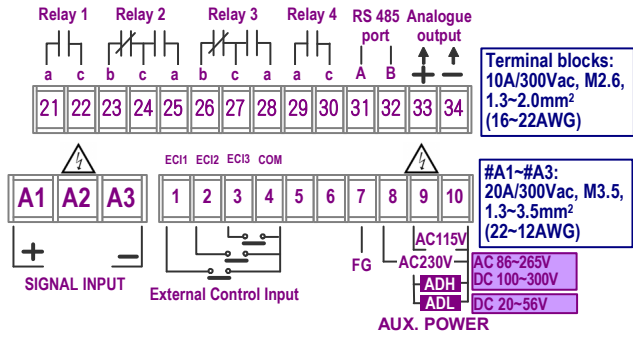

Please check the voltage of power supplied first, and then connect to the specified terminals. It is recommended that power supplied to the meter be protected by a fuse or circuit breaker.

### Power Supply

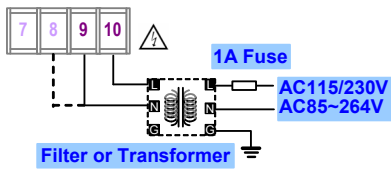

### Input connection

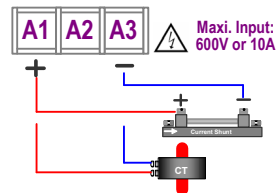

Remark:  
PT can not short in secondary.  
CT can not open in secondary.

### RS485 Communication Port

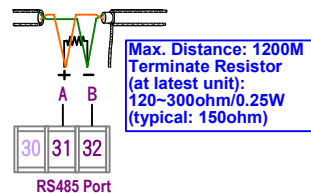

## FUNCTION DESCRIPTION

### Input & Scaling Functions

**Input range:** Analogue input High and Low programmable

The meter has to be specified and fixed according to ordering code (ex. 0~10A or 0~300V) in factory. If the meter has to install in difference range of input, the meter can be set in function [ R.Lo ] and [ R.Hi ] of input group to meet the input signal.

For example: The meter is 0~10Aac input, and the signal from sensor is 0~5Aac. Please get into [ inPUt GRoUP ] to set [ R.Hi ] (Analogue input high) to be 50.00%(10A x 50.00% = 5A), then the meter has been changed the input range to 0~5A and the all relative parameters will work base on 0~5A. The meter doesn't need re-calibration after change the [ R.Lo ] and [ R.Hi ] .

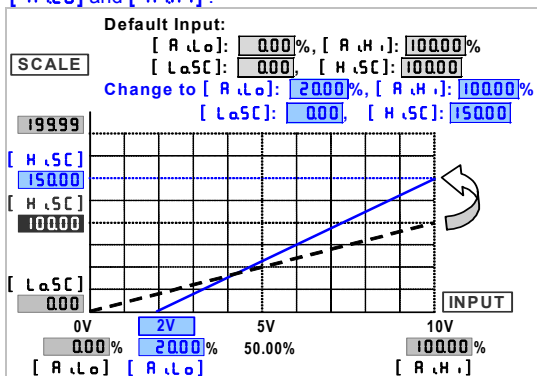

\*The setting may cause display lower resolution. Please set lower resolution when the input signal has been high compressed.

### Scaling function:

Setting the **Lo.SC** (Low scale) and **Hi.SC** (High scale) in [ inPUt GRoUP ] to relative input signal. **Reverse scaling will be done too.** Please refer to the figure as below,

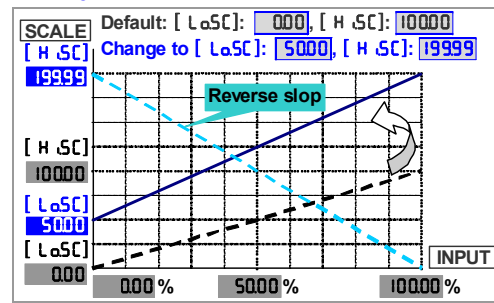

\*Too narrow scale may cause display lower resolution.

### Display & Functions

#### Max / Mini recording:

The meter will storage the maximum and minimum value in [ User Level ] during power on in order to review drifting of PV.

#### Display functions:

(Please refer to step A-09)

PV / Max(Mini) Hold / RS 485 programmable in [ d5PL Y ] function of [ inPUt GRoUP ]

Present Value **P.V.**: The display will show the value that Relative to Input signal.

Maximum Hold **Max.Hd** / Minimum Hold **Min.Hd**: The meter will keep display in maximum(minimum) value during power on, until manual reset by front key in [ User Level ], rear terminal is close [ External Control Input(E.C.I.) ] or press front down or up key to reset (according to setting, please functions of refer to the ECI Group)

▶ Please find the sticker that enclose the package of the meter to stick on the right side of square orange LED

#### Max. ( Mini ) Hold & Reset

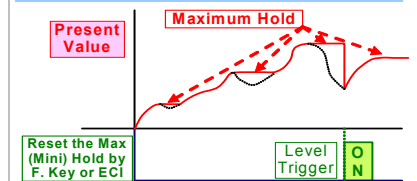

Remote Display by RS485 command **F.5485**: The meter will show the value that received from RS485 sending. In past, The meter normally receive 4~20mA or 0~10V from AO or digital output from BCD module of PLC. We support a new solution that PV shows the value from RS485 command of master can so that can be **save cost and wiring** from PLC.

PV Hold **P.V.Hd**: [ External Control Input(E.C.I.) ] can be set to be **P.V.Hd** function(Please refer to the function of ECI Group). The display will be hold, when the E.C.I. is closed.

▶ Please find the sticker to stick on the right side of square green LED.

#### PV Hold & Reset

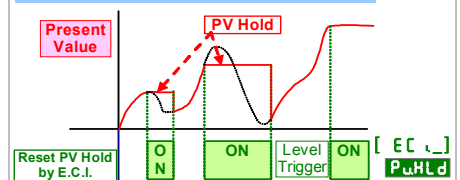

**Low cut:**

If the setting value is positive, it means when the absolutely value of PV  $\leq$  Setting value, the display will be 0. If the setting value is negative, it means when the PV under setting value (PV  $\leq$  -Setting value), the display will be setting value.

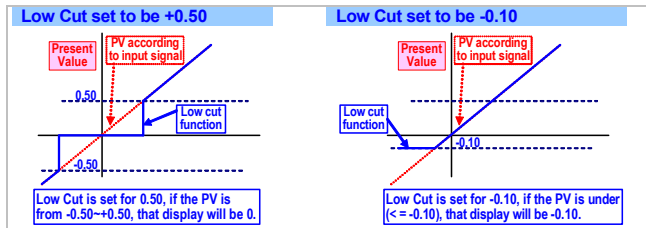

**Digital fine adjustment:**

Users can get Fine Adjustment for Zero & Span of PV by front key of the meter, and "Just Key In" the value which user want to show in the current input signals. Especially, the [Pwr0] & [PUSPn] are not only in zero & span of PV, but also any lower point for [Pwr0] & higher point for [PUSPn]. The meter will be linearization for full scale. The adjustment can be clear in function [PSECr]

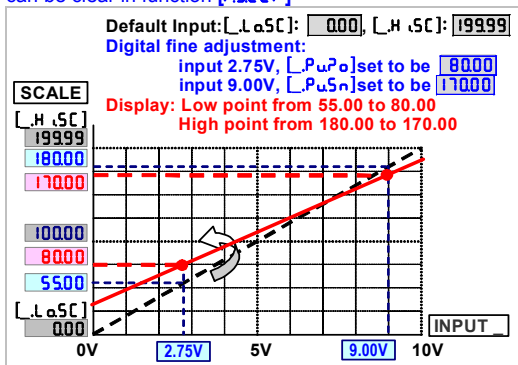

**Reading Stable Function**

**Average:**

Basically, the sampling rate of meter is 15cycles/sec. If the function set to be 3 times, It means the meter will update of display will be 5 times/sec.

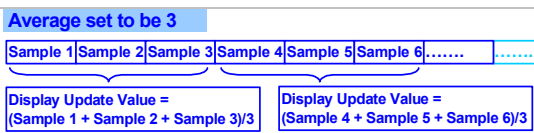

**Moving average:**

If the function to be set 3 times, the meter will update delay in first 3 samples, then it will update 15 times/sec continuously.

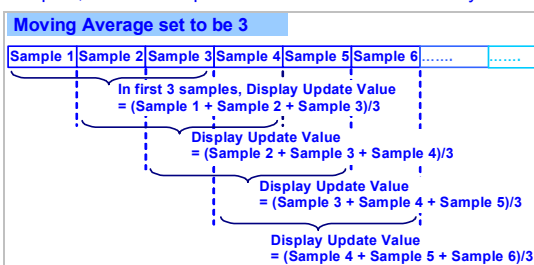

**Digital Filter:**

The digital filter can reduce the magnetic noise in field.

**Control Functions(option)**

**Relay energized mode:**

Hi / Lo / Hi.Hld / Lo.Hld / do / Go-1.2 / Go-2.3 programmable

**Hi [H] (Fig.1-0):** Relay will be energized when PV > Set Point

**Lo [L] (Fig.1-2):** Relay will be energized when PV < Set Point

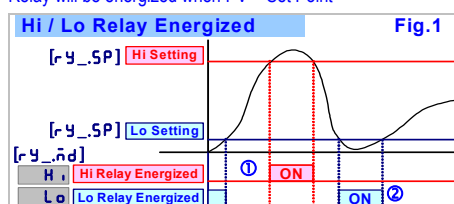

**Go-1.2 [G-1.2]:**

This function is programmable in Relay 4 only.

If the Relay 4 set to be Go function, the relay will compare with [rYISP] and [rY2SP].

Go relay energized when the condition is [rYISP] (Hi) > PV > [rY2SP] (Lo)

**Go-2.3 [G-2.3]:**

This function is programmable in Relay 4 only.

If the Relay 4 set to be Go function, the relay will compare with [rY2SP] and [rY3SP].

Go relay energized when the condition is [rY2SP] (Hi) > PV > [rY3SP] (Lo)

**Hi.Hld [H.Hld] (Lo.Hld [L.Hld]):**

When the PV is Higher (or lower) than set-point, the relay will be energized and latch until manual reset by from key in [ User Level], [External Control Input(E.C.I.)] is closed or Press front down or up key to reset (UP Key or Down Key functions have been set to be "YES").

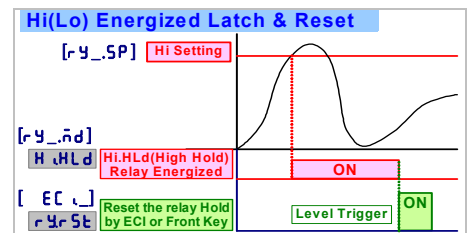

**DO function [do]:**

Energized by RS485 command of master.

The function was designed to get remote control by RS485 command of master. The typical application is to control a switch in field from computer center as like as digital output(DO) of PLC.

**Energized Functions:**

Start delay / Energized & De-energized delay / Hysteresis

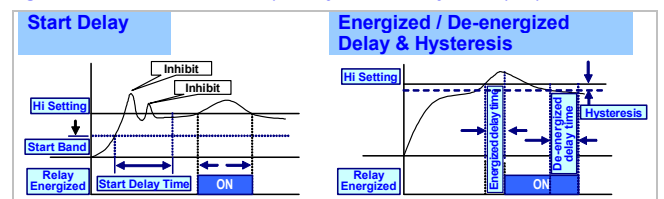

**External Control Inputs(ECI)**

The three external control inputs are individually programmable to perform specific meter control or display functions. All E.C.I. have been designed in level trigger actions. Please pay attention, the EC11 or EC12 input will be disable while UP or Down Key has been set to be "YES".

**Functions:**

Relative PV / PV Hold / Reset Max or Mini. Hold / DI / Reset for Relay Energized latch / banks selection (option) programmable.

**Relative PV [ELPu]:** The E.C.I. can be set to be [ELPu] function. When the E.C.I. is closed, the reading will show the differential value.

**PV Hold [PvHLd]:** The E.C.I. can be set to be [PvHLd] function. The display will be hold when the E.C.I. is closed, until the E.C.I. is to be open. Please refer to the below figure.

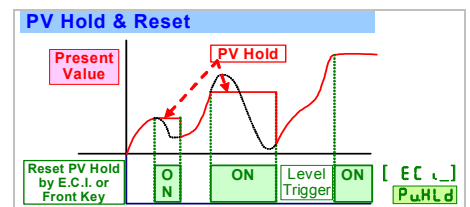

**Reset for Maximum or Minimum Hold [rSt]:**

When the [dSPLy] function in [inPUt GRoUP] selected [rSt] or [rSt], the display will show Maximum or Minimum value, and can be reset by the E.C.I. (close). Please refer to the figure as below.

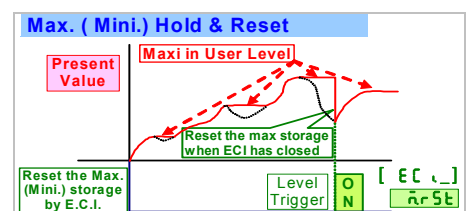

**DI [d i]:** The E.C.I can be set to be [d i] function, when the meter building in RS485 port. It is easier to get remote monitoring a switch status through the meter as like as DI of PLC.  
**Reset for Relay Energized Latch:** If relay energized mode has set to be Energized latch [H J L d] / [L o H L d], the E.C.I. can be set to be [Y r 5 t]. When the PV meets the condition of relay energizing, the relay will be energized and latch until the E.C.I. is closed.

**Debouncing time:** The function is for avoiding noise signal to into the meter. And The basic period is 8mseconds. It means you set the number that has to multiple 8mseconds. For example: [d E b n C] set to be 5, it means 5 x 8mseconds = 40mseconds

**Analogue output(option)**  
 Please specify the output type either an 0~10V or 4(0)~20mA in ordering. The programmable output low and high scaling can be based on various display values. Reverse slope output is possible by reversing point positions.

**Output range:** Voltage: 0~5V / 0~10V / 1~5V programmable  
 Current: 0~10mA / 0~20mA / 4~20mA programmable  
**Functions:** Output High / Low scale, output limit, fine adjustment  
 output range high [R o H 5]: To setting the Display value High to versus output range High(as like as 20mA in 4~20)  
 output range low [R o L 5]: To setting the Display value Low to versus output range Low(as like as 4mA in 4~20)

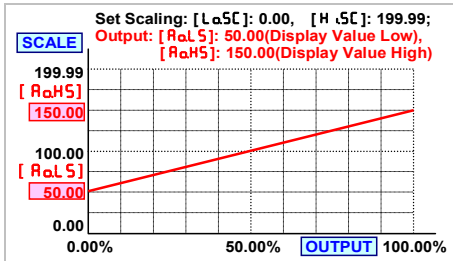

The range between [R o H 5] and [R o L 5] should be over 20% of span at least; otherwise, it will be got less resolution of analogue output.

output High Limit [R o L n t]: 0.00~110.00% of output High User can set the high limit of output to avoid a damage of receiver or protection system.

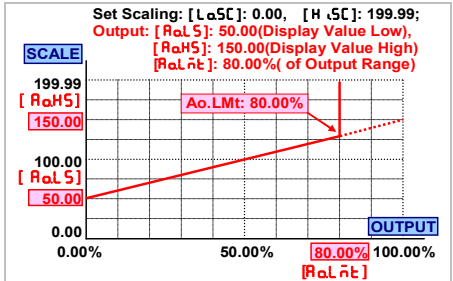

**Fine zero & span adjustment:** Users can get Fine Adjustment of analogue output by front key of the meter. Please connect standard meter to the terminal of analogue output. To press the front key(up or down key) of meter to adjust and check the output.

**AO Zero [R o Z r o]:** Fine Zero Adjustment for Analog Output; Settable range: -38011~27524;  
**AO Span [R o S P n]:** Fine Span Adjustment for Analog Output; Settable range: -38011~27524;

**RS 485 communication(option)**  
 The RS485's protocol is Modbus RTU mode, and baud rate up to 38400 bps. It's not only convenience to remote monitoring, display for reading and ECI status, but also for remote control in the case that doesn't have any DIO device in the field.

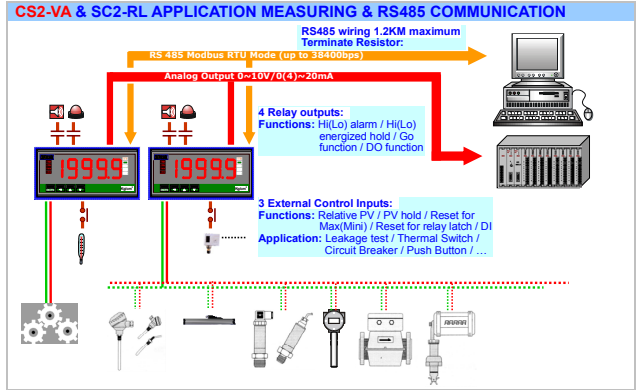

**Remote Display:** The meter will show the value that received from RS485 command. In past, The meter normally receive 4~20mA or 0~10V from AO or digital output from BCD module of PLC. We support a new solution that PV shows the value from RS485 command of master so that can be **save cost and wiring** from PLC. When the [d 5 P L Y] set to be RS485, it means, the PV screen will show the number from RS485 command & data. The data(number) will be same as PV that will compare with set-point, analogue output and ECI functions so that is to control analogue output, relay energized and so on.

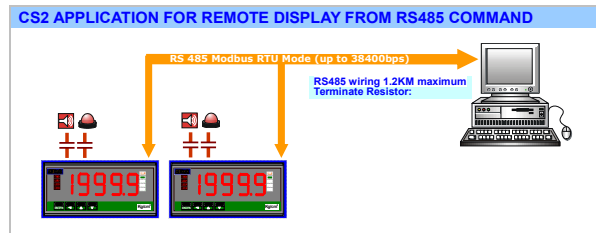

**Calibration** System calibration by front key. The process of calibration, please refer to the operating manual

**Optional Function** Customize function with quantities is welcome. Please contact with our sales for detail. The appendix code of optional function will be add behind the code of auxiliary power as like as xxx-A-HSM.

**Banks function: (appendix code: -3BK)**

- The function is for CS2 to control difference process with a same meter.
- For example; A pressure testing equipment; it has to measure multi-range with difference pressure transducers. The meter can be pre-set 4 groups parameter to show difference scale and relay energized in difference set-points. The operator just selects the bank number (bank1) by [External Control Input(ECI)] or front key operating in [User Level] to meet the process. To make easier operating and to avoid mistake in process.

## ■ ERROR MESSAGE

BEFORE POWER ON, PLEASE CHECK THE SPECIFICATION AND CONNECTION AGAIN.

SELF-DIAGNOSIS AND ERROR CODE:

DISPLAY	DESCRIPTION	REMARK
ouFL	Display is positive-overflow (Signal is over display range)	(Please check the input signal)
-ouFL	Display is negative-overflow (Signal is under display range)	(Please check the input signal)
ouFL	ADC is positive-overflow (Signal is higher than input 120%)	(Please check the input signal)
-ouFL	ADC is negative-overflow (Signal is lower than input -120%)	(Please check the input signal)
EEP ↔ FAiL	EEPROM occurs error	(Please send back to manufactory for repaired)
AiCnG ↔ Pu	Calibrating Input Signal do not process	(Please process Calibrating Input Signal)
AiC ↔ FAiL	Calibrating Input Signal error	(Please check Calibrating Input Signal)
AOcnG ↔ Pu	Calibrating Output Signal do not process	(Please process Calibrating Output Signal)
AOc ↔ FAiL	Calibrating Output Signal error	(Please check Calibrating Output Signal)

## ■ FRONT PANEL:

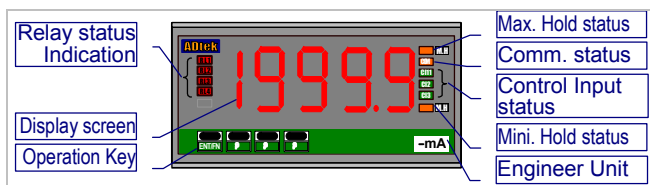

### ■ Numeric Screens

0.8"(20.0mm) red high-brightness LED for 4 2/3 digital present value.

### ■ I/O Status Indication

- **Relay Energized:** 4 square red LED
  - RL1** display when Relay 1 energized;
  - RL2** display when Relay 2 energized;
  - RL3** display when Relay 3 energized;
  - RL4** display when Relay 4 energized;
- **External Control Input Energized:** 3 square green LED
  - EC1** display when E.C.I. 1 close(dry contact)
  - EC2** display when E.C.I. 2 close(dry contact)
  - EC3** display when E.C.I. 3 close(dry contact)
- **RS485 Communication:** 1 square orange LED
  - COM** will flash when the meter is receive or send data, and **COM** flash quickly means the data transient quicker.
- **Max/Mini Hold indication:** 2 square orange LEDs
  - MH** displayed: When the display function has been selected in Maximum or Minimum Hold function.

### ■ Stickers:

Each meter has a sticker what are functions and engineer label enclosure.

- **Relay energized mode:** **HH Hi Lo LL DO**
- **E.C.I. functions mode:**
  - PV.H** PV.H(PV Hold) / **Tare** Tare / **DI** DI(Digital Input)
  - M.RS** M.RS(Maximum or Minimum Reset) /
  - R.RS** R.RS(Reset fo Relay Latch)
- **Engineer Label:** over 80 types.

- **Operating Key:** 4 keys for Enter(Function) / Shift(Escape) / Up key / Down key

	Setting Status	Function Index
Up key	Increase number	Go back to previous function index
Down key	Decrease number	Go to next function index
Shift key	Shift the setting position	Go back to this function index, and abort the setting
Enter/Fun key	Setting Confirmed and save to EEPROM	From the function index to get into setting status

- **Pass Word PCode:** Settable range: 0000~9999; User has to key in the right pass word so that get into [ Programming Level ] . Otherwise, the meter will go back to measuring page. If user forgets the password, please contact with the service window.
- **Function Lock:** There are 4 levels programmable.
  - **None none:** no lock all.
  - **User Level USEr:** User Level lock. User can get into User Level for checking but setting.
  - **Programming Level EPG:** Programming level lock. User can get into programming level for checking but setting.
  - **ALL ALL:** All lock. User can get into all level for checking but setting.
- **Front Key Function**
  - The Key can be set to be the same function as the setting of EC1. Ex. The EC11 set to be **PuHLd** and the function **[E.1=UP]** set to be **YES** in [ EC + GroUP]. When user presses Key, the PV will hold as like as EC11 close.
  - The Key can be set to be the same function as the setting of EC12. Ex. The EC12 set to be **FELPu** and the function **[E.2=dn]** set to be **YES** in [ EC + GroUP]. When user presses Key, the PV will show relative value as like as EC12 close.
- ▶ **If the front key function has been set, the terminal input for EC1 will be disabling.**

**OPERATING DIAGRAM** (The detail description of operation, please refer to operating manual.)

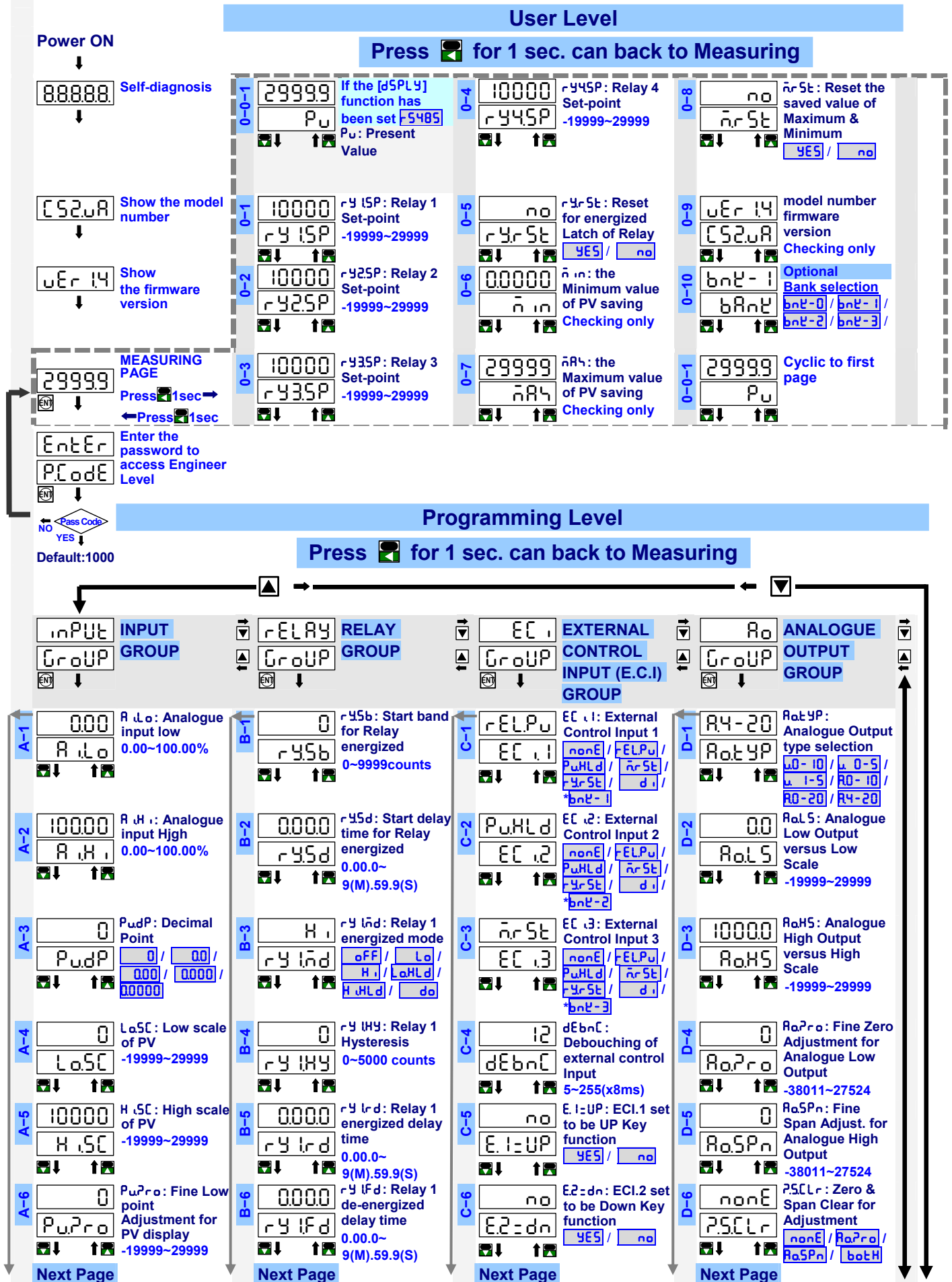

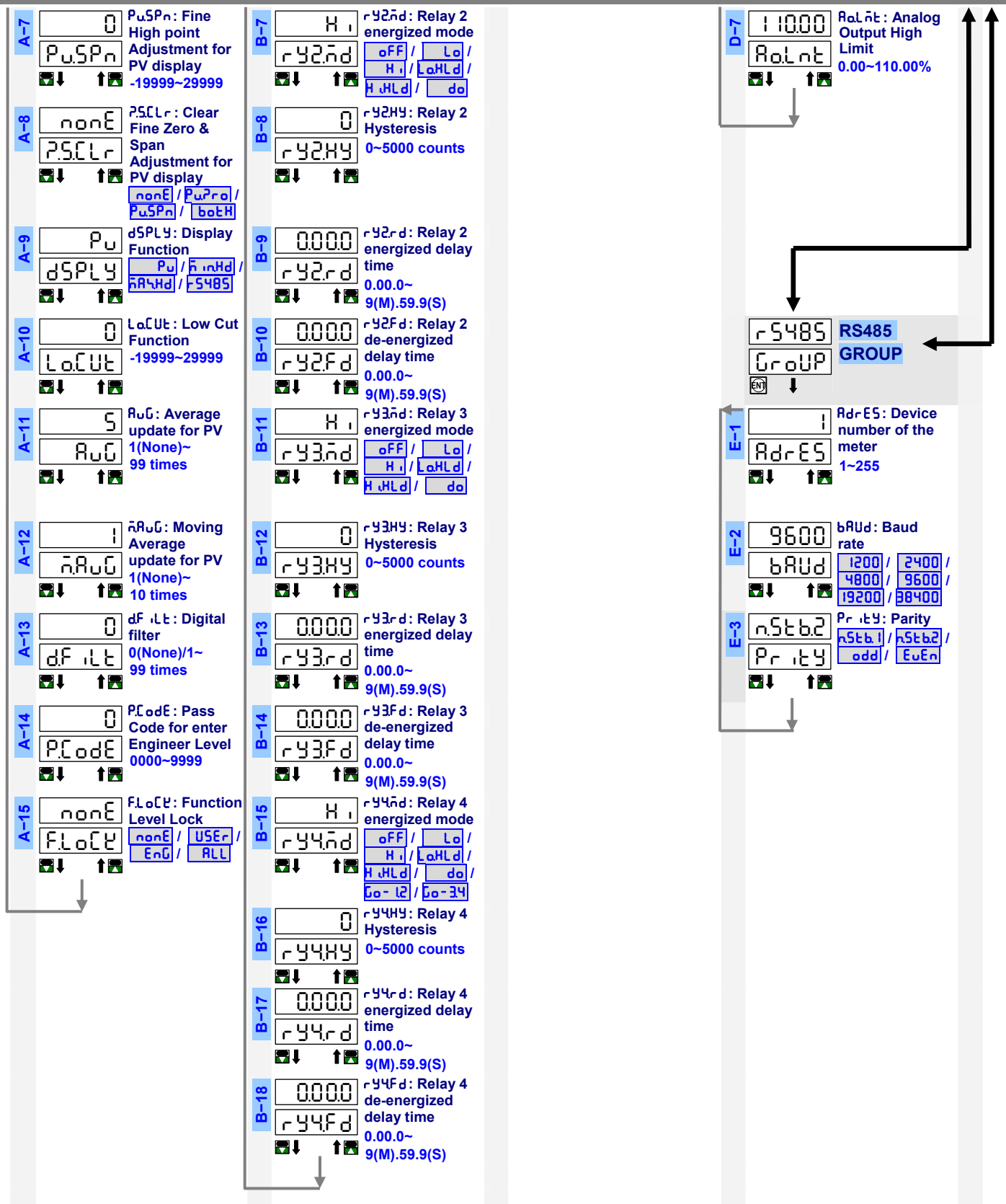

- ▶ Please refer to operating manual for detail description
- ▶ Please refer to operating manual for Banks function description and operating.