

PRODUCT NEWS 2019

LinMot[®]



LinMot completes the **PR02 Linear Rotary Motor family**

Last year the PR02-52 and the PR02-88, the middle and largest models of the PR02 linear rotary motor family, were presented. Now the smallest model of the PR02 family is coming onto the market: the PR02-38.

With a total width of only 38 mm, it represents the most compact PR02 series product and is intended for applications with limited space and sensitive assembly processes.

As usual with the PR02 family, even the smallest PR02-38 model integrates the motors responsible for the lifting and rotating motion as well as additional components in a slim housing. This latest member of the PR02 family is functionally similar to its larger counterparts and offers all the features found in the PR02 family. In addition to the linear and rotary servo motors, further options such as a magnetic spring «MagSpring», a torque sensor and a force sensor can be integrated. The MagSpring ensures that the moving load is passively compensated and prevents the axis from dropping in case of power loss. The torque and force sensors enable precise, reproducible and recordable capping and assembly processes such as those required in the pharmaceutical or medical industries.

For demanding applications and to increase flexibility, LinMot offers the hollow shaft option for all PR02 motors. This makes it easy to integrate non-rotating tappets, compressed air or vacuum feedthroughs. Compared to LinMot's PR01 linear rotary motor family, the user also benefits from the overall units' shorter installation length and the easy to clean hygienic design surfaces.

The PR02-52 has already been successfully implemented in many applications over the past year building on the tremendous success of the PR01 product line. The largest PR02-88 module is now undergoing extensive field testing and is scheduled for market launch in 1st quarter of 2019. The new PR02-38 market is planned for mid-2019.



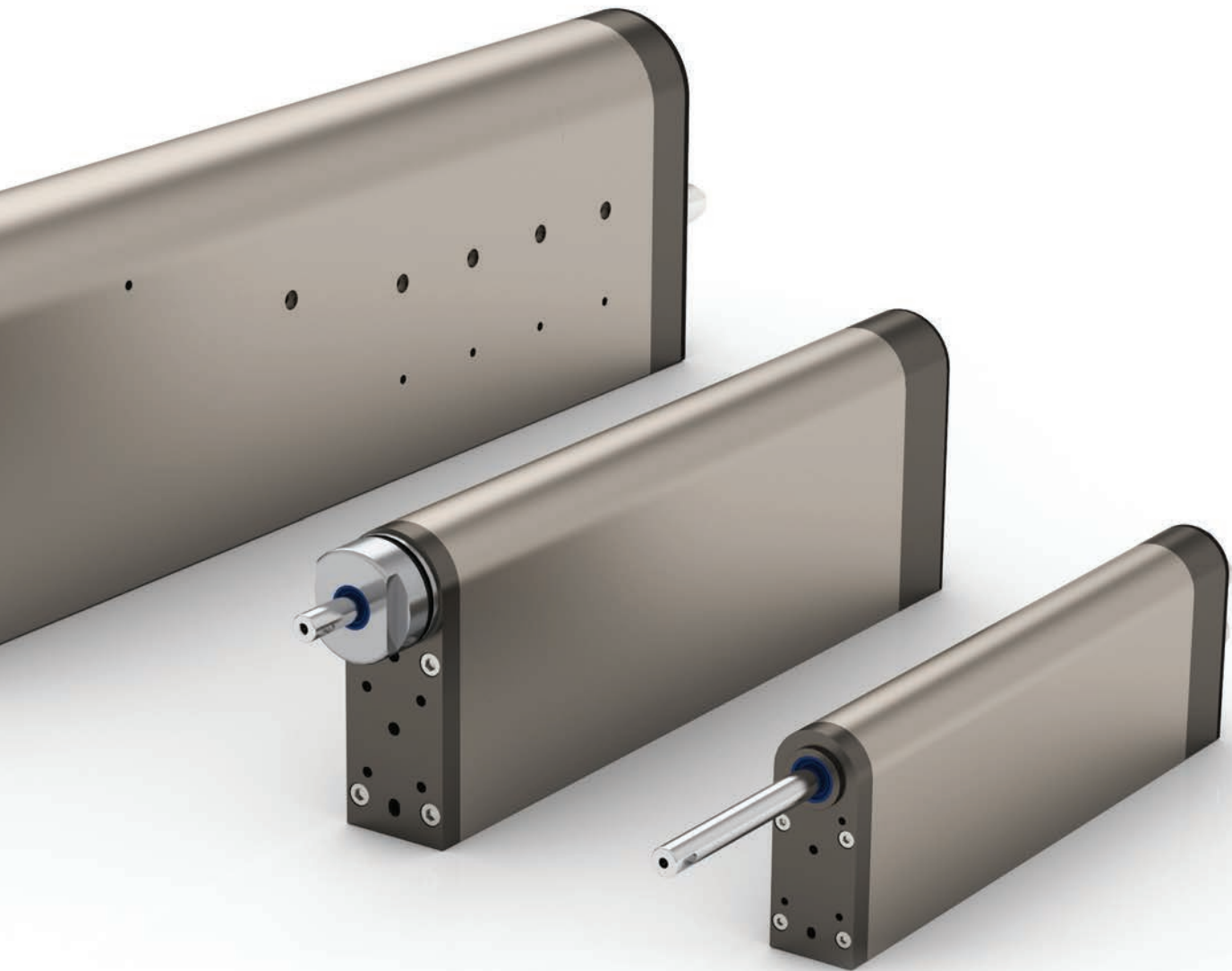

		PR02-38	PR02-52	PR02-88
Stroke up to	mm	70	100	150 / 300
Peak Force	N	67.1	255	572
Nominal Force	N	14	51	145
Peak Velocity	m/s	4.9	3.9	3
Peak Torque	Nm	1.2	2.2	12.1
Constant Torque (Halt)	Nm	0.3	0.47	3.03
Max. Number of Revolutions	rpm	1500	1500	1000
Repeatability	mm	±0.05	±0.05	±0.05
Length	mm	333	453	820 / 1105

High performance for **Linear Motors of size P01-48**



With the tremendous success of the «High-Performance» P01-23 and P01-37 series, LinMot is now launching the next larger model P01-48 in the HP “High-Performance” range.

As with the smaller -23 and -37 sizes, changes to the motor winding, the magnetic circuit and the use of high-performance materials provide decisively higher performance motor capability. The increased performance is particularly evident in the higher continuous force. The user benefits from the same dimensions as with the standard P01-48 series linear motors, while at the same time delivering more power. This allows an increase in the performance of existing machines and systems without having to revise the mechanical design. Older machines can be easily upgraded on site. The new P01-48 HP linear motors can be used to realize highly dynamic applications in a very small space without previously required forced cooling in many cases.

The new high-performance motors are available in two lengths: PS01-48x150-HP and PS01-48x240F-HP. Both models will be available starting spring 2019.

		PS01-48x150-HP	PS01-48x240F-HP
Stroke up to	mm	1830	1830
Peak Force	N	365	570
Nominal Force	N	195	300
Peak Velocity	m/s	2.7	2.9
Peak Acceleration	m/s ²	250	390
Repeatability	mm	±0.05	±0.05
Stator Length	mm	200	290
Slider Length	mm	2000	2000

LinMot motors **3x400VAC** stainless steel design



The highly successful P10-70 linear motor family is expanding: now LinMot is introducing the P10x70 3x400VAC stainless steel variants. These fully protected motors enable linear motor use in food processing & beverage machines as well as pharmaceutical & medical applications requiring extensive cleaning processes. High humidity and caustic solutions previously would wreck havoc on linear motor systems – until the introduction of the P01-37 and P01-48 stainless steel motors. Now LinMot is increasing force capacity with the introduction of this highly anticipated linear motor offering.

The INOX housing, which is completely made of stainless steel EN 1.4404/AISI 316L, ensures operational reliability in these very demanding environmental conditions. The completely welded housing encapsulates the motor from the outside, thus achieving protection class IP69K. In order to prevent the formation of condensation water in the motor, the motor housing is poured out under vacuum. This means that the motor housing is free of air inclusions inside which could form condensation water at changing temperatures. In addition, the new motors are equipped with water cooling integrated into the housing. In terms of maintenance, the user benefits from the modular design of the motors, where the bearing can be replaced very easily. Specially designed mounting flanges allow simple system and machine installation.

Functionally, the stainless steel version offers all the advantages of the P10-70 series. The proven 3x400VAC technology coupled to LinMot servo drives with direct mains supply ensure that the motors fit perfectly into new and existing machine concepts. Like the current linear motors of the P10 series, the new stainless steel motors can also be controlled via external third party drives.

Starting spring 2019, the linear motors of the P10-70 series will be available in the lengths PS10-70x160, PS10-70x 240 and PS10-70x 320, fitting into applications with strokes up to 1>530 mm and forces up to 2>180N.



Functional Safety Drives & Motors

As part of the further development of the servo drive C series, LinMot will be launching the new functional safety drives next year. These servo drives are based on the existing C1250 and C1450 series and feature additional safety functions in the new 2S version. In addition to the STO (safe torque off) and SS1 (control until standstill), which were already available in the 1S version, the new drives also offer the functions Safe Stop 2 (SS2), Safe Operation Stop (SOS), Safe Limited Speed (SLS) and Safe Brake Control (SBC/SBT). The safe brake control (SBC) has been even extended by a brake test (SBT) in which the braking effect can be checked cyclically.

In a first version, the controllers are equipped with Profisafe safety busses via PROFINET and PROFIdrive. In the future, safe bus communication and safe bus protocols will also be available via EtherCAT, EtherNET IP, Powerlink and Sercos. In the meantime, all of the functions described above can be activated via the safe digital inputs. In addition, a safe two-channel output is available.

For the implementation of functional safety solutions, LinMot linear motors with safe encoders will also be offered from summer 2019. The external appearance of the motors (stators and sliders) remains unchanged. The new motors do not require an additional sensor and are also connected to the drive with the familiar single-cable solution for safe drive control. The new servo drives are additionally equipped with a safe hipurface DSL encoder input for safe control of rotary motors. This encoder input requires only two lines and makes it possible to use a single-cable solution for the safe control of rotary motors.





The functional safety drives C1250 / 1450 in the 2S version with PROFINET and PROFIdrive will be available from summer 2019.

STO: Safe Torque Off



SS1: Safe Stop 1

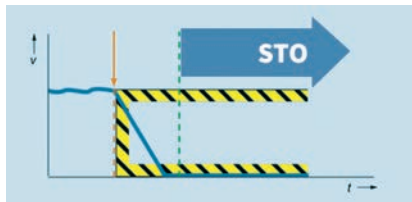

SS2: Safe Stop 2

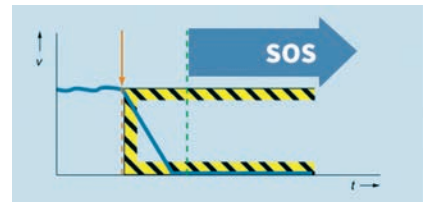

SLS: Safe Limited Speed



SOS: Safe Operation Stop



SBC: Safe Break Control

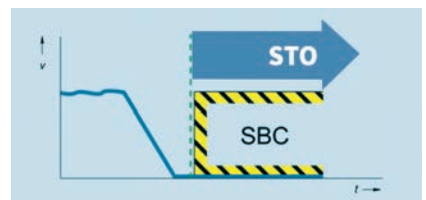

LinMot 2-Axis “Close by” Drive D2251

Continuing the highly dynamic innovation cycle, LinMot presents a new servo drive for the control of 2 axes in a compact IP65 housing. As a decentralized solution, this drive can be placed close to the drive component, which significantly reduces the space required in the control cabinet.

As a 2-axis drive, the D2251 series was specially developed for the LinMot linear rotary motors, however can also be used for decentralized control of LinMot linear motors or rotary motors.

The drive can be operated with 24-72VDC and guarantees a phase current of up to 25 A for the motor. Industrial Ethernet interfaces for PROFINET, EtherNet/IP, EtherCAT, SERCOS III and POWERLINK will be offered. The device profiles CoE (CiA402), SoE (SERCOS over EtherCAT), PROFIdrive and EtherNet/IP CIP Sync will also be supported. The bus protocols are simply selected via a DIP rotary switch guaranteeing the machine manufacturer the greatest possible flexibility. With PROFINET, EtherNet/IP, EtherCAT and SERCOS III, the drive can be configured directly via the Industrial Ethernet interface.

The D2251 drive is protected against dust and water in accordance with protection class IP65 and requires no additional cover. All operating elements, switches and interfaces as well as the status display are mounted behind a transparent protective cover, thus providing the required protection for decentralized installation.

The D2251 2-axis drives will be available starting mid-2019.



LinMot Servo Drives with **CIP Sync™**

In cooperation with Rockwell, LinMot has added CIP Sync™ to the EtherNet/IP interface to its C1250 series servo drives. This allows LinMot linear motors, the controller and the entire axis system to be synchronized easily and accurately. In addition to the data packets sent by the controller, time information is now also recorded and processed by the servo drive.

CIP Sync™ enables very precise synchronization accuracy between two or more LinMot and Rockwell servo axes in one system. CIP Sync™ provides the increased control coordination required for servo applications where absolute time synchronization is critical to achieve real-time synchronization between distributed intelligent servo axes. For easy integration, LinMot provides the user with pre-programmed instructions (AOI). These instructions pre-define the composition of the data packet in terms of parameter channel, timestamp, position, velocity and acceleration. This guarantees fast and uncomplicated commissioning by the user.

The CIP Sync™ extension can be found on the LinMot C1250 series servo drives with the -CM suffix. The devices are planned for 2nd quarter 2019 market introduction.

In addition to the additional function CIP Sync™, the C1250 Drives provide further benefits, including ProfiNet, EtherNet/IP, EtherCAT, Sercos III, allowing drive configuration directly via the Industrial EtherNet interface. The CiA402, SoE and PROFIdrive profiles are also supported. The servo drives can be optionally equipped with the -1S (Safe Torque Off) variant and feature «Plug and Play» automatic motor detection interface.



LinMot provides the shortest way from **design** to **parts list**

Starting spring 2019, the LinMot e-Catalogue will be available with a new automatic part list generation tool. A new interface between the proven LinMot Designer mechanical design program and the extensively used LinMot e-Catalogue will be implemented.

All technical information on LinMot products can already be accessed clearly and conveniently via the LinMot e-Catalogue. The appropriate accessories are listed for each product and the individual components can be combined in the shopping basket to form complete system inquiries.

The LinMot Designer design program calculates the desired parameters required for the customers' application motion sequences then displays the parameters in relation to the selected base components such as linear motor, servo drive and other accessories.

With a simple push of a button, LinMot Designer will transmit to the e-Catalogue the selected linear motor and servo drive capacities. The user then selects the preferred product variants and makes additional desired selections and options.

The parts list for a complete linear drive system with all of the appropriate components and accessories for the design created in LinMot Designer is then displayed. At the end, the user has the option to download as a BOM (Bill Of Material) in CSV format or request a quotation directly within the e-Catalogue.

From design to a complete bill of material & quotation – the easiest way to create a LinMot high performance linear or rotary motion system will now be realized with LinMot Designer and e-Catalogue integration.

LinMot Designer Motor Design Program

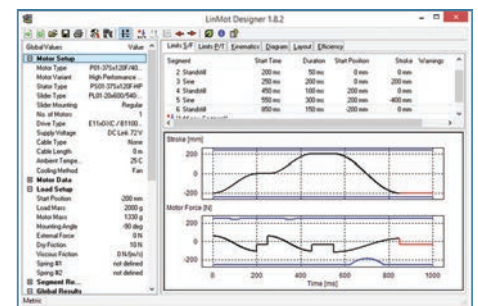

e-Catalogue

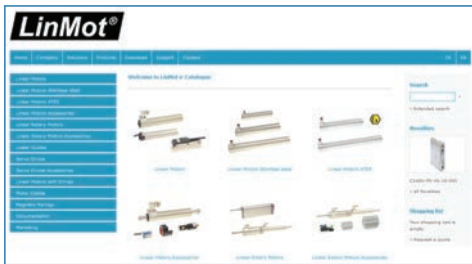

Selection of the product variant and the desired accessories

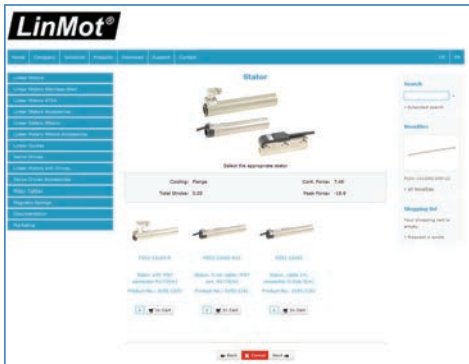

Download BOM list or direct offer request via e-Catalogue

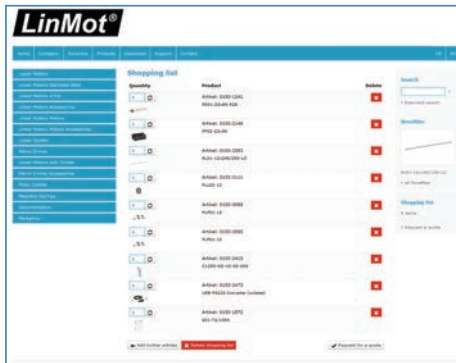

Safely closed

Closure processes can be made much more flexible and efficient with direct-drive linear-rotary motors than with systems that rely on lift cams, pneumatic cylinders, or ballscrew drives to produce the linear motion. For filling and packaging applications, where great precision and process reliability are needed, LinMot has now brought to market linear-rotary motors with integrated sensors. They are not only extremely reliable and precise, but also collect process data for every closure operation.



Excessive variation in closure force, torque, or press force means that the entire package unit needs to be scrapped. A deviation of just a few millinewton-meters from the specified torque is often enough to trigger this scenario.

Such tough requirements are placed on the closure process by a rising number of applications in the food and beverage industry. The demand for exceptionally delicate solutions is growing accordingly. Variant production, zero-defect processes, and modern, data-hungry industry 4.0 concepts also see to it that screwdriving and assembly processes need to be more flexible and better controlled than ever before.

This means that the torque and angle of rotation of the rotary drive, and the feeding force and position of the linear drive, are always known at any time during the combined linear-rotary motion, so they can be precisely controlled.

LinMot has now presented a completely new series concept for linear-rotary motors, with unprecedented monitoring and precision execution of linear-rotary operations.

GREATER PRECISION WITH INTEGRATED MEASUREMENT

The new PR02 series of motors not only combines a linear motor and a servomotor in a common housing, it also provides more space for additional optional features. Users can order the rotary motor with an integrated torque sensor and a force sensor. This means that the actual values achieved for the process parameters of torque, angle of rotation, stroke position, and feed force can be captured and verified continuously with high resolution, reproducibility, and precision.

The precision of the force and torque sensors on the PR02-52 model motor, now available in series (100 mm max. stroke, 255 N max. feed force, 2.2 Nm max torque) meets or exceeds 1% of the nominal value. With the optional torque measurement shaft, with a measurement range of 2.5 Nm, the accuracy of the measurement results is (+/-) 0,025 Nm. Values collected in this way can be used to document every closure operation in detail, or for additional process analysis. And can be transmitted directly from the motor to the PLC via an analog signal interface, or by the servocontroller

via fieldbus. They are available there to set up closed-loop control circuits or for additional analysis.

ONLINE DIAGNOSTICS AND TROUBLESHOOTING

The values can be evaluated online or offline to gain insight into the closure process. It is possible to tell for every application not only whether a screw is too tight or too loose, but also whether it is the wrong size, bent, cross-threaded, or stripped. Missing washers can be detected, as can broken workpieces and tools. Values that change slowly indicate that maintenance of the mechanical components is imminently necessary, or that the tool is worn.

Because motion profiles direct drives can be freely programmed, and the sensor data is available in real time, any faults that occur can be corrected immediately as needed, or the packaging unit can be rejected automatically or prepped for rework. An improperly installed closure can be unscrewed again immediately to shorten rework time or make disposal easier.

By eliminating external sensors, and their associated wiring and moving parts (such as cable trays), they simplify the design and maintenance of the closure system. When the linear-rotary motor is installed vertically, the machine designer can also install compensation for the moving load without additional external components. This prevents the axis from dropping when the power is off, as the motor housing also has space for a MagSpring magnetic spring. The LinMot designers have even incorporated a vacuum/compressed air pass-through in the book-shaped, hard-anodized housing of the PR02-52, just 399x135x50 mm in size. Despite its concentrated power, it has no cooling fins, angles, or cavities that are hard to clean, which means this motor is perfect for use in a clean-room environment.

RELIABLE DATA DUE TO REDUNDANCY

The end user also benefits from the high level of integration of the LinMot solution. The screwdriving system is significantly less complex, requires less space, and can be replaced more simply and quickly in case of a failure. The reduced number of parts also means failures are less likely and logistics are simpler.

But even more important for safety-related applications is that the data from the integrated sensors can be verified using redundant information from the servocontroller current data. For example, if a torque sensor provides a value for the torque that does not match the specified value used to actuate the rotary motor, then there may be a defect in the torque measurement shaft that might have remained undetected without the redundancy.

A PRODUCT FAMILY WITH A FUTURE

If you don't need such delicate closure motions or reliable sensor data for your application, you can leave the optional sensors off of the PR02 motor, or use the PR01 series of linear-rotary motor. In both cases, the specified values for the motion components are available from the servocontroller. The two series of motors do not have overlapping applications, due to their different form factors (PR02: linear and rotary motors in parallel; small, thick book format; PR01: linear and rotary motors in line; slim, cylindrical form factor), so LinMot is continuing to expand both series.

The company has announced the PR02-88 for the fall of 2018. This linear-rotary motor has a maximum stroke of 300 mm, nominal force of 145 N, and torque of up to 8.9 Nm. This makes it perfect for applications such as trigger and pump-spray closures. Also planned for the fall is the launch of the LinMot PR02-38 as a smaller version of the PR02-52. It is perfectly suited for lighter pick & place, bending, and press-on operations. In parallel with this, the PR01 family is being expanded with the PR01-70 linear-rotary motor. This model is somewhat more compact but has nearly identical force parameters as the PR01-84, which has been available for a while.



Closure application with the PR02 linear-rotary motor

Routing valuable fish portions using linear motors

Separating and routing delicate fish portions to various product channels at high speed is a challenging job. Valka, an Icelandic high-tech company that designs and builds progressive systems for fish processors, is equipping its grading and sorting machinery with LinMot stainless steel motors for the speed and accuracy demanded in a difficult washdown environment.

Valka's processing systems include several automated units grading, cutting, portioning and batching fish products. A key part of the system is a portion grader that automatically sorts pieces into various product channels and streams. "When designing this system, several criteria had to be considered", says Ivar Meyvantsson Product development manager at Valka. "First of all accuracy, secondly speed and thirdly our customers work in a washdown environment. LinMot's stainless steel linear motors provide an excellent combination of benefits in all of the categories."

ACCURATE SORTING WITH NO MARGIN FOR ERROR

Sorting into production streams is typically preceded by automated cutting of fish fillets into pre-defined pieces.

As the pieces enter the portion grader, they lie tight up against each other. The spatial precision of the linear motion arm has a significant impact on the ability to accurately pick a specific piece from the conveyor. "With LinMot's excellent position repeatability, we can be certain that we pick the right pieces. While pneumatic actuators have several benefits for food processing environments and can be fast, they do not offer positional accuracy. Error in the location can lead to pieces being missed or different pieces being dragged along into the wrong product stream. In addition, a high degree of motion control helps minimize damage to the raw material." Ivar continues.



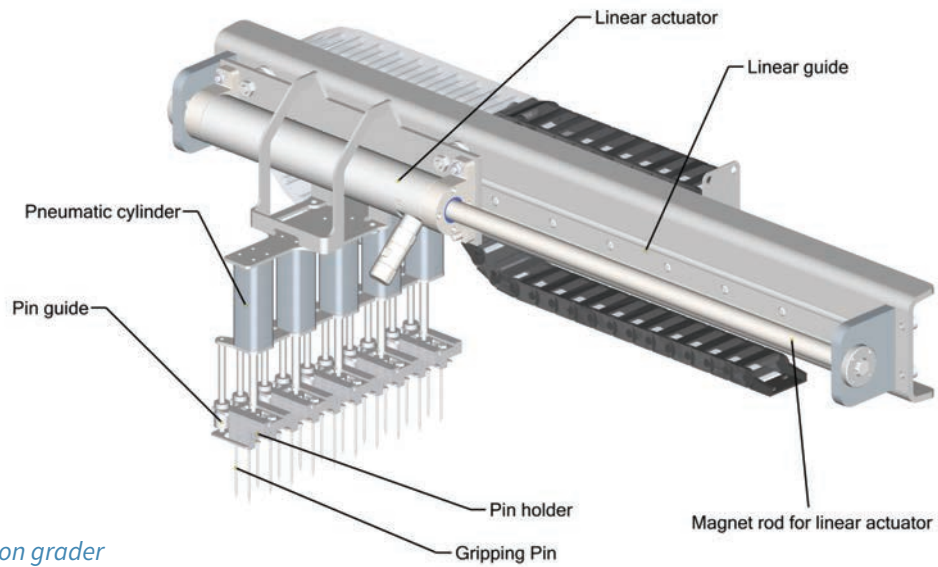

Overview of Valka's portion grader

SPEED IS CRITICAL AND COMPACTNESS IMPORTANT

The production lines utilize high-speed conveyor belts. The speed of the linear actuator pulling the pieces from the conveyor correlates directly with the overall production capacity of the manufacturing line. High-speed actuators enable the product to be carried at a higher speed through the machine without risk of missing pieces. If pieces are missed, they run to the end of the line, where an operator must manually sort pieces into the correct product streams, thereby increasing operating cost significantly. "While ball-screw systems provide high accuracy, they tend to be a lot slower than LinMot's actuators and also take up a lot more room", Ivar continues.

Another point to consider is that the production facility real estate is valuable. The more production equipment that can be fitted in the available space, the higher the capacity for production. Compact actuators help keep the footprint of our system at a minimum.

WASHDOWN AREAS IN FISH PROCESSING ARE AMONG THE MOST DIFFICULT

Last but not least, cleanliness is the critical consideration for fish processing. All the components in the Valka systems must both enable easy cleaning and tolerate aggressive pressure washing and cleaning solutions. Simple geometries and robust housing help on both fronts. "Regarding cleaning, other linear actuator designs tend to have crevices that are hard to clean, and many are not available with IP-69k rating ensuring protection against high-pressure spray-down." Says Ivar finally.

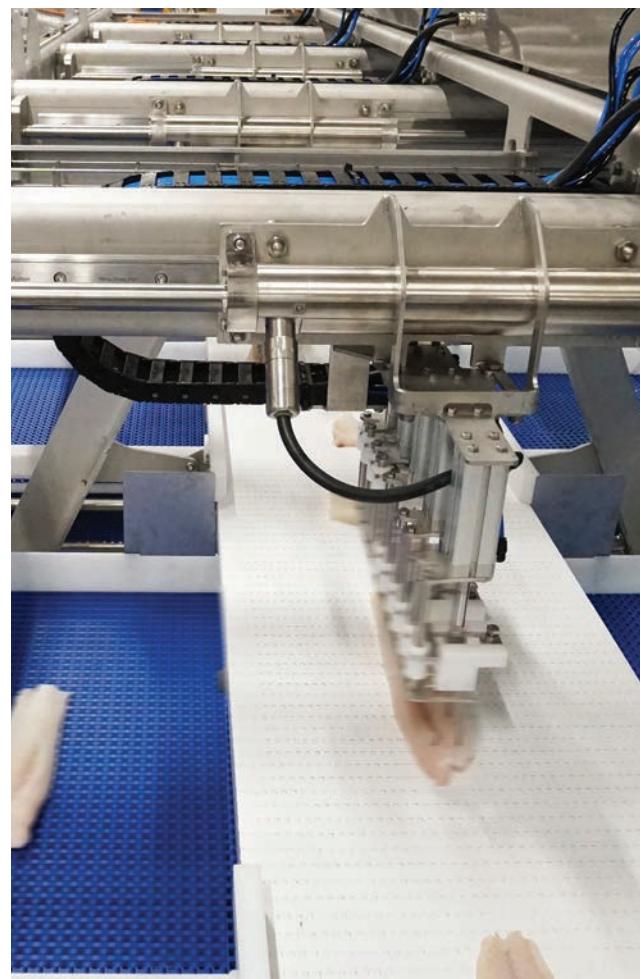

Realisation of the portion grader with a LinMot stainless steel motor

LinMot Europe

NTI AG - LinMot & MagSpring
Bodenaeckerstrasse 2
CH-8957 Spreitenbach
Switzerland

☎ +41 (0)56 419 91 91
📠 +41 (0)56 419 91 92

✉ office@linmot.com
🏠 www.linmot.com

LinMot USA

LinMot USA, Inc.
N1922 State Road 120, Unit 1
Lake Geneva, WI 53147
United States

☎ 262-743-2555

✉ usasales@linmot.com
🏠 www.linmot-usa.com

LinMot®

