

The ultimate cobot gripper

Kenos® KCS Gripper

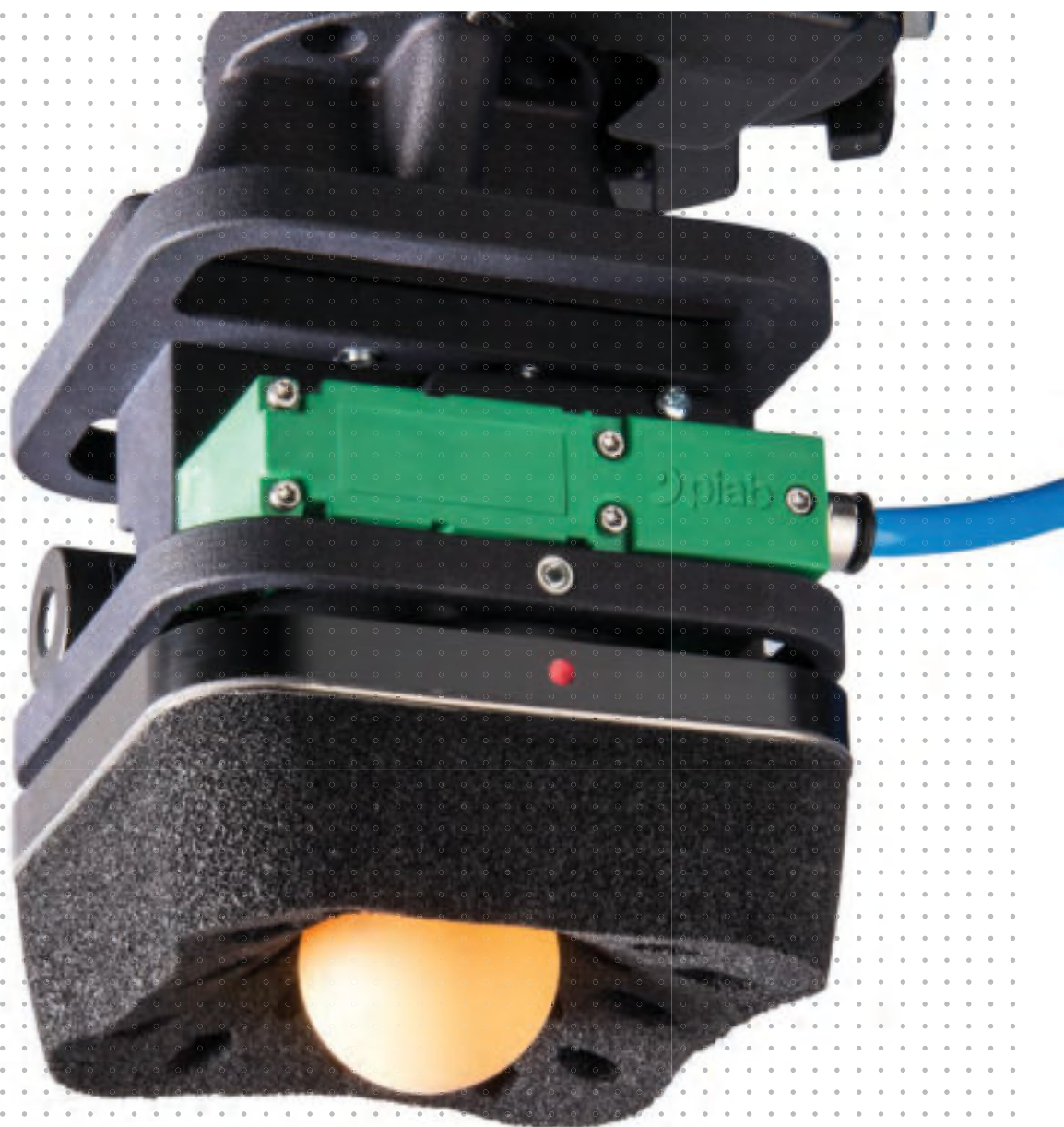



Stay Flexible - with the Kenos® KCS Gripper

For cobots to make processes more efficient, they must be as flexible as possible. Supporting the growing cobot market - an easy entry solution into automation technology - Piab has developed a single end effector for handling objects of just about any material, surface and shape.

In an environment of ever shorter product life cycles, a growing product mix and a continuous quest for individualized products, the use of an automation tool like the cobot in as many areas as possible is crucial for a profitable business. It plays an essential role in how flexible the cobot can handle things. Especially in the large application field of providing parts for processing by humans, the end effector is central. With the new compact Kenos® KCS vacuum gripper, Piab has taken exactly these requirements into account.

The Kenos® KCS gripper is an all-rounder and offers a unique level of flexibility when it comes to picking up objects. It allows for a wide range of use thereby eliminating the need for retooling. Thus, the cobot is ready for immediate use at different processes, ensuring optimal usage of its capacity. Paired with time and cost savings achieved through shorter downtimes and the lack of need for retooling, the Kenos® KCS gripper allows for a quick return on investment.

The concept is rounded up by features like its lightweight structure, powerful integrated air-driven COAX®SX cartridge vacuum technology as well as control valve and vacuum sensors access options turning the Kenos® KCS gripper into a plug-and-play system.

Lightweight Flexible Powerful

The Kenos® KCS gripper consists of a separate pump unit that integrates modular vacuum generation in the smallest of spaces with a gripper unit. Both are connected by a quick-change system. The entire unit can be attached to all common cobot models with a respective adapter.

SAVE LOAD CAPACITY FOR YOUR HEAVYWEIGHTS

With its body 3D printed in high quality SLS technology, the Kenos® KCS gripper is extremely lightweight. This allows customers to make the most of their cobot load carrying capacity - providing for extra weight to be lifted, moved and placed.

KEEP MOVING - EVERYTHING, EVERYWHERE, EVERYTIME

The main gripper consists of a technical foam, which can adapt to a wide variety of contours and can thus accommodate different parts flexibly. This eliminates in many cases the need for accurate identification of a workpiece as well as the gripping surfaces. When the foam layer is worn, it can simply be exchanged - without needing to replace the entire gripper.

GET MORE FOR LESS - HIGHER POWER AT LOWER INPUT

The pump unit is equipped with Piab's powerful new generation COAX® SX cartridge vacuum technology. The lightweight pump unit is a small, integration-optimized vacuum pump and was selected because of its almost silent operation, making it ideal for use directly next to the operator. Because COAX® ejectors are up to twice as fast as other ejectors and deliver three times more flow than a conventional ejector with identical air consumption, the pump unit can deliver high performance even with low or fluctuating supply pressure.* This makes them particularly energy efficient. Accordingly, their use reduces the cost of providing compressed air and thus the total cost of production.

*Independent comparison tests at the Fraunhofer Institute for Machine Tools and Forming Technology IWU in Dresden have shown that the Piab ejectors require significantly lower compressed air to achieve the same output compared to ejectors from other manufacturers.

TURN YOUR COBOT INTO YOUR WORKER'S BEST FRIEND

Both gripper units are characterized by their edgeless design. Due to the rounded sides and the surface of technical foam, possible injury hazards are largely eliminated. This makes the gripper units particularly safe to use on cobots, which cooperate freely with humans and thus increases the acceptance by the employees.



All Features and Options at a Glance



PLUG-AND-PLAY - COMPACT AND LIGHT, THE KCS HAS ALL IT TAKES

The Kenos® KCS pump unit has everything needed already included - the powerful vacuum components, sensor technology, silencer and optional valve technology - requiring only a single mounting and connection step to the cobot. The connection to the Rethink Robotics brand cobots Clicksmart system is directly possible, for others adapters are available.

SMALL BUT POWERFUL - PUMP UNIT WITH COAX®SX CARTRIDGES

The pump unit is equipped with Piab's newest generation COAX®SX ejectors - providing high performance even at low or fluctuating feed pressures. It can be modified to double the unit's output easily if processes change.



QUIET SYSTEM, HAPPY EMPLOYEES - THANKS TO THE SILENCER

Reducing the noise of operation the silencer ensures a pleasant work environment with the lowest audible strain possible when the vacuum unit is in operation. The digital or analog vacuum sensor above the silencer provides the "part present" signal to the cobot, when an object is taken.

WHEN SPEED MATTERS - OPTIONAL BLOW-OFF VALVE

In case a fast product release is essential to production processes or to enhance efficiency, Piab can supply an optional blow-off valve allowing for fast vacuum reduction to speed-up product placement.



YOUR CHOICE - CONFIGURABLE VALVE UNIT

For installations on a new cobot without its own valves, Piab can provide a configured valve unit. For deployment with an existing robot equipped with an valve unit simply connect to your own.

MADE TO FIT ALL - ISO NORMED ADAPTERS FOR EASY ATTACHMENT

Choose between ISO normed adapters to easily attach the Kenos® KCS gripper to any cobot type you may be using - or planning to deploy.



TIME IS MONEY - CHANGE GRIPPERS IN THE BLINK OF AN EYE

The quick change system allows to exchange grippers with a simple twist - reducing downtime for retooling to a few seconds. For security it is equipped with a metal threaded insert to lock the system.



THE ALL-ROUNDER - TECHNICAL FOAM FOR A UNIVERSAL GRIP

The technical foam can easily adapt to almost any surface or shape. As a flow reduction version it treats products very gently while maintaining a reliable grip during movement.



KEEP IT SIMPLE AND CLEAN - WITH FDA APPROVED FOAM

For direct handling of food, the gripper can also be equipped with a special FDA-approved silicon technical foam. To maintain utmost flexibility for sensitive product handling, the general technical foam can be used as an intermediate layer.

LET IT SWING - SPECIAL BAG GRIPPER LIFTING UP TO 2 KG / 4.4 LBS

For special applications, such as the handling of plastic bags of concentrates or granulates, Piab has developed another gripper unit, which can be swiftly exchanged via the quick-change system.



Kenos[®] KCS Foam Gripper

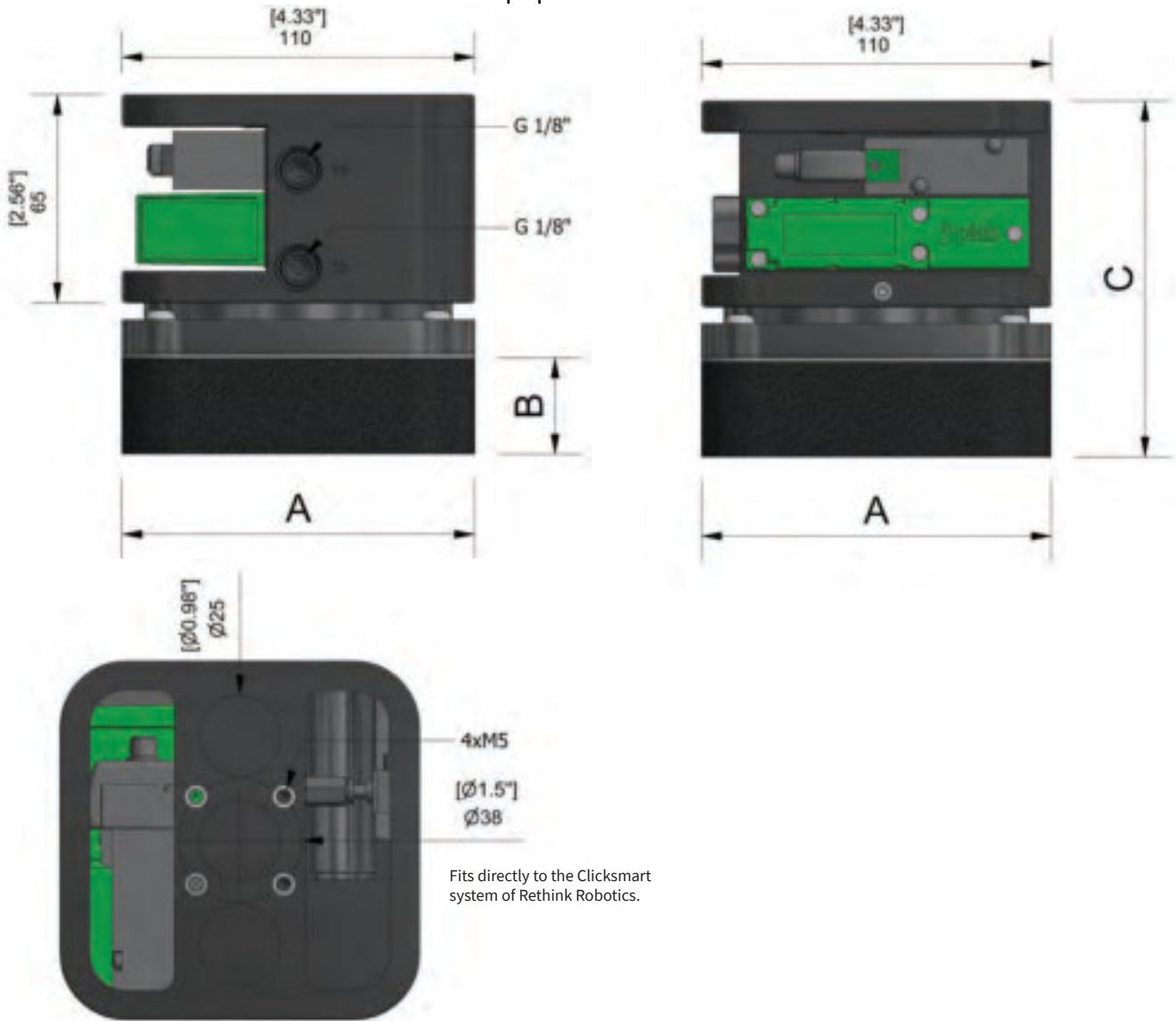

FOAM GRIPPER

Type	A mm / [inch]	B mm / [inch]	C mm / [inch]	Weight kg / [lbs]
KCS.Q110.XXX.110	110 / [4.33"]	10 / 20 / 30 [0.39"] / [0.79"] / [1.18"]	92 / 102 / 112 [3.62"] / [4.02"] / [4.41"]	0.76 [1.67]
KCS.Q110.XXX.150	150 / [5.91"]	10 / 20 / 30 [0.39"] / [0.79"] / [1.18"]	87 / 97 / 107 [3.42"] / [3.82"] / [4.21"]	0.94 [2.07]

GRIPPING FORCE OF THE KENOS[®] KCS FOAM GRIPPER

Theoretic gripping force on a rigid and stable surface with a completely covered module, without safety factor.

Type	Force, N / [lbf], at vacuum level of						
	30%	40%	50%	60%	70%	80%	90%
KCS.Q110.XXX.110 with step 1	81 / [18.2]	109 / [24.5]	136 / [30.6]	163 / [36.6]	190 / [42.7]	217 / [48.8]	244 / [54.9]
KCS.Q110.XXX.150 with step 1	136 / [30.6]	181 / [40.7]	226 / [50.8]	271 / [60.9]	317 / [71.3]	362 / [81.4]	407 / [91.5]

Kenos[®] KCS Bag Gripper

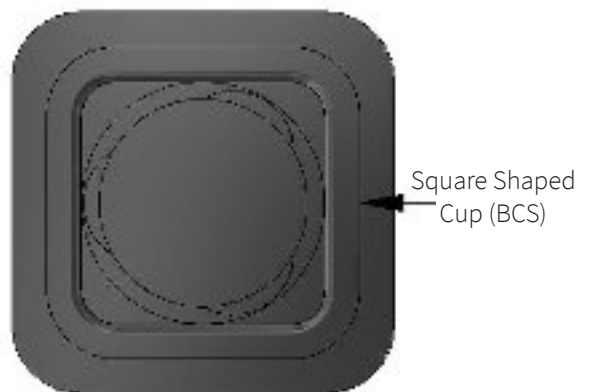
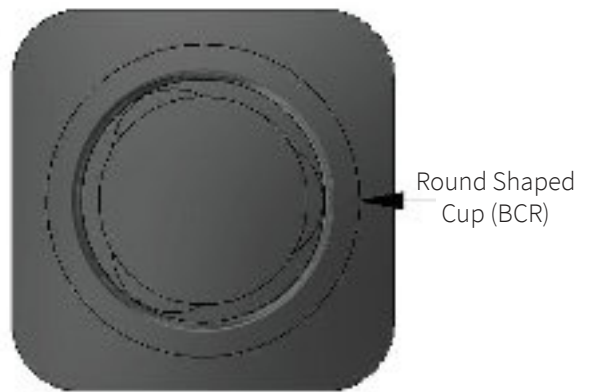
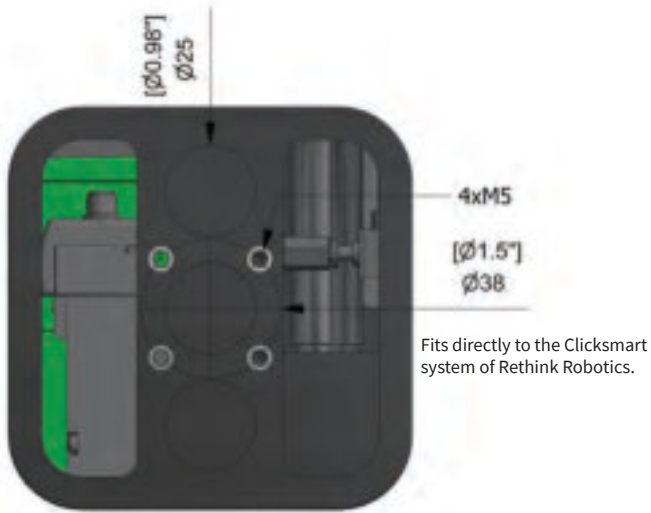
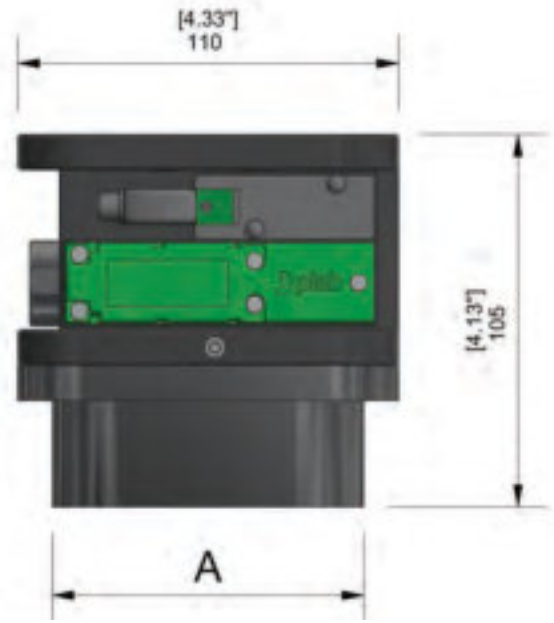
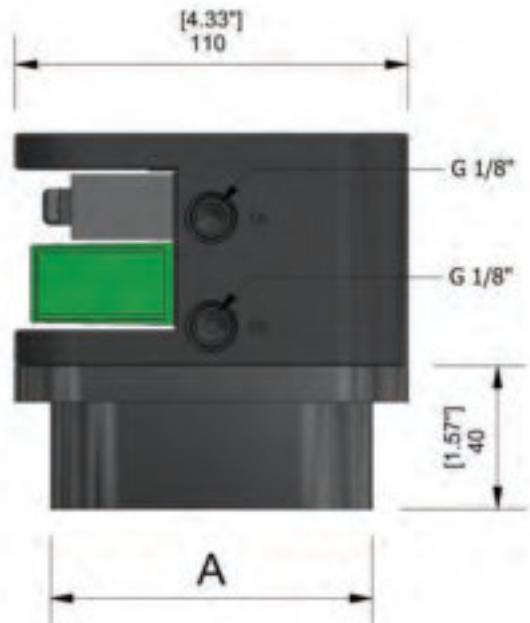

SQUARE SHAPED CUP (BCS)

Type	A mm / [inch]	Weight kg / [lbs]
KCS.Q110.BCS.90	90 / [3.54"]	0.76 / [1.67]
KCS.Q110.BCS.110	110 / [4.33"]	0.88 / [1.94]

ROUND SHAPED CUP (BCR)

Type	A mm / [inch]	Weight kg / [lbs]
KCS.Q110.BCR.90	ø90 / [ø3.54"]	0.74 / [1.63]

Kenos® KCS Gripper -ISO Standard Fixing Interface

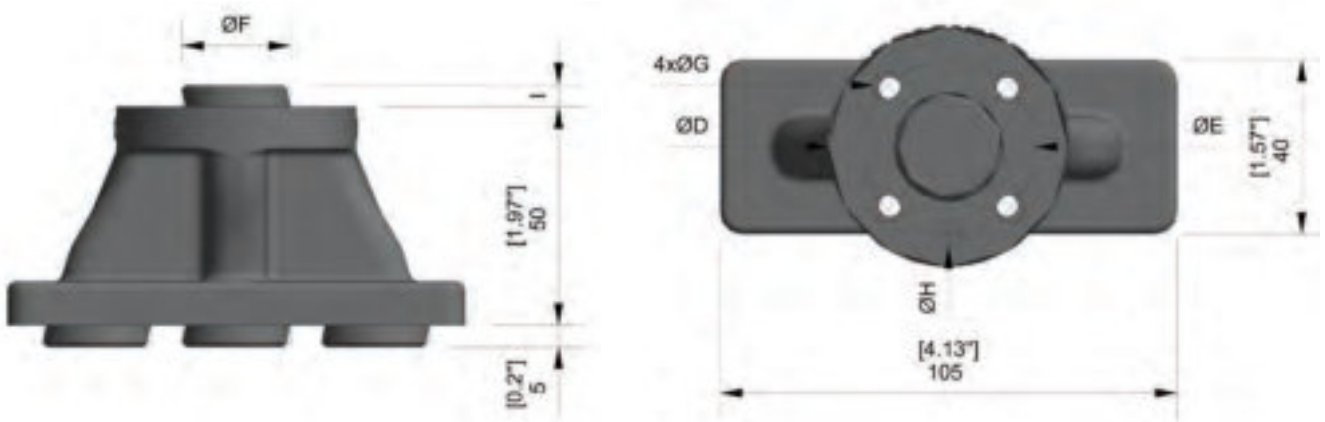

Type	E mm / [inch]	F mm / [inch]	G mm / [inch]	H mm / [inch]	I mm / [inch]	Weight g
FIX-KCS-ISO9409-1-31.5-4-M5	31.5 / [1.24"]	19.85 / [0.78"]	5.4 / [0.21"] SCREW ISO 4762 M5	5 / [0.20"]	2.85 / [0.11"]	88.33
FIX-KCS-ISO9409-1-40-4-M6	40 / [1.57"]	25 / [0.98"]	6.4 / [0.25"] SCREW ISO 4762 M6	6 / [0.24"]	5 / [0.20"]	104.17
FIX-KCS-ISO9409-1-50-4-M6	50 / [1.97"]	31.5 / [1.24"]	6.4 / [0.25"] SCREW ISO 4762 M6	6 / [0.24"]	5 / [0.20"]	115.76

Other interface options available upon request.

Kenos® KCS Gripper - General Technical Data

Description	Unit	COAX®			
		SX12 x 1	SX12 x 2	SX42 x 1	SX42 x 2
Feed pressure, optimum	MPa / [psi]	0.5 / [72.5]	0.5 / [72.5]	0.5 / [72.5]	0.5 / [72.5]
Max vacuum at optimum pressure	-kPa / [-inHg]	85 / [25.0]	85 / [25.0]	90 / [26.6]	90 / [26.6]
Air consumption at optimum pressure	NI/s / [scfm]	0.72 / [1.53]	1.44 / [3.05]	2.21 / [4.68]	4.42 / [9.37]
Max vacuum flow at optimum pressure	NI/s / [scfm]	1.22 / [2.59]	2.44 / [5.17]	[3.46 / [7.33]	6.92 / [14.7]

Order Information

KENOS® KCS FOAM GRIPPER

The top line (black) gives an example of an order number.

KCS	Q110	N	3	0	1	110	FR6	SX422	V1	MD	40
Kenos® Cobot Solution	Dimension Pump Unit mm / [inch]	Type	Foam Thickness mm / [inch]	Filter	Step	Dimensions mm / [inch]	Flow Reduction Unit Technology	Ejector Type SX plus no. of cartridges	Control Valves	Monitoring	Fixing Interface
	Q110 = 110 x 110 mm [4.33"x4.33"]	N = EPDM Foam	3 = 30 mm [1.18"]	0 = without	1 = Fine step	110 = 110x110 mm [4.33"x4.33"]	FR6 = 0.6 mm [0.024"] (standard)	SX421 = 1 cartridge SX42	X = Without solenoid valves	X = Without vacuum switch sensor	X = Without
			2 = 20 mm [0.79"]	1 = with		150 = 150x150 mm [5.91"x5.91"]	FR8 = 0.8 mm [0.03"]	SX422 = 2 cartridges SX42	V1 = EV vacuum N.C.	MD = Vacuum switch	40 = ISO 9409-1-40-4-M6
			1 = 10 mm [0.39"]					SX121 = 1 cartridge SX12	V2 = EV vacuum N.C. / EV blow off	MA = Analog 1-5 V sensor	50 = ISO 9409-1-50-4-M6
								SX122 = 2 cartridges SX12	V3 = EV vacuum N.O.		

KENOS® KCS BAG GRIPPER

The top line (black) gives an example of an order number.

KCS	Q110	BCR	90	SX422	V1	MD	40
Kenos® Cobot Solution	Dimension Pump Unit mm / [inch]	Bag Cup	Dimension mm / [inch]	Ejector Type SX plus no. of cartridges	Control Valves	Monitoring	Fixing Interface
	Q110 = 110 x 110 mm [4.33"x4.33"]	BCR = Round shape	90 = 90 x 90 mm [3.54"x3.54"]	SX421 = 1 cartridge SX42	X = Without solenoid valves	X = Without vacuum switch sensor	X = Without
		BCS = Square shape	110 = 110 x 110 mm [4.33"x4.33"]	SX422 = 2 cartridges SX42	V1 = EV vacuum N.C.	MD = Vacuum switch	40 = ISO 9409-1-40
				SX121 = 1 cartridge SX12	V2 = EV vacuum N.C. / EV blow off	MA = Analog 1-5 V sensor	50 = ISO 9409-1-50
				SX122 = 2 cartridges SX12	V3 = EV vacuum N.O.		

All information and technical data provided in this brochure is subject to change without prior notice.

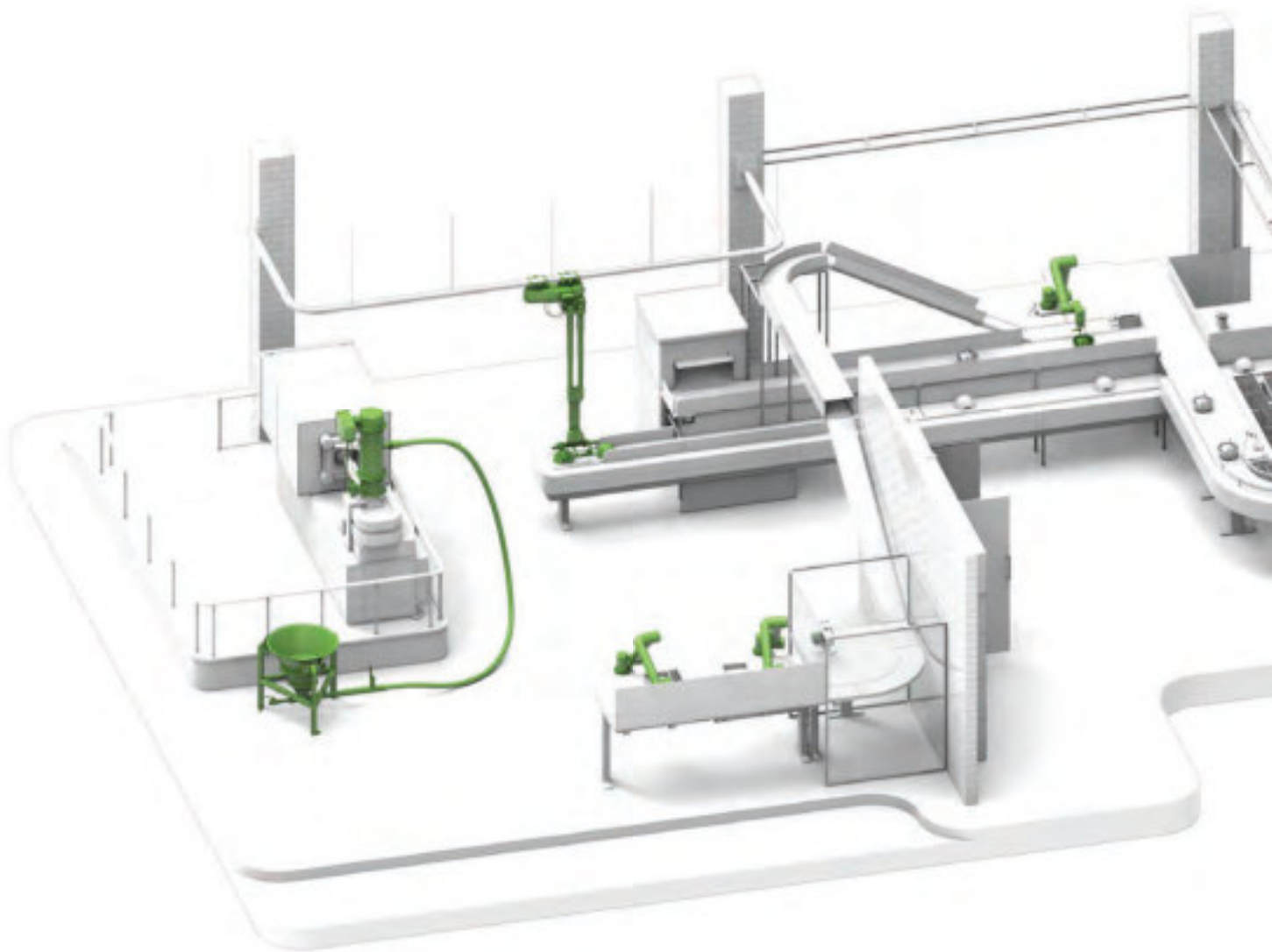

Piab - Your Gripping and Moving Solutions Provider

Piab provides smart solutions for the automated world, helping thousands of end users and machine producers in e-commerce logistics, food, pharma, automotive and other manufacturing industries to improve energy-efficiency, productivity and working environments. With 430 employees and SEK 1bn in sales 2017, Piab is a global organization, serving

customers in almost 70 countries from a network of subsidiaries and distributors. By leveraging the ongoing technological development in automation and robotics, and targeting high-growth segments and geographies, Piab's vision is to become the global leader in gripping and moving solutions.

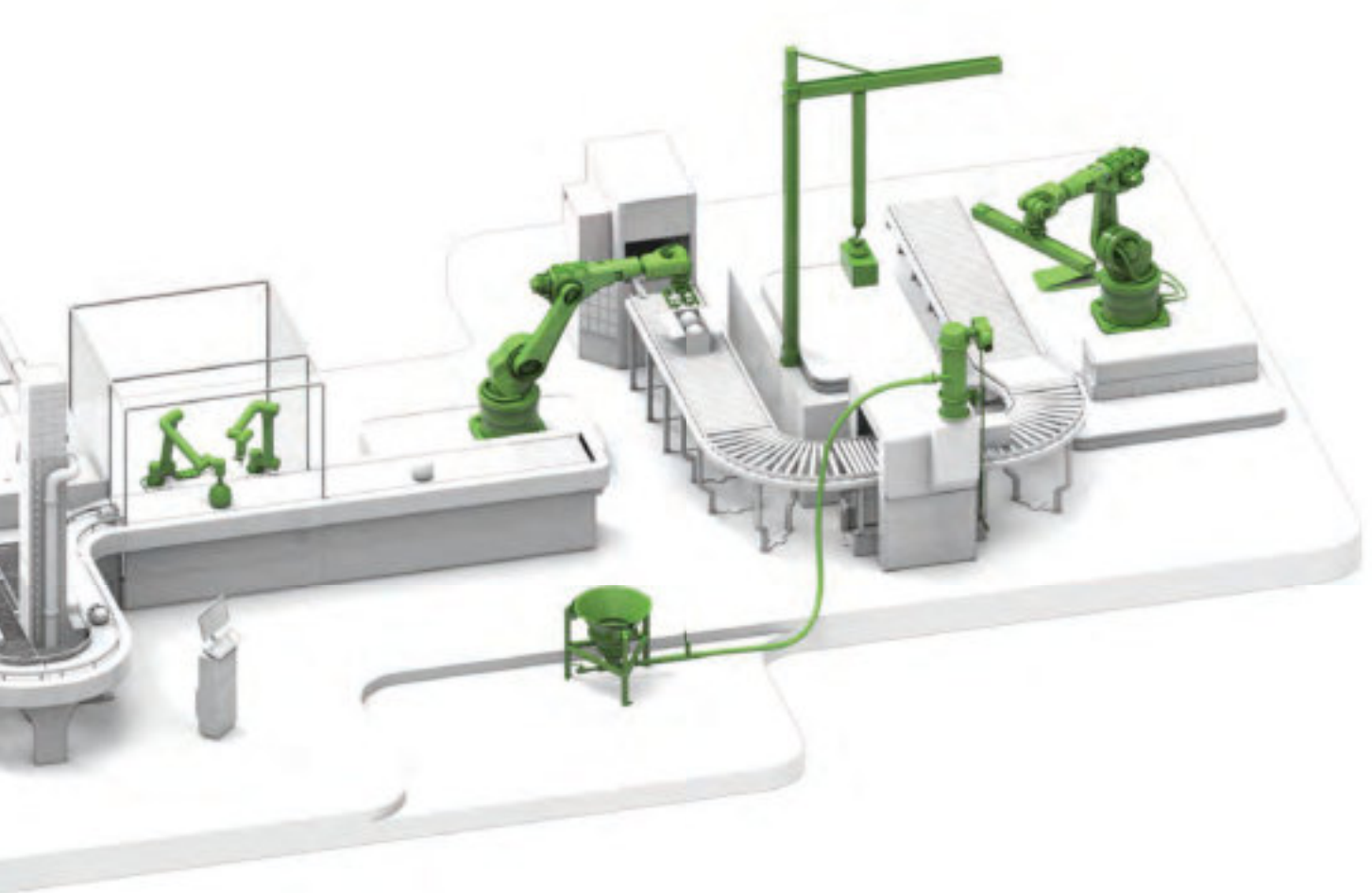

More Great Piab Product Innovations

CBG - CUSTOMIZABLE BAG GRIPPER

Design your own vacuum gripper for bags and pouches in just two minutes with Piab's user friendly software. A 3D-printed gripper with piGRIP® suction cups will be delivered to you.



piCOMPACT®23 - THE SMART PUMP

The innovative vacuum generator with fully integrated controls for smart manufacturing - suction cup holds in emergency but does not self-adhere, boosts energy efficiency at optimal vacuum.



piSMART® - INDUSTRY 4.0 READY

Building on intelligent features already available in some of Piab's vacuum equipment, piSMART® will offer a new level of control that underpins the pillars of Industry 4.0.



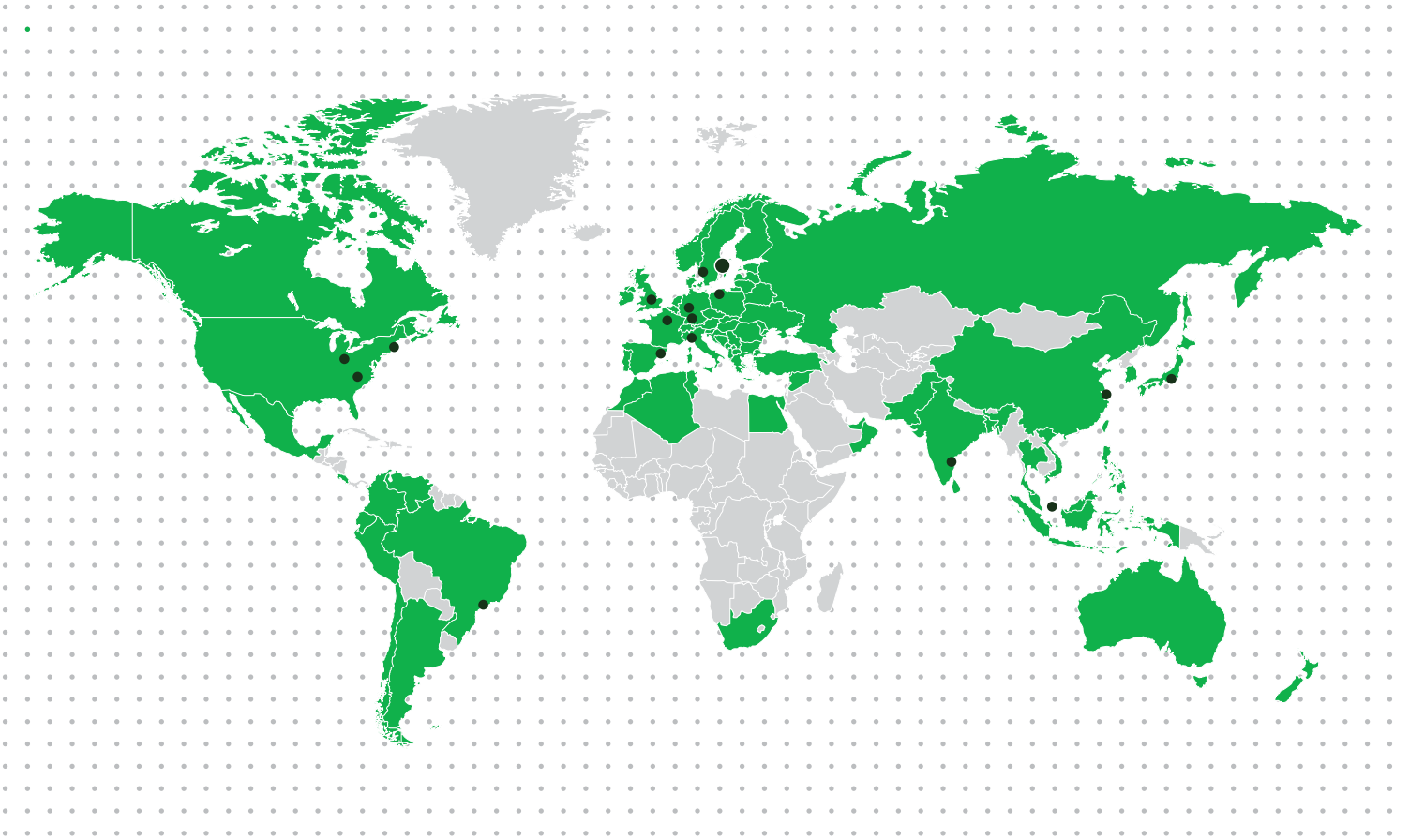

www.piab.com

BRAZIL – Sao Paulo
 Phone: +55 11 4492 9050
 Email: info-brasil@piab.com

CANADA – Hingham MA (US)
 Phone: +1 781 337 7309
 Email: info-usa@piab.com

CHINA – Shanghai
 Phone: +86 21 5237 6545
 Email: info-china@piab.com

FRANCE – Lagny sur Marne
 Phone: +33 1 6430 8267
 Email: info-france@piab.com

GERMANY – Butzbach
 Phone: +49 6033 7960-0
 Email: info-germany@piab.com

GERMANY – Schmallenberg
 Robotic gripping
 Phone: +49 (0) 29 72/962 17-11
 Email: info-germany@piab.com

MEXICO – Hingham MA (US)
 Phone: +1 781 337 7309
 Email: info-mxca@piab.com

INDIA – Chennai
 Phone: +91 9444 25 36 48
 Email: info-india@piab.com

ITALY – Torino
 Phone: +39 011 226 36 66
 Email: info-italy@piab.com

JAPAN – Tokyo
 Phone: +81 3 6662 8118
 Email: info-japan@piab.com

POLAND – Gdansk
 Phone: +48 58 785 08 50
 Email: info-poland@piab.com

SPAIN – Barcelona
 Phone: +34 93 6333876
 Email: info-spain@piab.com

SINGAPORE
 Phone: +65 6455 7006
 Email: info-singapore@piab.com

SWEDEN – Stockholm (HQ)
 Phone: +46 8 630 25 00
 Email: info-sweden@piab.com

SWEDEN – Mölndal
 Ergonomic handling
 Phone: +46 31 67 01 00
 Email: info-sweden@piab.com

UNITED KINGDOM – Loughborough
 Phone: +44 1509 857 010
 Email: info-uk@piab.com

USA – Hingham (MA)
 Phone: +1 781 337 7309
 Email: info-usa@piab.com

USA – Xenia (OH)
 Robotic gripping
 Phone: +1 888 727 3628
 Email: info-usa@piab.com

USA – Charlotte (NC)
 Ergonomic handling
 Phone: +1 704 527 5052
 Email: info-usa@piab.com