



AIR DRIVEN GAS BOOSTERS

TYPE B160 / TYPE B200

Single acting, Double acting and Two stage



Available in ATEX version

CONTENTS

- Operating principle of Resato air-driven gas boosters types B160 and B200
- Introduction
- Advantages of the Resato air-driven gas booster types B160 and B200
- Why use an air-driven gas booster
- Operating the Resato air-driven gas booster
- How to select the right Resato gas booster
- Dangerous gases
- Atex
- Gas booster selection information:
- Installation
- Resato gas boosters B160 and B200 material specifications
- Standard range performance of the high-pressure sealing
- Accessories

PRINCIPLE OF RESATO AIR-DRIVEN BOOSTERS TYPE B160 AND B200

Resato air-driven boosters operate on the simple but efficient principle of an automatic reciprocating differential area piston. A relatively large air-operated drive piston (160 or 200 mm) directly coupled by a connecting rod to a small gas piston that operates in a high pressure gas cylinder section, converts compressed air flow into high pressure gas flow. Each gas cylinder end contains high-pressure inlet and outlet check valves. The air drive section is fitted with the unique Resato air-operated cycling valve that has no mechanical pilot valves, ensuring low noise operation. Cooling of the high-pressure gas cylinder section of the booster takes place by routing the cold exhausted drive air through a jacket surrounding the gas cylinder and, with the two-stage model, through an intercooler on the interstage line. This also significantly improves overall efficiency

INTRODUCTION

Resato offers a complete range of single, double acting and two-stage gas boosters. The boosters are available in various ratios. The higher the ratio the higher the output pressure of the booster.

Single acting boosters only have one gas cylinder. Double acting boosters have two identical gas cylinders for a higher output flow. For higher compression ratios, e.g. relative high output pressure at relative low inlet pressure, two-stage boosters are used. These boosters have two different gas cylinders, each with a different ratio.

The complete range is available in type B160 for normal flow rates and in type B200 for higher flow rates and higher pressures.

Resato gas boosters are suitable for transfer and pressurization of a wide range of gases, e.g. Nitrogen, Helium, CO₂, Argon and Breathing air. For use with other gases contact Resato for information on possible booster modifications and installation instructions.

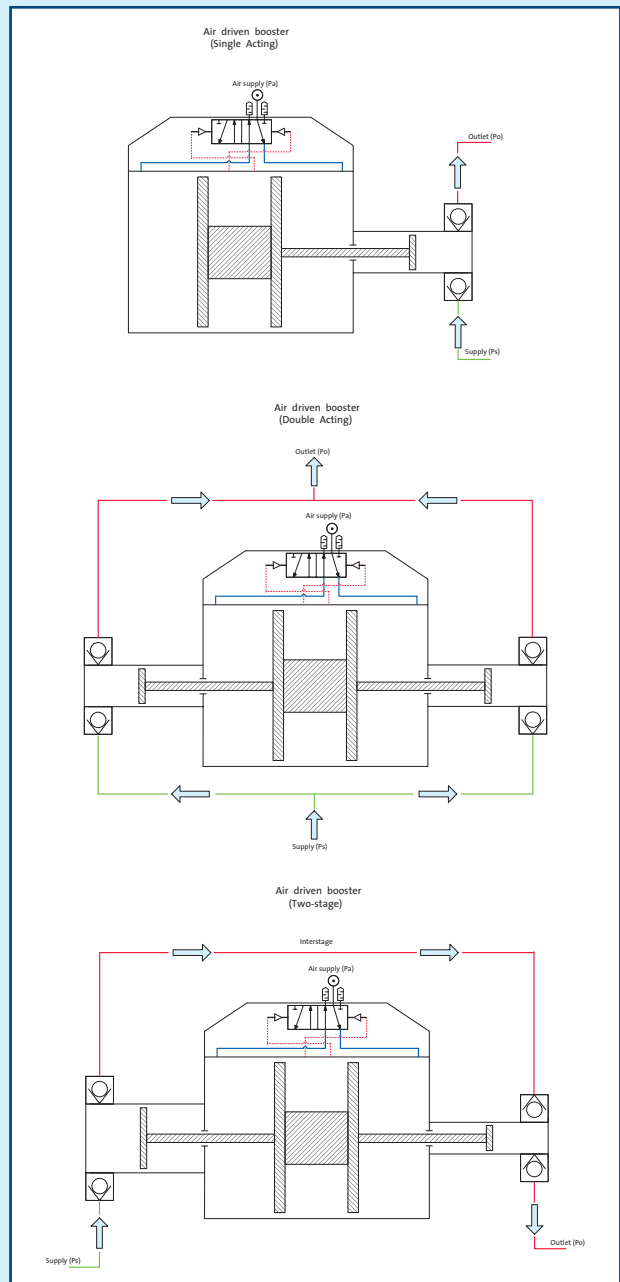

ADVANTAGES OF RESATO AIR-DRIVEN GAS BOOSTER TYPES B160 AND B200

Suitable for many types of gases because all gas contacted parts of the high-pressure section are made of special selected stainless steel and bronze.

Long working life of the seals because the gas boosters are standard provided with specially engineered polymer compounds based on low-friction PTFE resins for optimum piston sealing to accommodate use of a wide range of gases.

Check valve cartridges can be replaced within minutes. Due to the use of ceramic materials for the check valves, long life operation can be guaranteed.

Air drive of the gas booster with only the air piston and cycling spool as moving parts.

Unlike most other air-driven gas boosters, there are no mechanical pilot valves and long internal pilot channels which have a negative influence on the reliability and cycling speed of the gas booster. The air cycling valve is mounted directly on top of the air cylinder.

Low noise level compared to other air-driven gas boosters with mechanical pilot valves.

Freezing of the gas booster is avoided by using an air cycling valve provided with light weight spool for high airflow at low air velocity.

Equal cooling flow of high pressure gas cylinder by symmetric design of the booster.

The high-pressure seal can be replaced within minutes, without dismantling the air drive section. Costly downtime is reduced to a minimum.

Standard provided with vent holes to prevent gas from the high pressure gas section escaping to the air drive section.

Less frictional resistance of the air piston. Unlike other air-driven gas boosters, the air piston sealing of a Resato air-driven gas booster is not an O-ring. It is a V-shaped expanding ring, which needs less preload than an O-ring. The air piston is provided with PTFE based slydrings (bearings) for excellent wear-and-slide qualities. The slydrings increase the service life of the sealing surface (air cylinder) and the air piston sealing.

Excellent control of flow and output pressure due to low frictional resistance of the air piston, even at low air drive pressure.

History of proven reliability under severe conditions, for instance in offshore use.

All pressure and flow output is based on 7 bar (100 psi) air drive pressure instead of 10 bar (150 psi).

WHY USE AN AIR-DRIVEN GAS BOOSTER

Compressed air used as a power drive offers enormous advantages over use of other power drives: risks of excessive heat, flame, spark or shock are reduced considerably. Apart from that, both output pressure and flow can be controlled by simply regulating the air drive pressure of the air-driven gas booster. Varying the air inlet pressure will automatically and accurately adjust the output pressure. The cycling speed is at a maximum when the outlet pressure is low. As the outlet pressure builds up, the cycling speed is reduced until a stall condition is reached at the desired outlet pressure. The stall pressure can be held without any further use of energy.

Other gases such as nitrogen or CO₂ can be used as alternatives to drive the gas booster.

Resato air-driven boosters are simple to install, they are compact and very quick and easy to maintain.

OPERATING THE RESATO AIR-DRIVEN GAS BOOSTER

The outlet pressure and flow can be controlled by regulating the air drive pressure with an air pressure regulator. When compressed air of a certain air pressure is applied to the gas booster, it will cycle at high speed producing high gas flow. As the outlet pressure increases, the gas booster will start to work at a lower rate. As long as the total load in the high pressure cylinder is less than that in the air cylinder, the gas booster will continue to run. When a balance of loads is reached, the gas booster stops and no more air is used. The gas booster will automatically restart when the balance is disturbed by a outlet pressure drop or by increasing the air drive pressure. As the frictional resistance of the Resato air-driven piston is very low, only a small pressure drop or air drive pressure increase is required to restart the gas booster.

HOW TO SELECT THE RIGHT RESATO BOOSTER

Because gas is a compressible medium, the selection of a gas booster that best suits your needs is much more critical than for a liquid pump. The following parameters have to be considered to determine which gas booster to use:

- Maximum output pressure
- Gas supply pressure to the booster.
Constant or decreasing? The minimum and the maximum gas supply pressure?
- Flow rate required at a certain pressure or the required fill time of an indicated vessel volume
- Air drive pressure
- Air drive volume
- Type of gas
- External conditions like hazardous areas.

The charts in the following pages may help you in selecting the proper booster type. Make a selection on pressure first, then make a selection of the required flow rate based on the gas supply pressure. However, for an accurate gas booster selection, contact Resato. Our specially developed computer program will accurately calculate the right booster type for your application area.

Dangerous gases

For dangerous gases, Resato offers a common leak hole solution for gas boosters. In case of a leaking seal, gases are led to a single outlet for outdoor blowing or to be connected to a sniffer (code CL). On request, Resato gas boosters can be built as "oxygen clean" (code OX).

ATEX

As an option, Resato air driven gas boosters can be delivered in an ATEX 94/9/EC compliant version. The user of the gas booster is responsible for classifying the area of use, while identifying the equipment category is the responsibility of the manufacturer. Resato gas boosters are ATEX approved for Group II, category 2 zones G & D (code EX).

GAS BOOSTER SELECTION INFORMATION:

B160 - 65 - 2/EX

Diameter of the air-driven piston: 160 mm.

B160 - **65** - 2/EX

Nominal working ratio of the gas booster: 65

B160 - 65 - **2**/EX

Double acting type (single acting is indicated by 1; double stage is indicated with two ratios)

B160 - 65 - **2/EX**

Atex version (EX)

INSTALLATION

Resato gas boosters can be mounted in any position. For maintenance reasons you are advised to mount gas boosters in horizontal position, using the four thread holes in the air drive end caps. If it is not possible to use the standard thread holes, brackets can be used (see Accessories).

The gas boosters will deliver their rated capacity at 7 bar (100 psi) air drive pressure with the required air flow. The air supply line requires an air pressure regulator to control the output of the gas booster. Apart from that it is necessary to mount an oil lubricator and a filter/water separator in the air supply line.

A start/stop air valve can be mounted in the air supply line on request.

Type	Pressure ratio	Max. compression ratio	Stroke volume ratio	Stroke volume	Minimal supply pressure (Ps)	Maximum supply pressure (Ps)	Actual gas outlet pressure (Ps)	Max. outlet pressure (Ps)	Air drive pressure (Pa)	Air supply connection	Gas supply connection	Outlet connection	Weight
up to 0-30 bar													
B160-2-5-1	2.5	1:10	-	785 cc	1.8 bar (26 psi)	18 bar (260 psi)	2.5xPa	18 bar (260 psi)	1-7 bar (14-100 psi)	3/4" BSP-F	1/2" NPT-F	1/2" NPT-F	17.5 kg
B160-2-5-2	2.5	1:10	-	1570 cc	1.8 bar (26 psi)	18 bar (260 psi)	2.5xPa+Ps	18 bar (260 psi)	1-7 bar (14-100 psi)	3/4" BSP-F	1/2" NPT-F	1/2" NPT-F	22 kg
B200-2-5-2	2.5	1:10	-	2450 cc	1.8 bar (26 psi)	18 bar (260 psi)	2.5xPa+Ps	18 bar (260 psi)	1-7 bar (14-100 psi)	3/4" BSP-F	1/2" NPT-F	1/2" NPT-F	29kg
B200-4-2	4	1:10	-	1570 cc	2.8 bar (40 psi)	28 bar (405 psi)	4xPa+Ps	28 bar (405 psi)	1-7 bar (14-100 psi)	3/4" BSP-F	1/2" NPT-F	1/2" NPT-F	29 kg
up to 50 bar													
B160-5-1	5	1:15	-	385 cc	2.4 bar (35 psi)	35 bar (510 psi)	5xPa	35 bar (510 psi)	1-7 bar (14-100 psi)	3/4" BSP-F	1/2" NPT-F	1/2" NPT-F	17.5 kg
B160-5-2	5	1:15	-	770 cc	2.4 bar (35 psi)	35 bar (510 psi)	5xPa+Ps	35 bar (510 psi)	1-7 bar (14-100 psi)	3/4" BSP-F	1/2" NPT-F	1/2" NPT-F	22 kg
B160-2-5-5	1:2.5 / 1:5	1:35	1:2	785 cc	1.3 bar (19 psi)	2.5xPa	5xPa+2xPs	45 bar (650 psi)	1-7 bar (14-100 psi)	3/4" BSP-F	1/2" NPT-F	1/2" NPT-F	22 kg
B200-2-5-4	1:2.5 / 1:4	1:35	1:1.6	1225 cc	1.3 bar (19 psi)	4.2xPa	4xPa+1.6xPs	45 bar (650 psi)	1-7 bar (14-100 psi)	3/4" BSP-F	1/2" NPT-F	1/2" NPT-F	29 kg
up to 120 bar													
B200-8-2	8	1:15	-	770 cc	3.8 bar (55 psi)	55 bar (795 psi)	8xPa+Ps	55 bar (795 psi)	1-7 bar (14-100 psi)	3/4" BSP-F	1/2" NPT-F	1/2" NPT-F	29 kg
B160-10-1	10	1:15	-	200 cc	4.8 bar (70 psi)	70 bar (1015 psi)	10xPa	70 bar (1015 psi)	1-7 bar (14-100 psi)	3/4" BSP-F	1/2" NPT-F	1/2" NPT-F	17.5 kg
B160-10-2	10	1:15	-	400 cc	4.7 bar (68 psi)	70 bar (1015 psi)	10xPa+Ps	70 bar (1015 psi)	1-7 bar (14-100 psi)	3/4" BSP-F	1/2" NPT-F	1/2" NPT-F	22 kg
B160-15-2	15	1:15	-	250 cc	7.4 bar (110 psi)	110 bar (1595 psi)	15xPa+Ps	110 bar (1595 psi)	1-7 bar (14-100 psi)	3/4" BSP-F	1/4" NPT-F	1/4" NPT-F	22 kg
B200-15-2	15	1:15	-	400 cc	7.4 bar (110 psi)	110 bar (1595 psi)	15xPa+Ps	110 bar (1595 psi)	1-7 bar (14-100 psi)	3/4" BSP-F	1/2" NPT-F	1/2" NPT-F	29 kg
B160-15-1	15	1:15	-	125 cc	7.5 bar (110 psi)	115 bar (1670 psi)	15xPa	115 bar (1670 psi)	1-7 bar (14-100 psi)	3/4" BSP-F	1/4" NPT-F	1/4" NPT-F	17.5 kg
B160-5-15	1:5 / 1:15	1:50	1:3	385 cc	2.3 bar (33 psi)	2.5xPa	15xPa+3xPs	115 bar (1670 psi)	1-7 bar (14-100 psi)	3/4" BSP-F	1/2" NPT-F	1/4" NPT-F	22 kg
B200-4-15	1:4 / 1:15	1:60	1:3.8	785 cc	1.9 bar (30 psi)	4xPa	15xPa+3.8xPs	115 bar (1670 psi)	1-7 bar (14-100 psi)	3/4" BSP-F	1/2" NPT-F	1/2" NPT-F	29 kg
up to 250 bar													
B200-25-2	25	1:15	-	250 cc	11.6 bar (170 psi)	175 bar (2540 psi)	25xPa+Ps	175 bar (2540 psi)	1-7 bar (14-100 psi)	3/4" BSP-F	1/4" NPT-F	1/4" NPT-F	29 kg
B160-30-1	30	1:15	-	70 cc	13.3 bar (190 psi)	210 bar (3050 psi)	30xPa	210 bar (3050 psi)	1-7 bar (14-100 psi)	3/4" BSP-F	1/4" NPT-F	1/4" NPT-F	17.5 kg
B160-30-2	30	1:15	-	140 cc	13.2 bar (190 psi)	210 bar (3050 psi)	30xPa+Ps	210 bar (3050 psi)	1-7 bar (14-100 psi)	3/4" BSP-F	1/4" NPT-F	1/4" NPT-F	22 kg
B160-5-30	1:5 / 1:30	1:100	1:6	385 cc	2.0 bar (30 psi)	1xPa	30xPa+6xPs	210 bar (3050 psi)	1-7 bar (14-100 psi)	3/4" BSP-F	1/2" NPT-F	1/4" NPT-F	22 kg
B160-15-30	1:15 / 1:30	1:30	1:2	125 cc	8.3 bar (120 psi)	15xPa	30xPa+2xPs	250 bar (3625 psi)	1-7 bar (14-100 psi)	3/4" BSP-F	1/4" NPT-F	1/4" NPT-F	22 kg
up to 350 bar													
B160-40-1	40	1:15	-	50 cc	19.1 bar (275 psi)	285 bar (4130 psi)	40xPa	285 bar (4130 psi)	1-7 bar (14-100 psi)	3/4" BSP-F	M16x1.5 HP-F	M16x1.5 HP-F	17.5 kg
B160-40-2	40	1:15	-	100 cc	18.9 bar (275 psi)	285 bar (4130 psi)	40xPa+Ps	285 bar (4130 psi)	1-7 bar (14-100 psi)	3/4" BSP-F	M16x1.5 HP-F	M16x1.5 HP-F	22 kg
B200-45-2	45	1:15	-	140 cc	20.6 bar (300 psi)	310 bar (4495 psi)	45xPa+Ps	310 bar (4495 psi)	1-7 bar (14-100 psi)	3/4" BSP-F	1/4" NPT-F	1/4" NPT-F	29 kg
B200-15-45	1:15 / 1:45	1:40	1:3	200 cc	8.1 bar (115 psi)	7.5xPa	45xPa+3xPs	325 bar (4715 psi)	1-7 bar (14-100 psi)	3/4" BSP-F	1/2" NPT-F	1/4" NPT-F	29 kg
up to 500 bar													
B160-65-2	65	1:15	-	60 cc	29.6 bar (430 psi)	450 bar (6525 psi)	65xPa+Ps	450 bar (6525 psi)	1-7 bar (14-100 psi)	3/4" BSP-F	M16x1.5 HP-F	M16x1.5 HP-F	22 kg
B200-65-2	65	1:15	-	100 cc	29.7 bar (430 psi)	450 bar (6525 psi)	65xPa+Ps	450 bar (6525 psi)	1-7 bar (14-100 psi)	3/4" BSP-F	M16x1.5 HP-F	M16x1.5 HP-F	29 kg
B160-65-1	65	1:15	-	30 cc	29.9 bar (435 psi)	450 bar (6525 psi)	65xPa	450 bar (6525 psi)	1-7 bar (14-100 psi)	3/4" BSP-F	M16x1.5 HP-F	M16x1.5 HP-F	17.5 kg
B160-15-65	1:15 / 1:65	1:60	1:4	125 cc	7.5 bar (110 psi)	4.5xPa	65xPa+4xPs	450 bar (6525 psi)	1-7 bar (14-100 psi)	3/4" BSP-F	1/4" NPT-F	M16x1.5 HP-F	22 kg
B200-15-65	1:15 / 1:65	1:55	1:4.3	200 cc	8.2 bar (120 psi)	4.5xPa	65xPa+4.3xPs	450 bar (6525 psi)	1-7 bar (14-100 psi)	3/4" BSP-F	1/2" NPT-F	M16x1.5 HP-F	29 kg
B200-25-65	1:25 / 1:65	1:40	1:2.6	125 cc	12.2 bar (175 psi)	15.6xPa	65xPa+2.6xPs	485 bar (7030 psi)	1-7 bar (14-100 psi)	3/4" BSP-F	1/4" NPT-F	M16x1.5 HP-F	29 kg
up to 800 bar													
B160-30-65	1:30 / 1:65	1:30	1:2	70 cc	17.8 bar (260 psi)	25.5xPa	65xPa+2xPs	535 bar (7760 psi)	1-7 bar (14-100 psi)	3/4" BSP-F	1/4" NPT-F	M16x1.5 HP-F	22 kg
B200-100-2	100	1:15	-	60 cc	46.4 bar (670 psi)	695 bar (10080 psi)	100xPa+Ps	695 bar (10080 psi)	1-7 bar (14-100 psi)	3/4" BSP-F	M16x1.5 HP-F	M16x1.5 HP-F	29 kg
B200-25-100	1:25 / 1:100	1:60	1:4	125 cc	11.8 bar (170 psi)	8.3xPa	100xPa+4xPs	710 bar (10295 psi)	1-7 bar (14-100 psi)	3/4" BSP-F	1/4" NPT-F	M16x1.5 HP-F	29 kg
B200-45-100	1:45 / 1:100	1:60	1:2.3	70 cc	2.3 bar (33 psi)	34xPa	100xPa+2.3xPs	725 bar (10295 psi)	1-7 bar (14-100 psi)	3/4" BSP-F	1/4" NPT-F	M16x1.5 HP-F	29 kg
B160-115-2	115	1:15	-	36 cc	52.6 bar (760 psi)	790 bar (11455 psi)	115xPa+Ps	800 bar (11600 psi)	1-7 bar (14-100 psi)	3/4" BSP-F	M16x1.5 HP-F	M16x1.5 HP-F	22 kg
B160-115-1	115	1:15	-	18 cc	53.1 bar (770 psi)	800 bar (11600 psi)	115xPa	800 bar (11600 psi)	1-7 bar (14-100 psi)	3/4" BSP-F	M16x1.5 HP-F	M16x1.5 HP-F	17.5 kg
B160-30-115	1:30 / 1:115	1:50	1:4	70 cc	16.1 bar (230 psi)	10.5xPa	115xPa+4xPs	805 bar (11670 psi)	1-7 bar (14-100 psi)	3/4" BSP-F	1/4" NPT-F	M16x1.5 HP-F	22 kg
up to 1350 bar													
B160-180-2	180	1:15	-	22.6 cc	82.2 bar (1190 psi)	1235 bar (17910 psi)	180xPa+Ps	1260 bar (18270 psi)	1-7 bar (14-100 psi)	3/4" BSP-F	M16x1.5 HP-F	M16x1.5 HP-F	22 kg
B200-180-2	180	1:15	-	36 cc	82.5 bar (1195 psi)	1235 bar (17910 psi)	180xPa+Ps	1260 bar (18270 psi)	1-7 bar (14-100 psi)	3/4" BSP-F	M16x1.5 HP-F	M16x1.5 HP-F	29 kg
B160-180-1	180	1:15	-	11.3 cc	83 bar (1200 psi)	1245 bar (17910 psi)	180xPa	1260 bar (18270 psi)	1-7 bar (14-100 psi)	3/4" BSP-F	M16x1.5 HP-F	M16x1.5 HP-F	17.5 kg
B160-30-180	1:30 / 1:180	1:80	1:6	70 cc	15.6 bar (225 psi)	6xPa	180xPa+6xPs	1330 bar (19285 psi)	1-7 bar (14-100 psi)	3/4" BSP-F	1/4" NPT-F	M16x1.5 HP-F	22 kg
B160-65-180	1:65 / 1:180	1:40	1:3	30 cc	33.3 bar (480 psi)	36xPa	180xPa+3xPs	1330 bar (19285 psi)	1-7 bar (14-100 psi)	3/4" BSP-F	M16x1.5 HP-F	M16x1.5 HP-F	22 kg
B200-65-180	1:65 / 1:180	1:60	1:2.8	50 cc	22.2 bar (320 psi)	36.7xPa	180xPa+2.8xPs	1330 bar (19285 psi)	1-7 bar (14-100 psi)	3/4" BSP-F	M16x1.5 HP-F	M16x1.5 HP-F	29 kg

GAS BOOSTER TYPE TABLE

BOOSTERS FOR PRESSURE UP TO 30 BAR

B160-2,5-1

QA = Air flow
 Pa = Air drive pressure
 Ps = Supply pressure
 Po = Outlet pressure

TECHNICAL DATA	B160-2,5-1
Pressure ratio	1:2,5
Max. compression ratio	1:10
Stroke volume ratio	-
Stroke volume	785 cc
Minimal supply pressure (Ps)	1,8 bar (26 psi)
Maximum supply pressure (Ps)	18 bar (260 psi)
Actual gas outlet pressure (Po)	2,5 x Pa
Max. outlet pressure (Po)	18 bar (260 psi)
Air drive pressure (Pa)	1-7 bar (14-100 psi)
Air supply connection	3/4" BSP-F
Gas supply connection	1/2" NPT-F
Outlet connection	1/2" NPT-F
Weight	17,5 kg

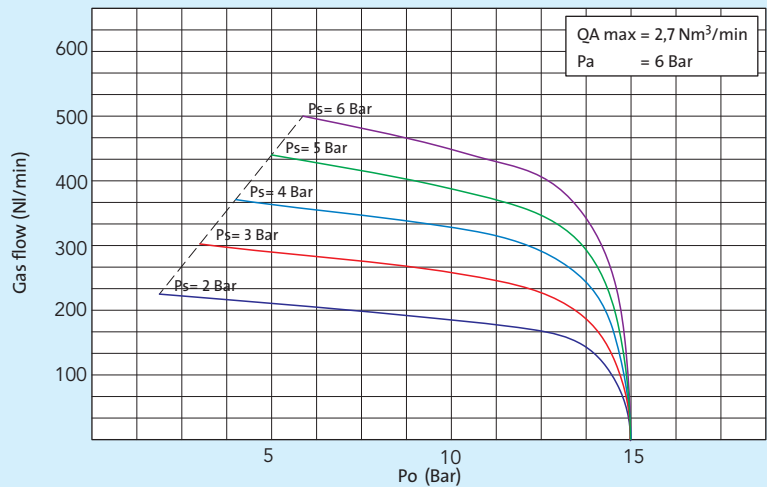
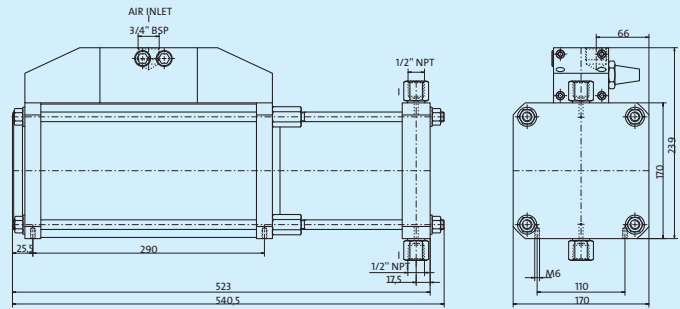

B160-2,5-2

QA = Air flow
 Pa = Air drive pressure
 Ps = Supply pressure
 Po = Outlet pressure

TECHNICAL DATA	B160-2,5-2
Pressure ratio	1:2,5
Max. compression ratio	1:10
Stroke volume ratio	-
Stroke volume	1570 cc
Minimal supply pressure (Ps)	1,8 bar (26 psi)
Maximum supply pressure (Ps)	18 bar (260 psi)
Actual gas outlet pressure (Po)	2,5 x Pa + Ps
Max. outlet pressure (Po)	18 bar (260 psi)
Air drive pressure (Pa)	1-7 bar (14-100 psi)
Air supply connection	3/4" BSP-F
Gas supply connection	1/2" NPT-F
Outlet connection	1/2" NPT-F
Weight	22 kg

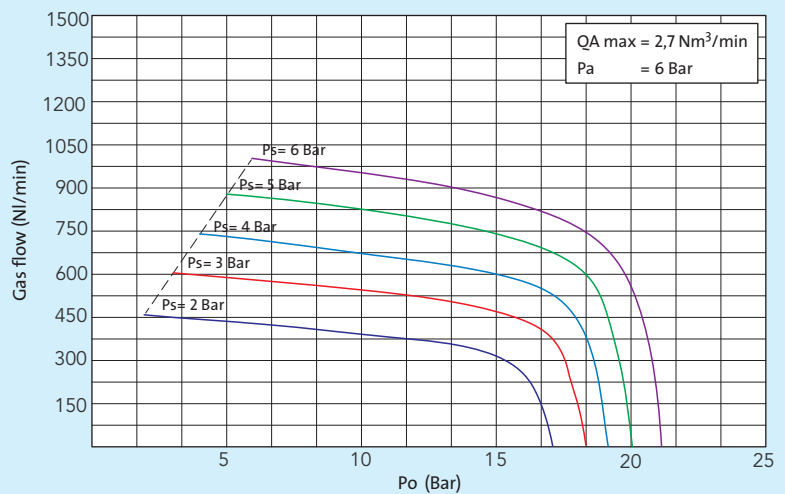
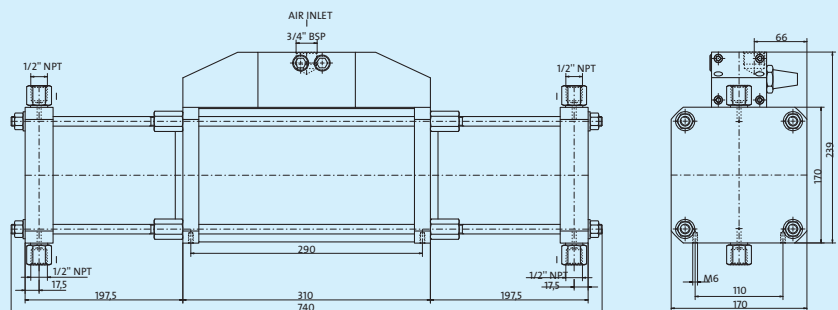

BOOSTERS FOR PRESSURE UP TO 30 BAR

B200-2,5-2

QA = Air flow
 Pa = Air drive pressure
 Ps = Supply pressure
 Po = Outlet pressure

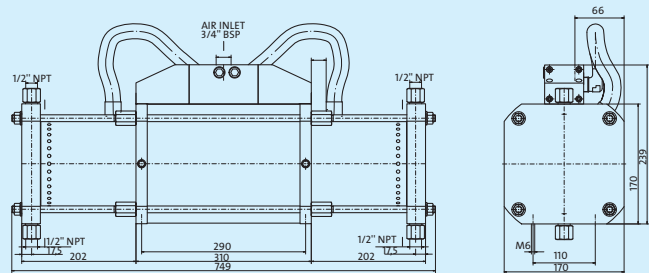

TECHNICAL DATA	B200-2,5-2
Pressure ratio	1:2,5
Max. compression ratio	1:10
Stroke volume ratio	-
Stroke volume	2450 cc
Minimal supply pressure (Ps)	1,8 bar (26 psi)
Maximum supply pressure (Ps)	18 bar (260 psi)
Actual gas outlet pressure (Po)	$2,5 \times Pa + Ps$
Max. outlet pressure (Po)	18 bar (260 psi)
Air drive pressure (Pa)	1-7 bar (14-100 psi)
Air supply connection	3/4" BSP-F
Gas supply connection	1/2" NPT-F
Outlet connection	1/2" NPT-F
Weight	29 kg

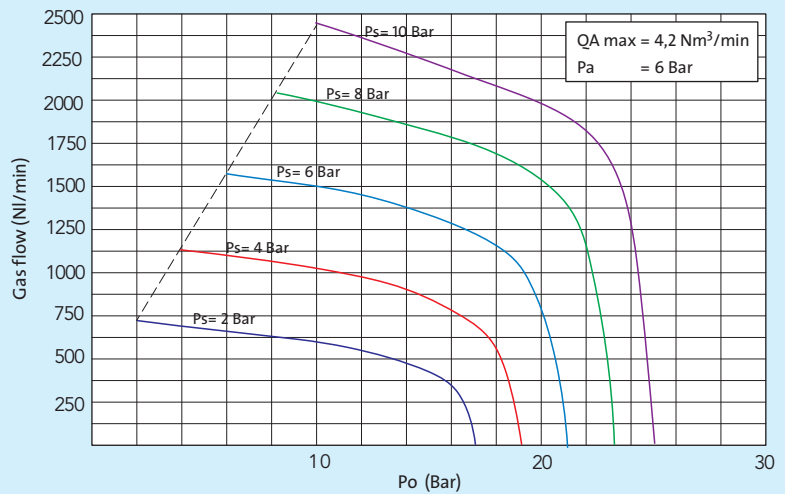

B200-4-2

QA = Air flow
 Pa = Air drive pressure
 Ps = Supply pressure
 Po = Outlet pressure

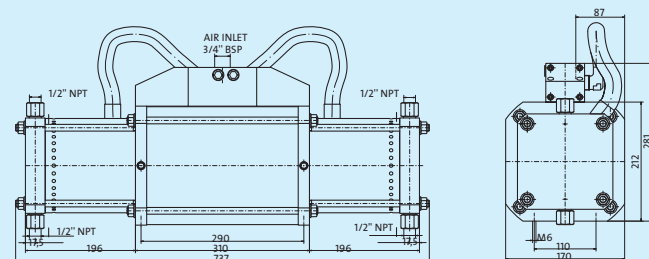

TECHNICAL DATA	B200-4-2
Pressure ratio	1:4
Max. compression ratio	1:10
Stroke volume ratio	-
Stroke volume	1570 cc
Minimal supply pressure (Ps)	2,8 bar (40 psi)
Maximum supply pressure (Ps)	28 bar (405 psi)
Actual gas outlet pressure (Po)	$4 \times Pa + Ps$
Max. outlet pressure (Po)	28 bar (405 psi)
Air drive pressure (Pa)	1-7 bar (14-100 psi)
Air supply connection	3/4" BSP-F
Gas supply connection	1/2" NPT-F
Outlet connection	1/2" NPT-F
Weight	29 kg

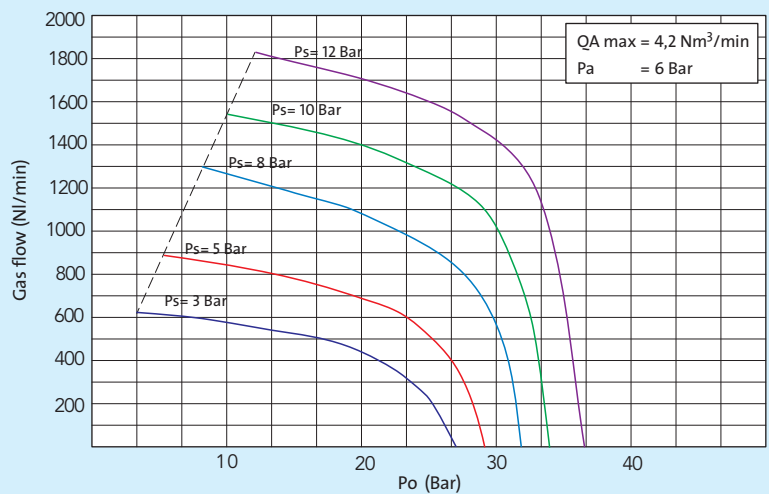

BOOSTERS FOR PRESSURE UP TO 50 BAR

B160-5-1

QA = Air flow
 Pa = Air drive pressure
 Ps = Supply pressure
 Po = Outlet pressure

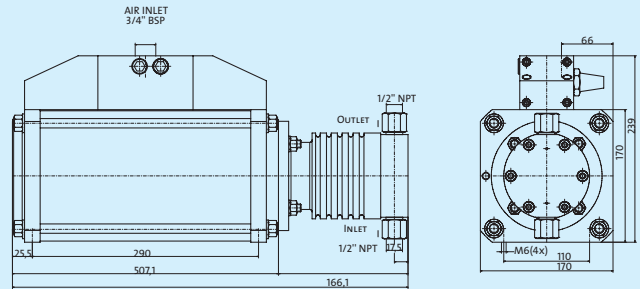

TECHNICAL DATA	B160-5-1
Pressure ratio	1:5
Max. compression ratio	1:15
Stroke volume ratio	-
Stroke volume	385 cc
Minimal supply pressure (Ps)	2,4 bar (35 psi)
Maximum supply pressure (Ps)	35 bar (510 psi)
Actual gas outlet pressure (Po)	5 x Pa
Max. outlet pressure (Po)	35 bar (510 psi)
Air drive pressure (Pa)	1-7 bar (14-100 psi)
Air supply connection	3/4" BSP-F
Gas supply connection	1/2" NPT-F
Outlet connection	1/2" NPT-F
Weight	17,5 kg

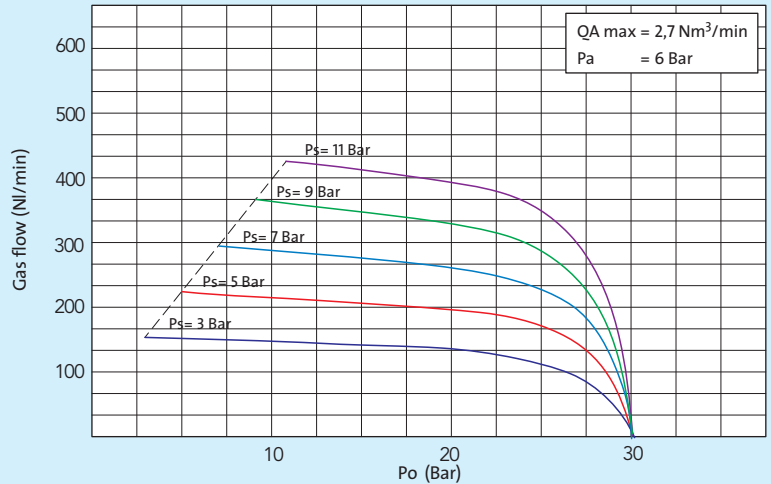

B160-5-2

QA = Air flow
 Pa = Air drive pressure
 Ps = Supply pressure
 Po = Outlet pressure

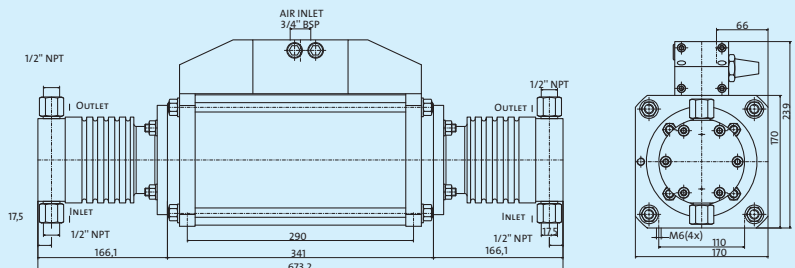

TECHNICAL DATA	B160-5-2
Pressure ratio	1:5
Max. compression ratio	1:15
Stroke volume ratio	-
Stroke volume	770 cc
Minimal supply pressure (Ps)	2,4 bar (35 psi)
Maximum supply pressure (Ps)	35 bar (510 psi)
Actual gas outlet pressure (Po)	5 x Pa + Ps
Max. outlet pressure (Po)	35 bar (510 psi)
Air drive pressure (Pa)	1-7 bar (14-100 psi)
Air supply connection	3/4" BSP-F
Gas supply connection	1/2" NPT-F
Outlet connection	1/2" NPT-F
Weight	22 kg

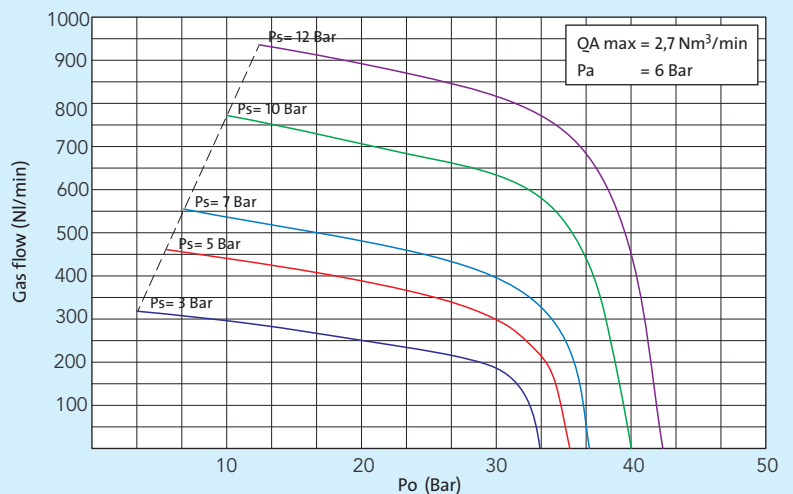

BOOSTERS FOR PRESSURE UP TO 50 BAR

B160-2,5-5

QA = Air flow
 Pa = Air drive pressure
 Ps = Supply pressure
 Po = Outlet pressure

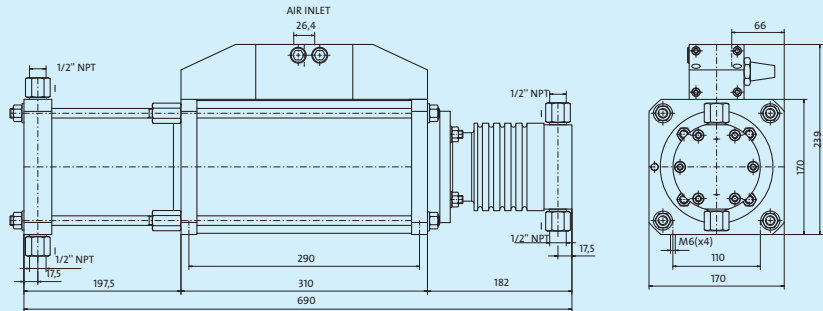

TECHNICAL DATA	B160-2,5-5
Pressure ratio	1:2,5/1:5
Max. compression ratio	1:35
Stroke volume ratio	1:2
Stroke volume	785 cc
Minimal supply pressure (Ps)	1,3 bar (19 psi)
Maximum supply pressure (Ps)	2,5 x Pa
Actual gas outlet pressure (Po)	5 x Pa + 2 x Ps
Max. outlet pressure (Po)	49 bar (650 psi)
Air drive pressure (Pa)	1-7 bar (14-100 psi)
Air supply connection	3/4" BSP-F
Gas supply connection	1/2" NPT-F
Outlet connection	1/2" NPT-F
Weight	22 kg

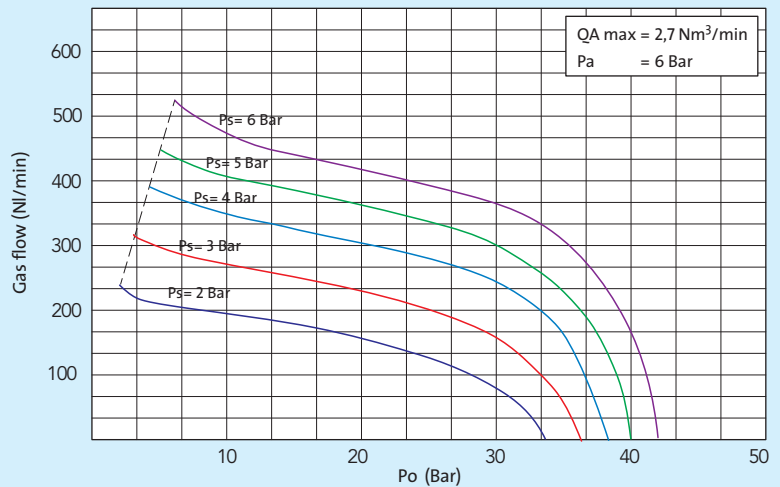

B200-2,5-4

QA = Air flow
 Pa = Air drive pressure
 Ps = Supply pressure
 Po = Outlet pressure

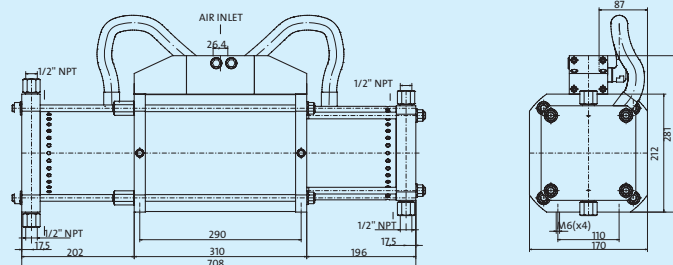

TECHNICAL DATA	B200-2,5-4
Pressure ratio	1:2,5/1:4
Max. compression ratio	1:35
Stroke volume ratio	1:1,6
Stroke volume	1225 cc
Minimal supply pressure (Ps)	1,3 bar (19 psi)
Maximum supply pressure (Ps)	4,2 x Pa
Actual gas outlet pressure (Po)	4 x Pa + 1,6 x Ps
Max. outlet pressure (Po)	45 bar (650 psi)
Air drive pressure (Pa)	1-7 bar (14-100 psi)
Air supply connection	3/4" BSP-F
Gas supply connection	1/2" NPT-F
Outlet connection	1/2" NPT-F
Weight	29 kg

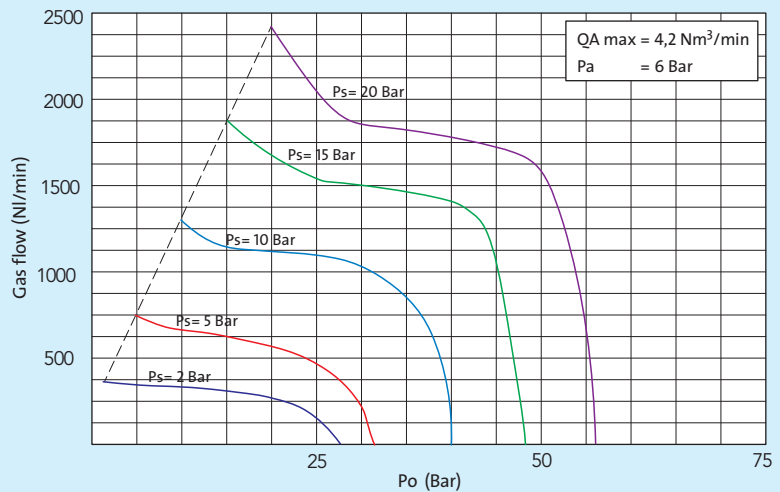

BOOSTERS FOR PRESSURE UP TO 120 BAR

B200-8-2

QA = Air flow
 Pa = Air drive pressure
 Ps = Supply pressure
 Po = Outlet pressure

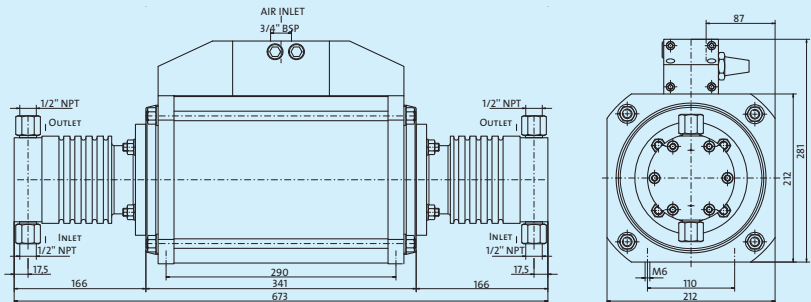

TECHNICAL DATA	B200-8-2
Pressure ratio	1:8
Max. compression ratio	1:15
Stroke volume ratio	-
Stroke volume	770 cc
Minimal supply pressure (Ps)	3,8 bar (55 psi)
Maximum supply pressure (Ps)	55 bar (795 psi)
Actual gas outlet pressure (Po)	8 x Pa + Ps
Max. outlet pressure (Po)	55 bar (795 psi)
Air drive pressure (Pa)	1-7 bar (14-100 psi)
Air supply connection	3/4" BSP-F
Gas supply connection	1/2" NPT-F
Outlet connection	1/2" NPT-F
Weight	29 kg

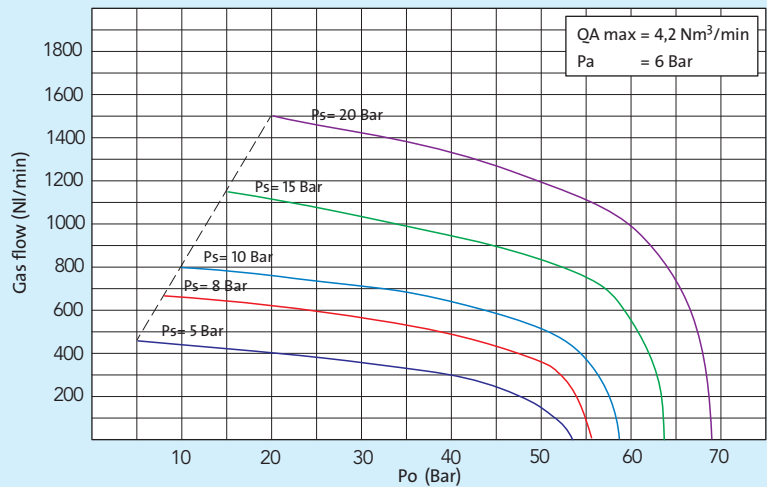

B160-10-1

QA = Air flow
 Pa = Air drive pressure
 Ps = Supply pressure
 Po = Outlet pressure

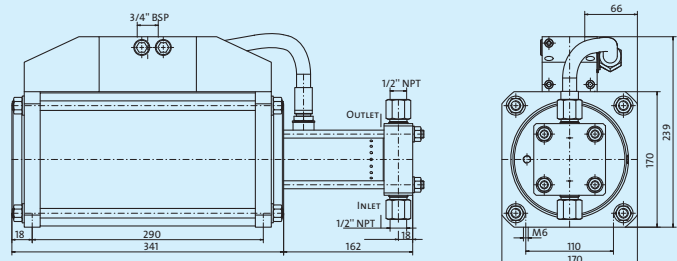

TECHNICAL DATA	B160-10-1
Pressure ratio	1:10
Max. compression ratio	1:15
Stroke volume ratio	-
Stroke volume	200 cc
Minimal supply pressure (Ps)	4,8 bar (70 psi)
Maximum supply pressure (Ps)	70 bar (1015 psi)
Actual gas outlet pressure (Po)	10 x Pa
Max. outlet pressure (Po)	70 bar (1015 psi)
Air drive pressure (Pa)	1-7 bar (14-100 psi)
Air supply connection	3/4" BSP-F
Gas supply connection	1/2" NPT-F
Outlet connection	1/2" NPT-F
Weight	17,5 kg

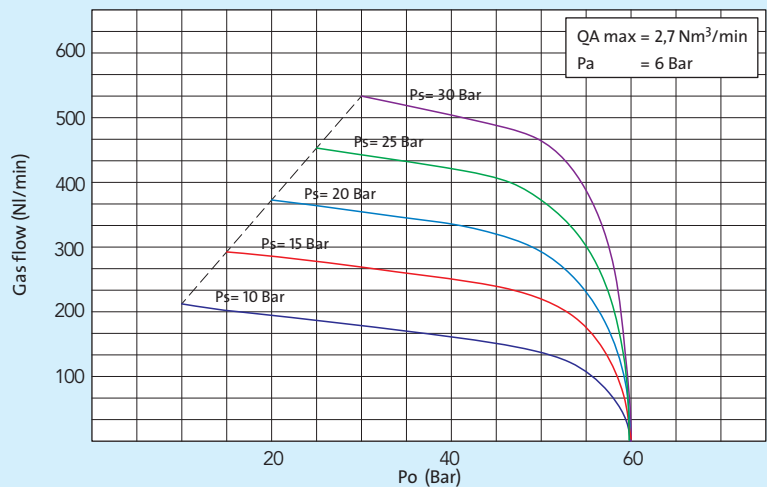

BOOSTERS FOR PRESSURE UP TO 120 BAR

B160-10-2

QA = Air flow
 Pa = Air drive pressure
 Ps = Supply pressure
 Po = Outlet pressure

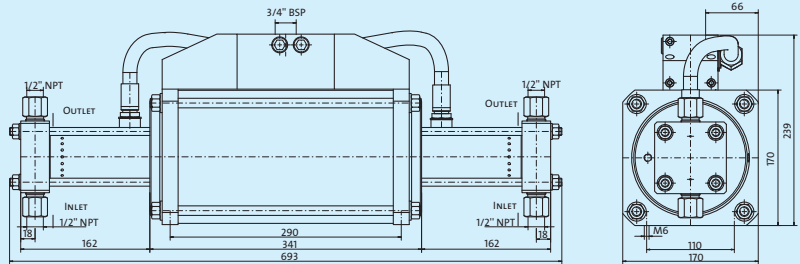

TECHNICAL DATA	B160-10-2
Pressure ratio	1:10
Max. compression ratio	1:15
Stroke volume ratio	-
Stroke volume	400 cc
Minimal supply pressure (Ps)	4,7 bar (68 psi)
Maximum supply pressure (Ps)	70 bar (1015 psi)
Actual gas outlet pressure (Po)	10 x Pa + Ps
Max. outlet pressure (Po)	70 bar (1015 psi)
Air drive pressure (Pa)	1-7 bar (14-100 psi)
Air supply connection	3/4" BSP-F
Gas supply connection	1/2" NPT-F
Outlet connection	1/2" NPT-F
Weight	22 kg

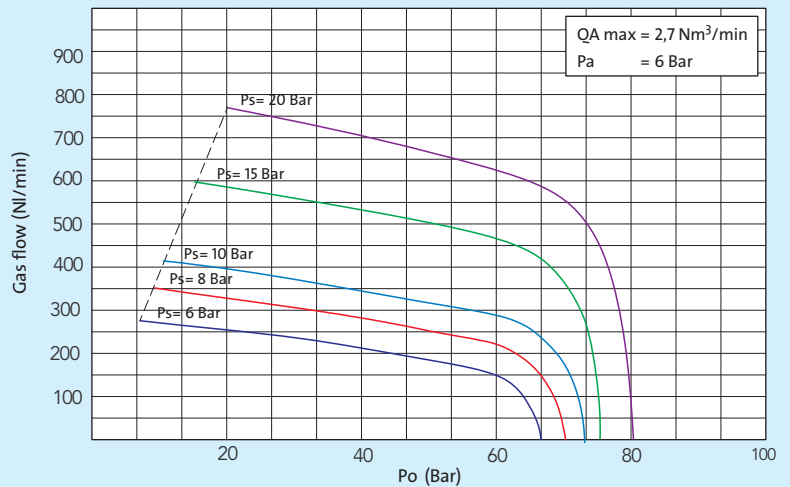

B160-15-2

QA = Air flow
 Pa = Air drive pressure
 Ps = Supply pressure
 Po = Outlet pressure

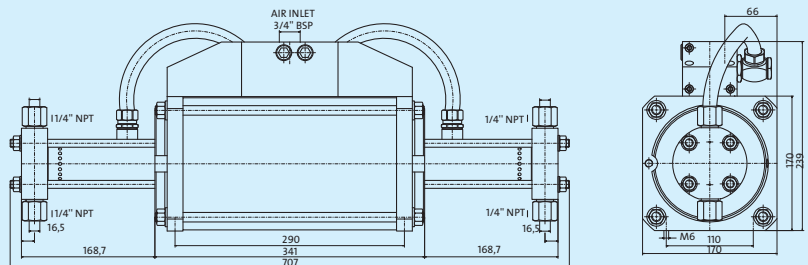

TECHNICAL DATA	B160-15-2
Pressure ratio	1:15
Max. compression ratio	1:15
Stroke volume ratio	-
Stroke volume	250 cc
Minimal supply pressure (Ps)	7,4 bar (110 psi)
Maximum supply pressure (Ps)	110 bar (1595 psi)
Actual gas outlet pressure (Po)	15 x Pa + Ps
Max. outlet pressure (Po)	110 bar (1595 psi)
Air drive pressure (Pa)	1-7 bar (14-100 psi)
Air supply connection	3/4" BSP-F
Gas supply connection	1/4" NPT-F
Outlet connection	1/4" NPT-F
Weight	22 kg

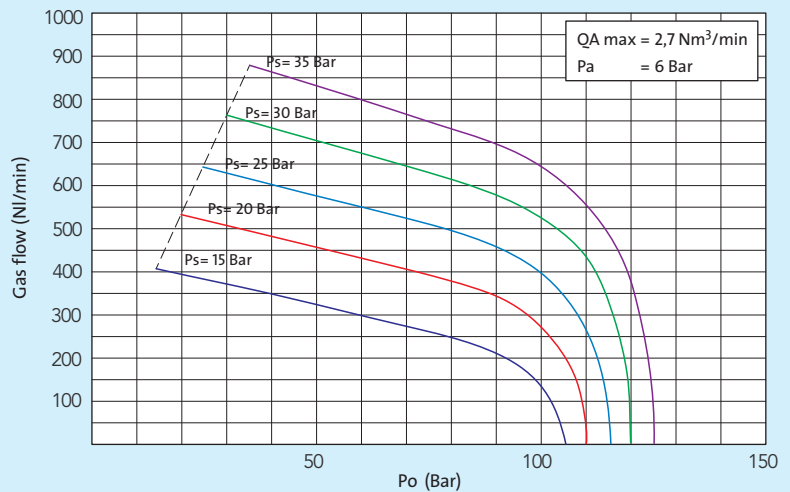

BOOSTERS FOR PRESSURE UP TO 120 BAR

B200-15-2

QA = Air flow
 Pa = Air drive pressure
 Ps = Supply pressure
 Po = Outlet pressure

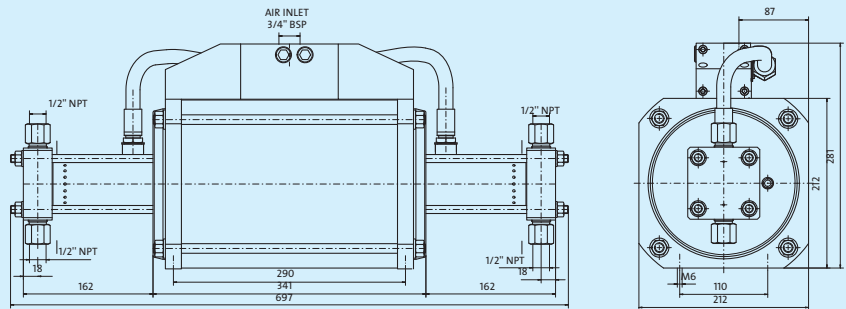

TECHNICAL DATA	B200-15-2
Pressure ratio	1:15
Max. compression ratio	1:15
Stroke volume ratio	-
Stroke volume	400 cc
Minimal supply pressure (Ps)	7,4 bar (110 psi)
Maximum supply pressure (Ps)	110 bar (1595 psi)
Actual gas outlet pressure (Po)	15 x Pa + Ps
Max. outlet pressure (Po)	110 bar (1595 psi)
Air drive pressure (Pa)	1-7 bar (14-100 psi)
Air supply connection	3/4" BSP-F
Gas supply connection	1/2" NPT-F
Outlet connection	1/2" NPT-F
Weight	29 kg

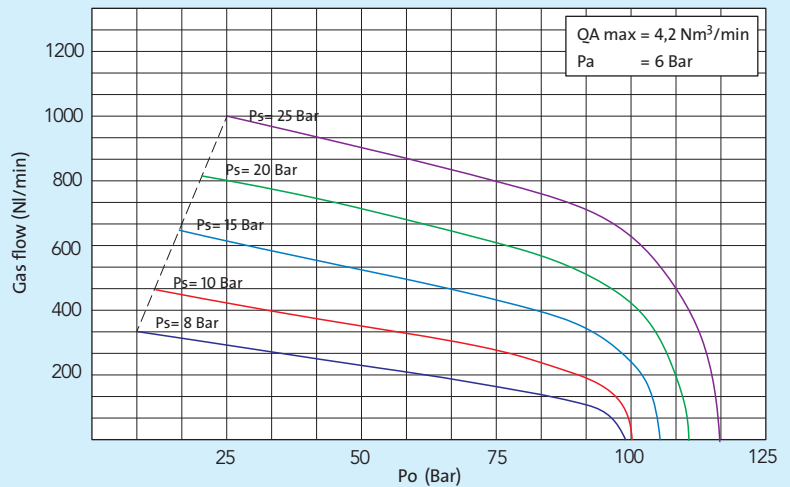

B160-15-1

QA = Air flow
 Pa = Air drive pressure
 Ps = Supply pressure
 Po = Outlet pressure

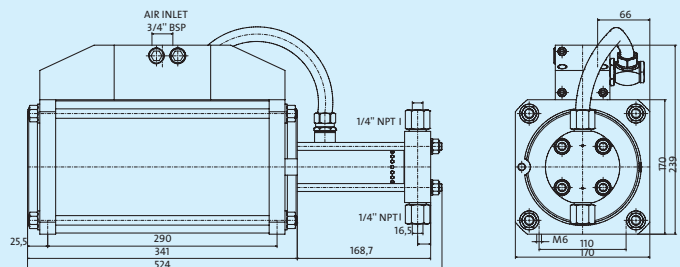

TECHNICAL DATA	B160-15-1
Pressure ratio	1:15
Max. compression ratio	1:15
Stroke volume ratio	-
Stroke volume	125 cc
Minimal supply pressure (Ps)	7,5 bar (110 psi)
Maximum supply pressure (Ps)	115 bar (1670 psi)
Actual gas outlet pressure (Po)	15 x Pa
Max. outlet pressure (Po)	115 bar (1670 psi)
Air drive pressure (Pa)	1-7 bar (14-100 psi)
Air supply connection	3/4" BSP-F
Gas supply connection	1/4" NPT-F
Outlet connection	1/4" NPT-F
Weight	17,5 kg

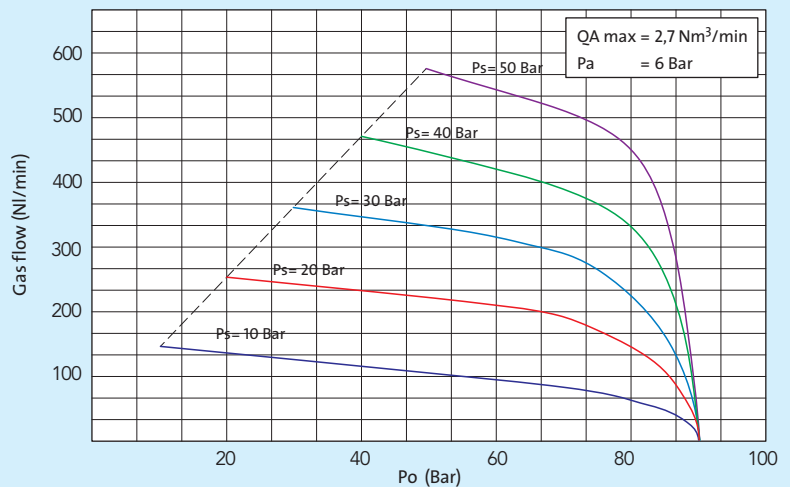

BOOSTERS FOR PRESSURE UP TO 120 BAR

B160-5-15

QA = Air flow
 Pa = Air drive pressure
 Ps = Supply pressure
 Po = Outlet pressure

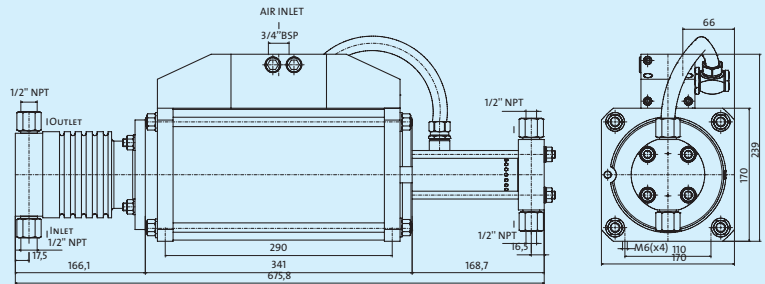

TECHNICAL DATA	B160-5-15
Pressure ratio	1:5/1:15
Max. compression ratio	1:50
Stroke volume ratio	1:3
Stroke volume	385 cc
Minimal supply pressure (Ps)	2,3 bar (33 psi)
Maximum supply pressure (Ps)	2,5 x Pa
Actual gas outlet pressure (Po)	15 x Pa + 3 x Ps
Max. outlet pressure (Po)	115 bar (1670 psi)
Air drive pressure (Pa)	1-7 bar (14-100 psi)
Air supply connection	3/4" BSP-F
Gas supply connection	1/2" NPT-F
Outlet connection	1/2" NPT-F
Weight	22 kg

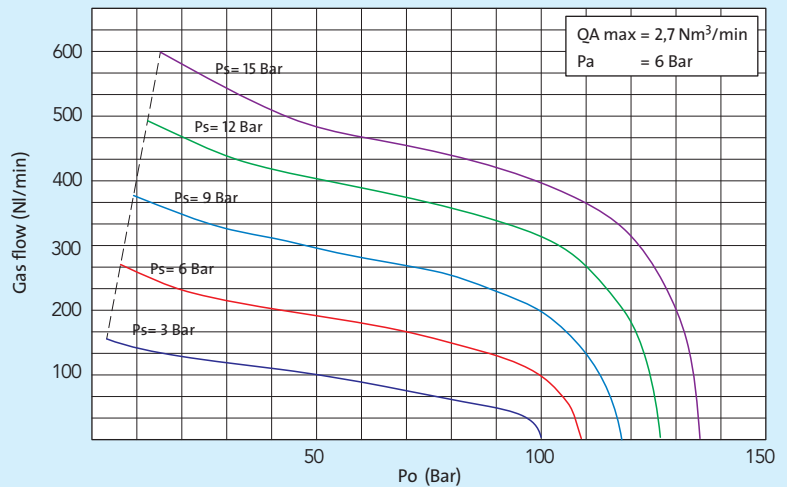

B200-4-15

QA = Air flow
 Pa = Air drive pressure
 Ps = Supply pressure
 Po = Outlet pressure

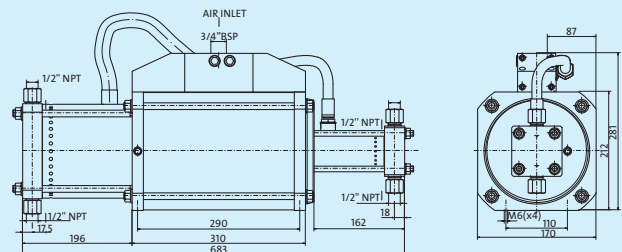

TECHNICAL DATA	B200-4-15
Pressure ratio	1:4/1:15
Max. compression ratio	1:60
Stroke volume ratio	1:3,8
Stroke volume	785 cc
Minimal supply pressure (Ps)	1,9 bar (30 psi)
Maximum supply pressure (Ps)	4 x Pa
Actual gas outlet pressure (Po)	15 x Pa + 3,8 x Ps
Max. outlet pressure (Po)	115 bar (1670 psi)
Air drive pressure (Pa)	1-7 bar (14-100 psi)
Air supply connection	3/4" BSP-F
Gas supply connection	1/2" NPT-F
Outlet connection	1/2" NPT-F
Weight	29 kg

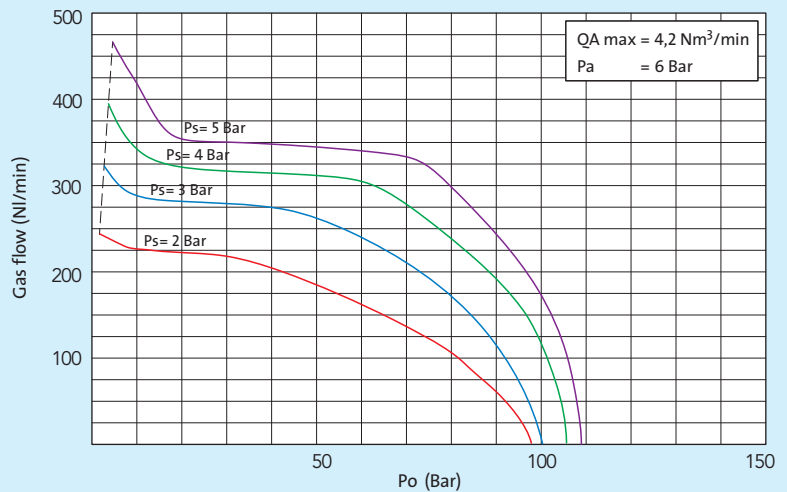

BOOSTERS FOR PRESSURE UP TO 250 BAR

B200-25-2

QA = Air flow
 Pa = Air drive pressure
 Ps = Supply pressure
 Po = Outlet pressure

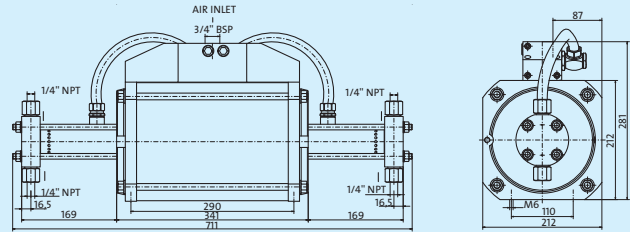

TECHNICAL DATA	B200-25-2
Pressure ratio	1:25
Max. compression ratio	1:15
Stroke volume ratio	-
Stroke volume	250 cc
Minimal supply pressure (Ps)	11,6 bar (170 psi)
Maximum supply pressure (Ps)	175 bar (2540 psi)
Actual gas outlet pressure (Po)	25 x Pa + Ps
Max. outlet pressure (Po)	175 bar (2540 psi)
Air drive pressure (Pa)	1-7 bar (14-100 psi)
Air supply connection	3/4" BSP-F
Gas supply connection	1/4" NPT-F
Outlet connection	1/4" NPT-F
Weight	29 kg

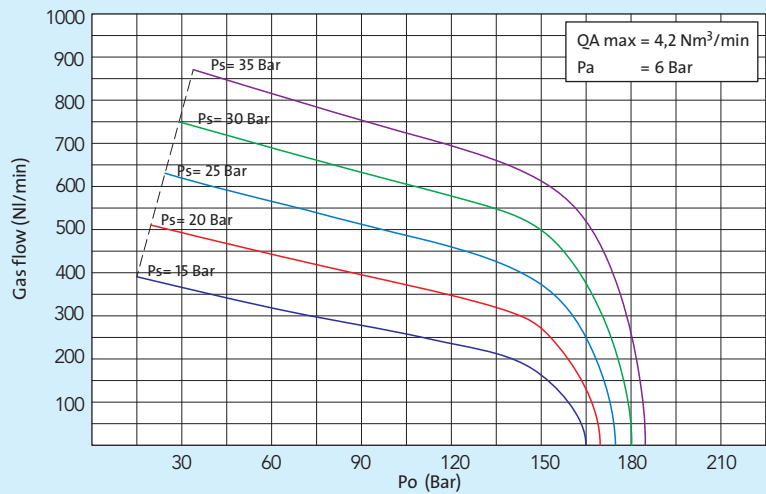

B160-30-1

QA = Air flow
 Pa = Air drive pressure
 Ps = Supply pressure
 Po = Outlet pressure

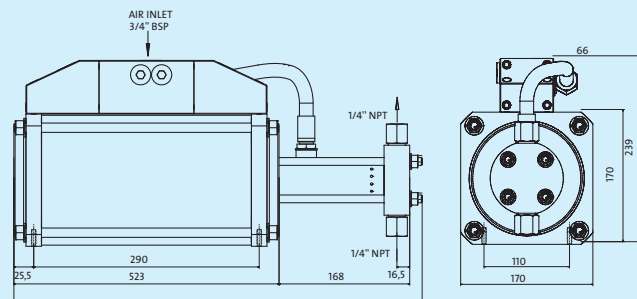

TECHNICAL DATA	B160-30-1
Pressure ratio	1:30
Max. compression ratio	1:15
Stroke volume ratio	-
Stroke volume	70 cc
Minimal supply pressure (Ps)	13,3 bar (190 psi)
Maximum supply pressure (Ps)	210 bar (3050 psi)
Actual gas outlet pressure (Po)	30 x Pa
Max. outlet pressure (Po)	210 bar (3050 psi)
Air drive pressure (Pa)	1-7 bar (14-100 psi)
Air supply connection	3/4" BSP-F
Gas supply connection	1/4" NPT-F
Outlet connection	1/4" NPT-F
Weight	17,5 kg

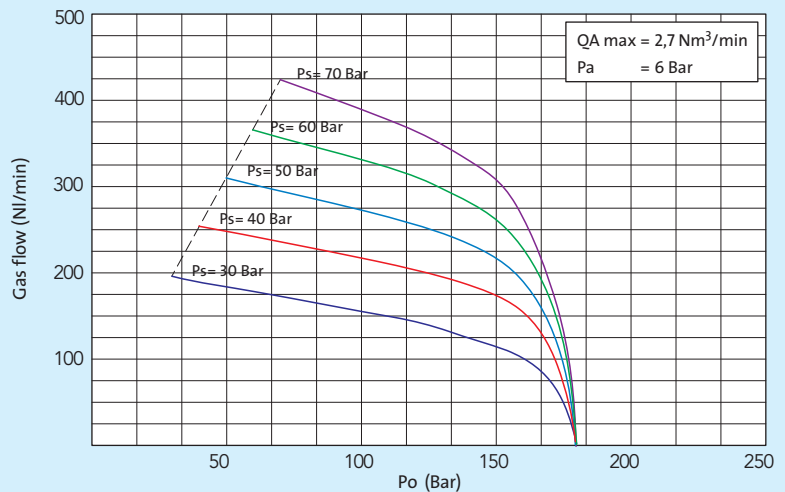

BOOSTERS FOR PRESSURE UP TO 250 BAR

B160-30-2

QA = Air flow
 Pa = Air drive pressure
 Ps = Supply pressure
 Po = Outlet pressure

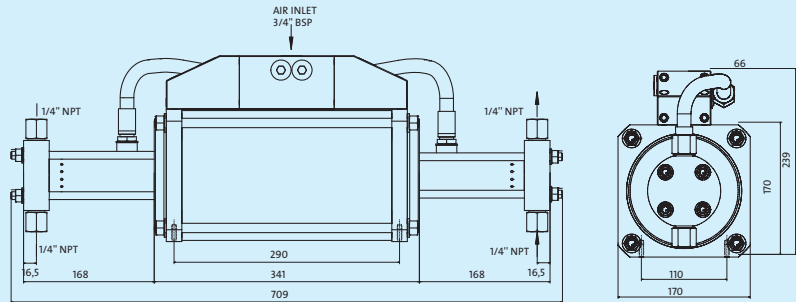

TECHNICAL DATA	B160-30-2
Pressure ratio	1:30
Max. compression ratio	1:15
Stroke volume ratio	-
Stroke volume	140 cc
Minimal supply pressure (Ps)	13,2 bar (190 psi)
Maximum supply pressure (Ps)	210 bar (3050 psi)
Actual gas outlet pressure (Po)	30 x Pa + Ps
Max. outlet pressure (Po)	210 bar (3050 psi)
Air drive pressure (Pa)	1-7 bar (14-100 psi)
Air supply connection	3/4" BSP-F
Gas supply connection	1/4" NPT-F
Outlet connection	1/4" NPT-F
Weight	22 kg

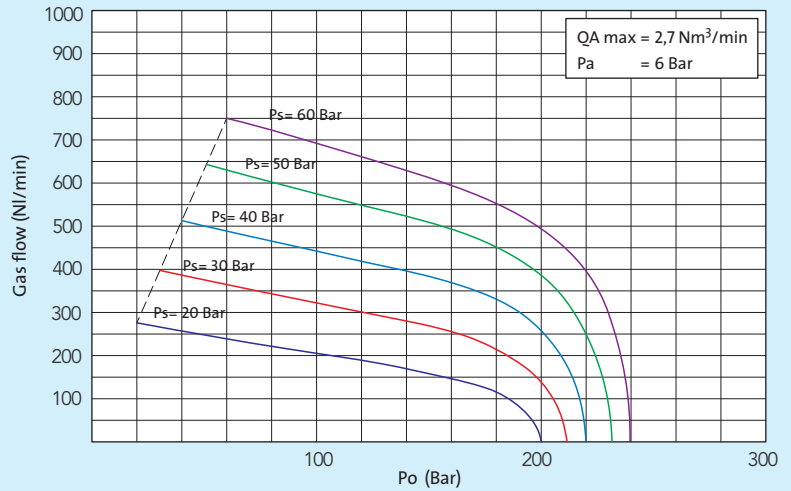

B160-5-30

QA = Air flow
 Pa = Air drive pressure
 Ps = Supply pressure
 Po = Outlet pressure

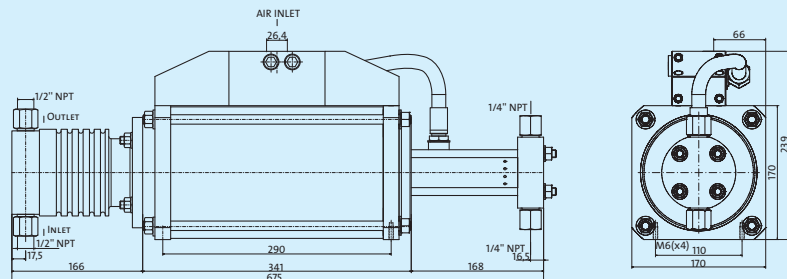

TECHNICAL DATA	B160-5-30
Pressure ratio	1:5/1:30
Max. compression ratio	1:100
Stroke volume ratio	1:6
Stroke volume	385 cc
Minimal supply pressure (Ps)	2,0 bar (30 psi)
Maximum supply pressure (Ps)	1 x Pa
Actual gas outlet pressure (Po)	30 x Pa + 6 x Ps
Max. outlet pressure (Po)	210 bar (3050 psi)
Air drive pressure (Pa)	1-7 bar (14-100 psi)
Air supply connection	3/4" BSP-F
Gas supply connection	1/2" NPT-F
Outlet connection	1/4" NPT-F
Weight	22 kg

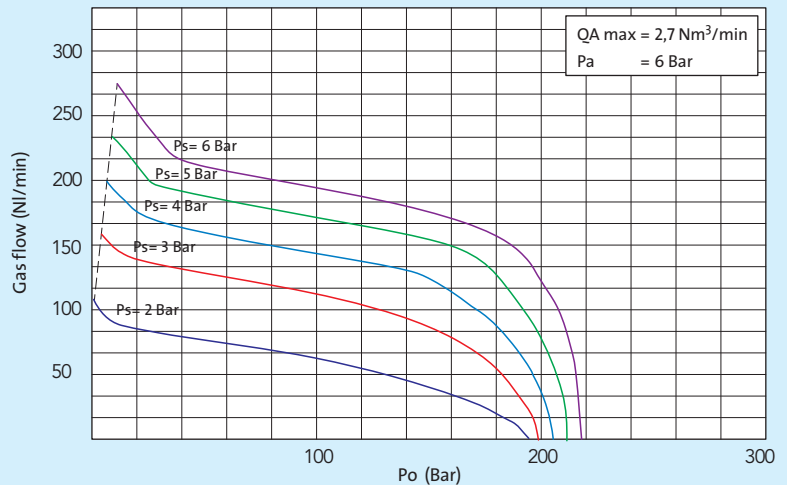

BOOSTERS FOR PRESSURE UP TO 250 BAR

B160-15-30

QA = Air flow
 Pa = Air drive pressure
 Ps = Supply pressure
 Po = Outlet pressure

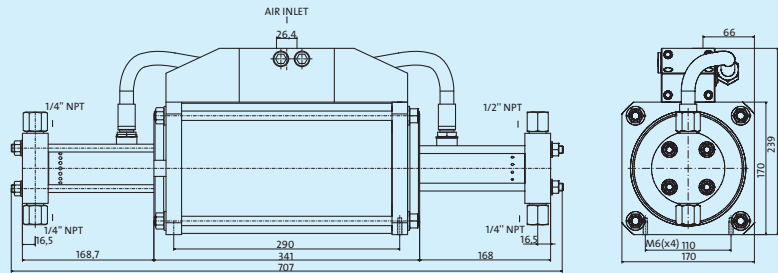

TECHNICAL DATA	B160-15-30
Pressure ratio	1:15/1:30
Max. compression ratio	1:30
Stroke volume ratio	1:2
Stroke volume	125 cc
Minimal supply pressure (Ps)	8,3 bar (120 psi)
Maximum supply pressure (Ps)	15 x Pa
Actual gas outlet pressure (Po)	30 x Pa + 2 x Ps
Max. outlet pressure (Po)	250 bar (3625 psi)
Air drive pressure (Pa)	1-7 bar (14-100 psi)
Air supply connection	3/4" BSP-F
Gas supply connection	1/4" NPT-F
Outlet connection	1/4" NPT-F
Weight	22 kg

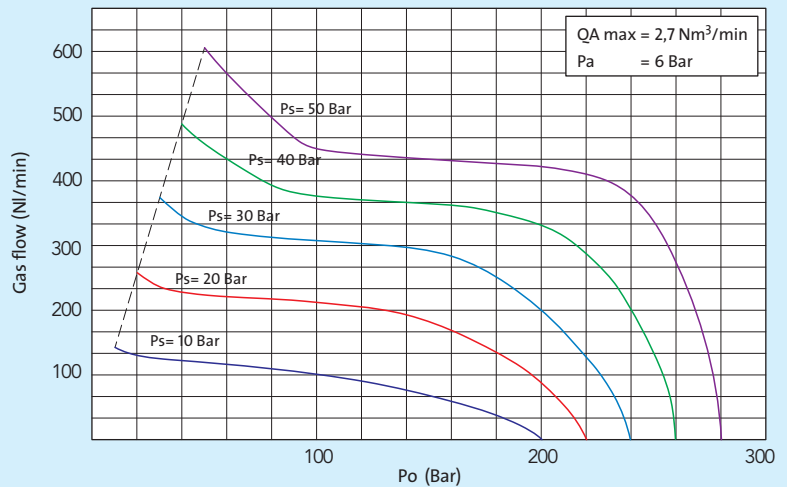

BOOSTERS FOR PRESSURE UP TO 350 BAR

B160-40-1

QA = Air flow
 Pa = Air drive pressure
 Ps = Supply pressure
 Po = Outlet pressure

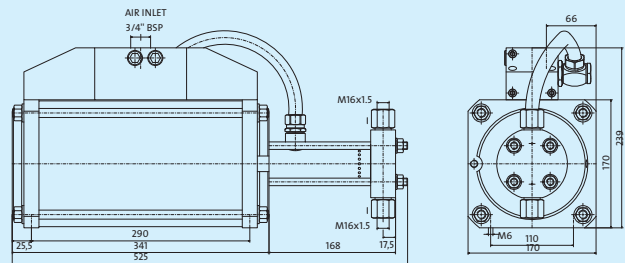

TECHNICAL DATA	B160-40-1
Pressure ratio	1:40
Max. compression ratio	1:15
Stroke volume ratio	-
Stroke volume	50 cc
Minimal supply pressure (Ps)	19,1 bar (275 psi)
Maximum supply pressure (Ps)	285 bar (4130 psi)
Actual gas outlet pressure (Po)	40 x Pa
Max. outlet pressure (Po)	285 bar (4130 psi)
Air drive pressure (Pa)	1-7 bar (14-100 psi)
Air supply connection	3/4" BSP-F
Gas supply connection	M16x1,5 HP-F
Outlet connection	M16x1,5 HP-F
Weight	17,5 kg

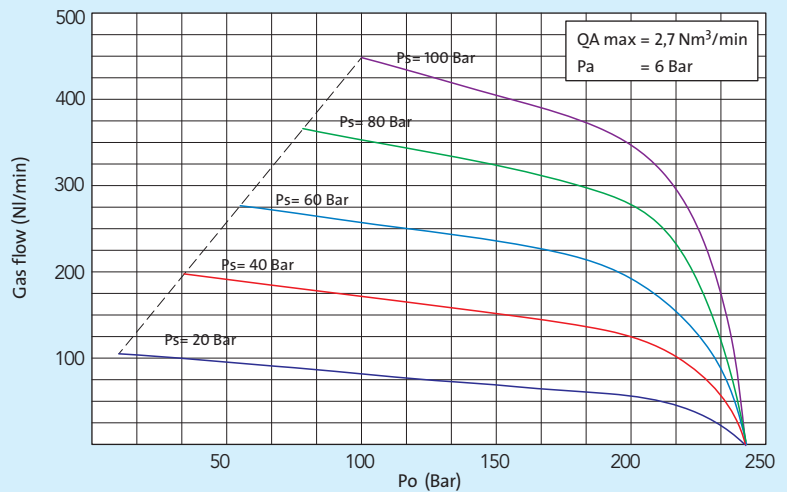

BOOSTERS FOR PRESSURE UP TO 350 BAR

B160-40-2

QA = Air flow
 Pa = Air drive pressure
 Ps = Supply pressure
 Po = Outlet pressure

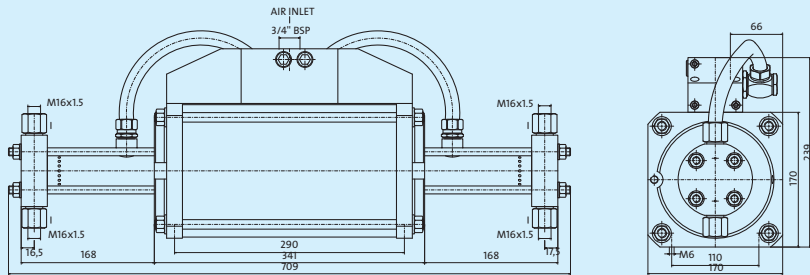

TECHNICAL DATA	B160-40-2
Pressure ratio	1:40
Max. compression ratio	1:15
Stroke volume ratio	-
Stroke volume	100 cc
Minimal supply pressure (Ps)	18,9 bar (275 psi)
Maximum supply pressure (Ps)	285 bar (4130 psi)
Actual gas outlet pressure (Po)	40 x Pa + Ps
Max. outlet pressure (Po)	285 bar (4130 psi)
Air drive pressure (Pa)	1-7 bar (14-100 psi)
Air supply connection	3/4" BSP-F
Gas supply connection	M16x1,5 HP-F
Outlet connection	M16x1,5 HP-F
Weight	22 kg

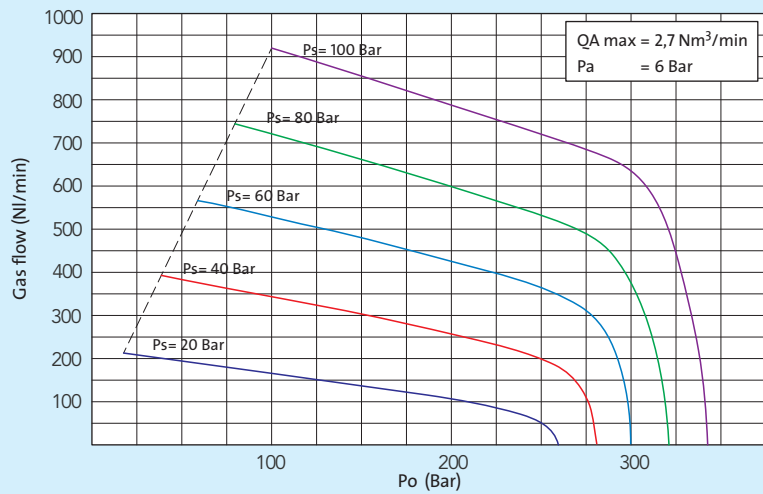

B200-45-2

QA = Air flow
 Pa = Air drive pressure
 Ps = Supply pressure
 Po = Outlet pressure

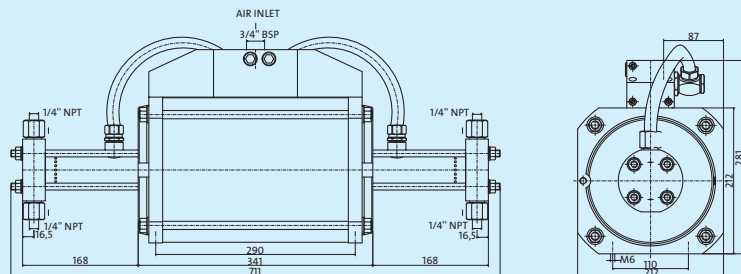

TECHNICAL DATA	B200-45-2
Pressure ratio	1:45
Max. compression ratio	1:15
Stroke volume ratio	-
Stroke volume	140 cc
Minimal supply pressure (Ps)	20,6 bar (300 psi)
Maximum supply pressure (Ps)	310 bar (4495 psi)
Actual gas outlet pressure (Po)	45 x Pa + Ps
Max. outlet pressure (Po)	310 bar (4495 psi)
Air drive pressure (Pa)	1-7 bar (14-100 psi)
Air supply connection	3/4" BSP-F
Gas supply connection	1/4" NPT-F
Outlet connection	1/4" NPT-F
Weight	29 kg

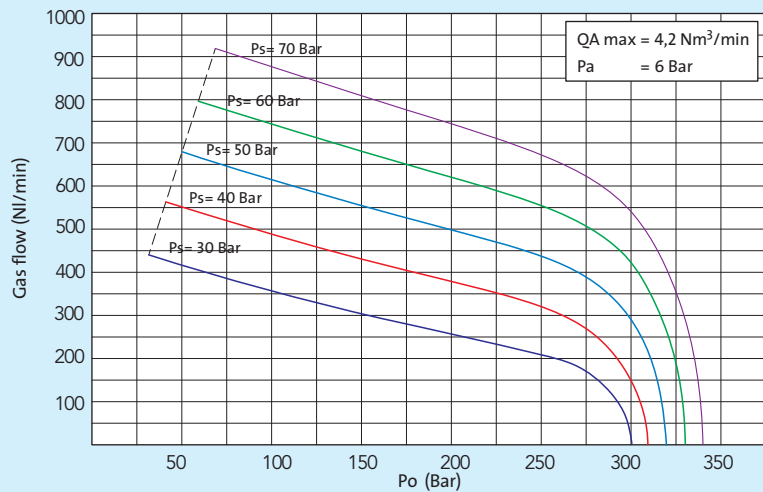

BOOSTERS FOR PRESSURE UP TO 350 BAR

B200-15-45

QA = Air flow
 Pa = Air drive pressure
 Ps = Supply pressure
 Po = Outlet pressure

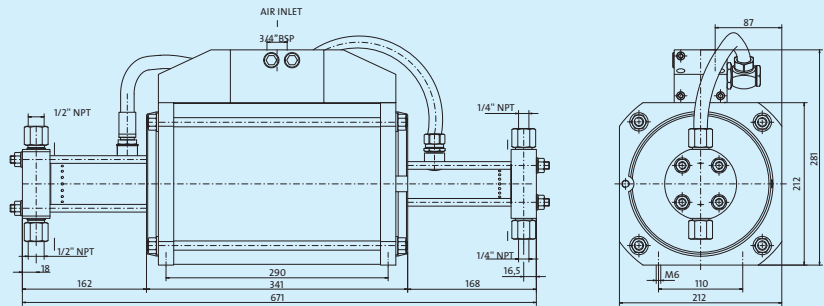

TECHNICAL DATA	B200-15-45
Pressure ratio	1:15/1:45
Max. compression ratio	1:40
Stroke volume ratio	1:3
Stroke volume	200 cc
Minimal supply pressure (Ps)	8,1 bar (115 psi)
Maximum supply pressure (Ps)	7,5 x Pa
Actual gas outlet pressure (Po)	45 x Pa + 3 x Ps
Max. outlet pressure (Po)	325 bar (4715 psi)
Air drive pressure (Pa)	1-7 bar (14-100 psi)
Air supply connection	3/4" BSP-F
Gas supply connection	1/2" NPT-F
Outlet connection	1/4" NPT-F
Weight	29 kg

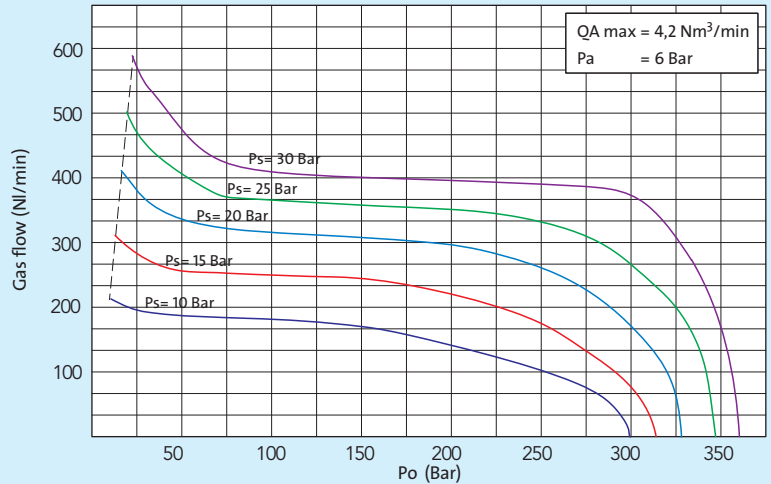

BOOSTERS FOR PRESSURE UP TO 500 BAR

B160-65-2

QA = Air flow
 Pa = Air drive pressure
 Ps = Supply pressure
 Po = Outlet pressure

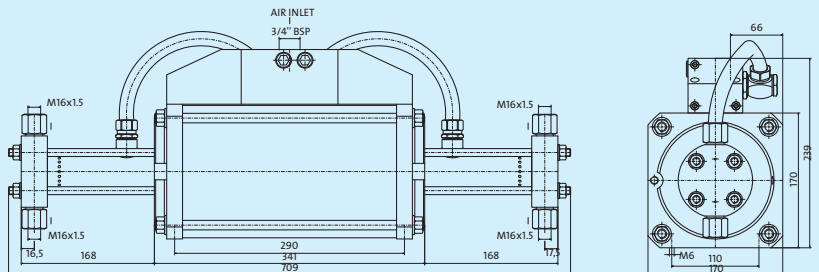

TECHNICAL DATA	B160-65-2
Pressure ratio	1:65
Max. compression ratio	1:15
Stroke volume ratio	-
Stroke volume	60 cc
Minimal supply pressure (Ps)	29,6 bar (430 psi)
Maximum supply pressure (Ps)	450 bar (6525 psi)
Actual gas outlet pressure (Po)	65 x Pa + Ps
Max. outlet pressure (Po)	450 bar (6525 psi)
Air drive pressure (Pa)	1-7 bar (14-100 psi)
Air supply connection	3/4" BSP-F
Gas supply connection	M16x1,5 HP-F
Outlet connection	M16x1,5 HP-F
Weight	22 kg

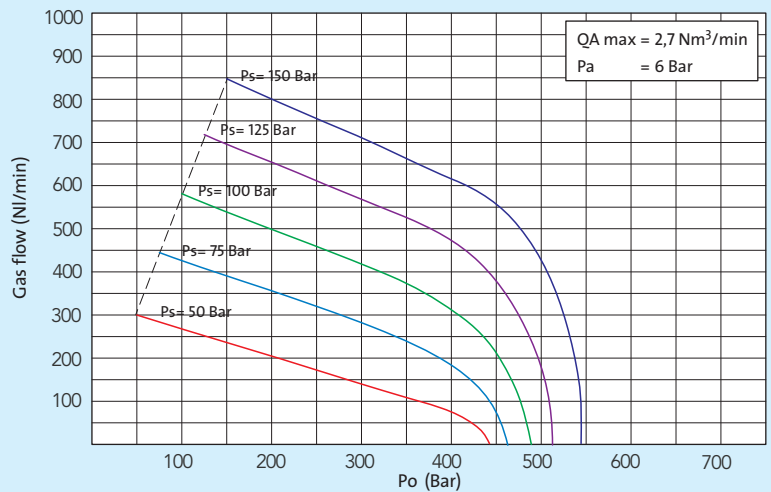

BOOSTERS FOR PRESSURE UP TO 500 BAR

B200-65-2

QA = Air flow
 Pa = Air drive pressure
 Ps = Supply pressure
 Po = Outlet pressure

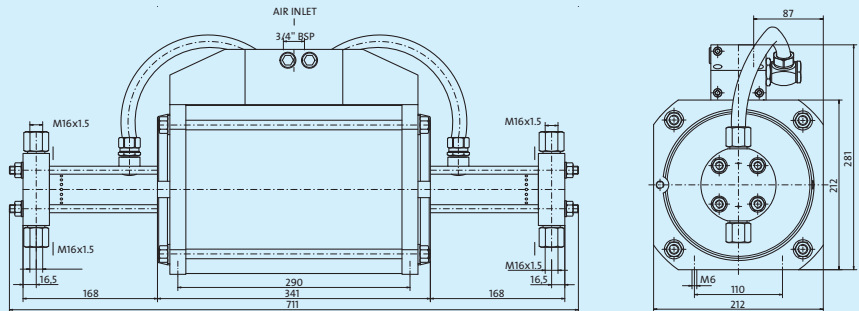

TECHNICAL DATA	B200-65-2
Pressure ratio	1:65
Max. compression ratio	1:15
Stroke volume ratio	-
Stroke volume	100 cc
Minimal supply pressure (Ps)	29,7 bar (430 psi)
Maximum supply pressure (Ps)	450 bar (6525 psi)
Actual gas outlet pressure (Po)	65 x Pa + Ps
Max. outlet pressure (Po)	450 bar (6525 psi)
Air drive pressure (Pa)	1-7 bar (14-100 psi)
Air supply connection	3/4" BSP-F
Gas supply connection	M16x1,5 HP-F
Outlet connection	M16x1,5 HP-F
Weight	29 kg

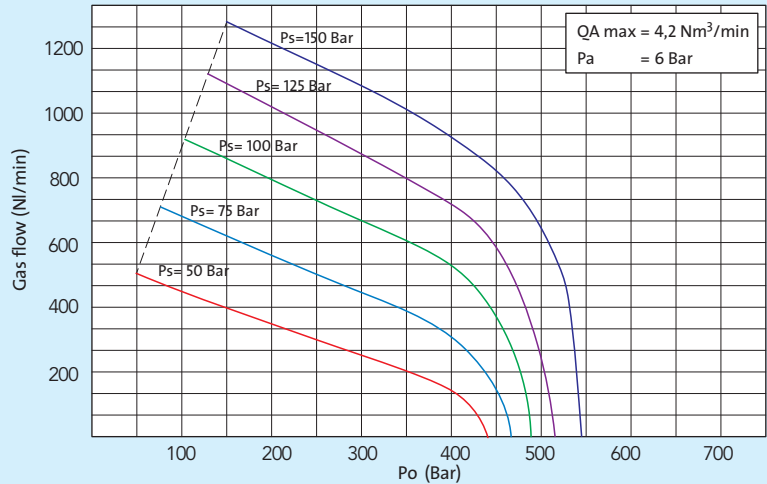

B160-65-1

QA = Air flow
 Pa = Air drive pressure
 Ps = Supply pressure
 Po = Outlet pressure

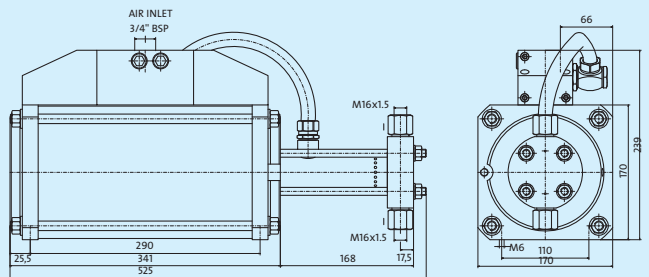

TECHNICAL DATA	B160-65-1
Pressure ratio	1:65
Max. compression ratio	1:15
Stroke volume ratio	-
Stroke volume	30 cc
Minimal supply pressure (Ps)	29,9 bar (435 psi)
Maximum supply pressure (Ps)	450 bar (6525 psi)
Actual gas outlet pressure (Po)	65 x Pa
Max. outlet pressure (Po)	450 bar (6525 psi)
Air drive pressure (Pa)	1-7 bar (14-100 psi)
Air supply connection	3/4" BSP-F
Gas supply connection	M16x1,5 HP-F
Outlet connection	M16x1,5 HP-F
Weight	17,5 kg

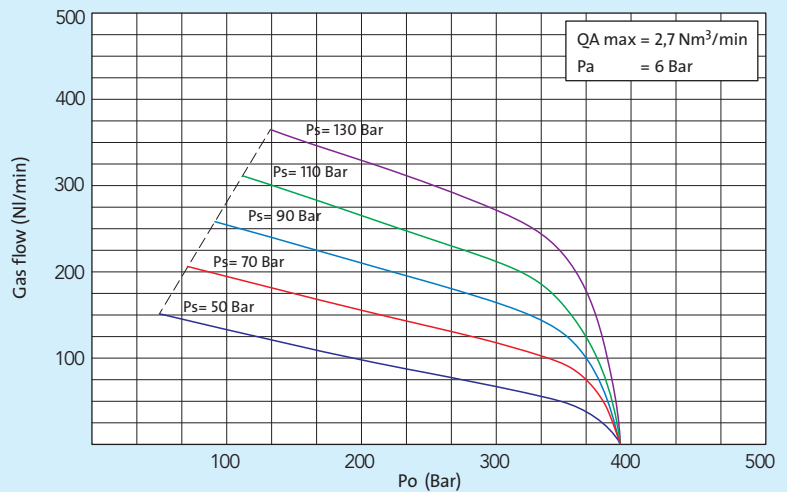

BOOSTERS FOR PRESSURE UP TO 500 BAR

B160-15-65

QA = Air flow
 Pa = Air drive pressure
 Ps = Supply pressure
 Po = Outlet pressure

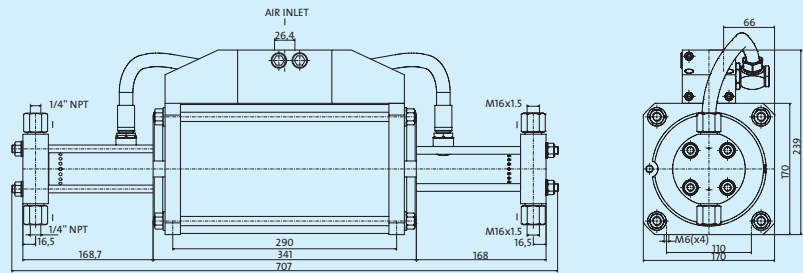

TECHNICAL DATA	B160-15-65
Pressure ratio	1:15/1:65
Max. compression ratio	1:60
Stroke volume ratio	1:4
Stroke volume	125 cc
Minimal supply pressure (Ps)	7,5 bar (110 psi)
Maximum supply pressure (Ps)	4,5 x Pa
Actual gas outlet pressure (Po)	65 x Pa + 4 x Ps
Max. outlet pressure (Po)	450 bar (6525 psi)
Air drive pressure (Pa)	1-7 bar (14-100 psi)
Air supply connection	3/4" BSP-F
Gas supply connection	1/4" NPT-F
Outlet connection	M16x1,5 HP-F
Weight	22 kg

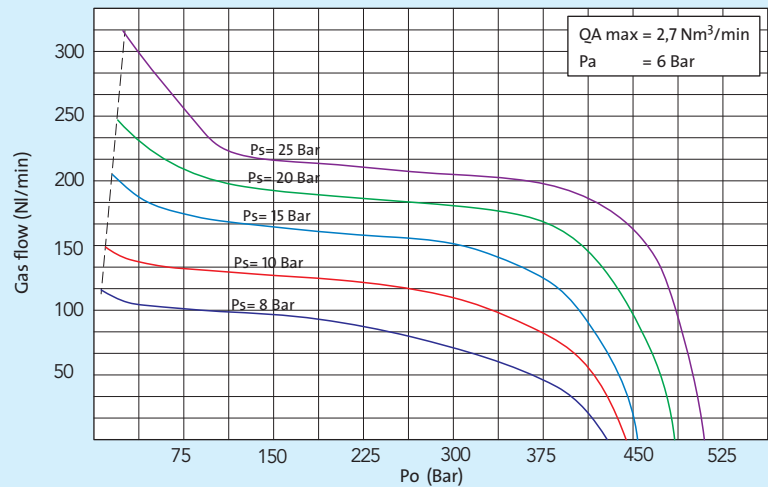

B200-15-65

QA = Air flow
 Pa = Air drive pressure
 Ps = Supply pressure
 Po = Outlet pressure

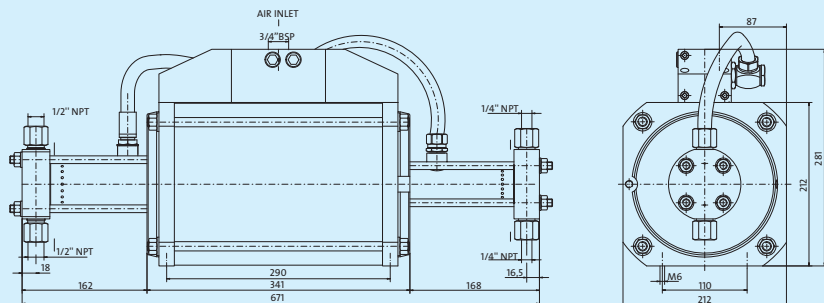

TECHNICAL DATA	B200-15-65
Pressure ratio	1:15/1:65
Max. compression ratio	1:55
Stroke volume ratio	1:4,3
Stroke volume	200 cc
Minimal supply pressure (Ps)	8,2 bar (120 psi)
Maximum supply pressure (Ps)	4,5 x Pa
Actual gas outlet pressure (Po)	65 x Pa + 4,3 x Ps
Max. outlet pressure (Po)	450 bar (6525 psi)
Air drive pressure (Pa)	1-7 bar (14-100 psi)
Air supply connection	3/4" BSP-F
Gas supply connection	1/2" NPT-F
Outlet connection	M16x1,5 HP-F
Weight	29 kg

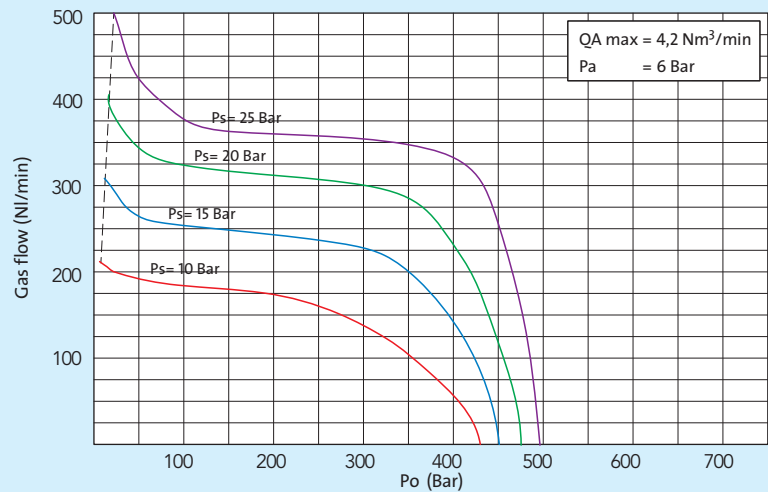

BOOSTERS FOR PRESSURE UP TO 500 BAR

B200-25-65

QA = Air flow
 Pa = Air drive pressure
 Ps = Supply pressure
 Po = Outlet pressure

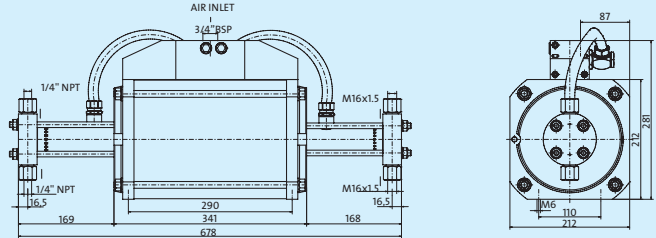

TECHNICAL DATA	B200-25-65
Pressure ratio	1:25/1:65
Max. compression ratio	1:40
Stroke volume ratio	1:2,6
Stroke volume	125 cc
Minimal supply pressure (Ps)	12,2 bar (175 psi)
Maximum supply pressure (Ps)	15,6 x Pa
Actual gas outlet pressure (Po)	65 x Pa + 2,6 x Ps
Max. outlet pressure (Po)	485 bar (7030 psi)
Air drive pressure (Pa)	1-7 bar (14-100 psi)
Air supply connection	3/4" BSP-F
Gas supply connection	1/4" NPT-F
Outlet connection	M16x1,5 HP-F
Weight	29 kg

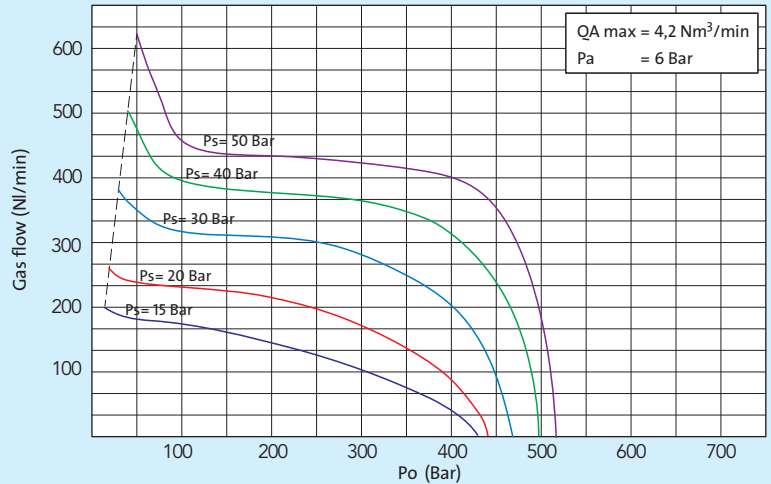

BOOSTERS FOR PRESSURE UP TO 800 BAR

B160-30-65

QA = Air flow
 Pa = Air drive pressure
 Ps = Supply pressure
 Po = Outlet pressure

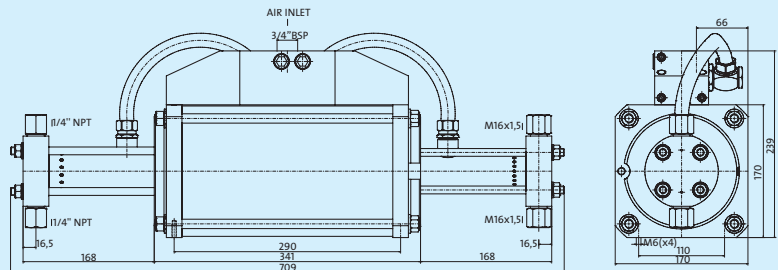

TECHNICAL DATA	B160-30-65
Pressure ratio	1:30/1:65
Max. compression ratio	1:30
Stroke volume ratio	1:2
Stroke volume	70 cc
Minimal supply pressure (Ps)	17,8 bar (260 psi)
Maximum supply pressure (Ps)	25,5 x Pa
Actual gas outlet pressure (Po)	65 x Pa + 2 x Ps
Max. outlet pressure (Po)	535 bar (7760 psi)
Air drive pressure (Pa)	1-7 bar (14-100 psi)
Air supply connection	3/4" BSP-F
Gas supply connection	1/4" NPT-F
Outlet connection	M16x1,5 HP-F
Weight	22 kg

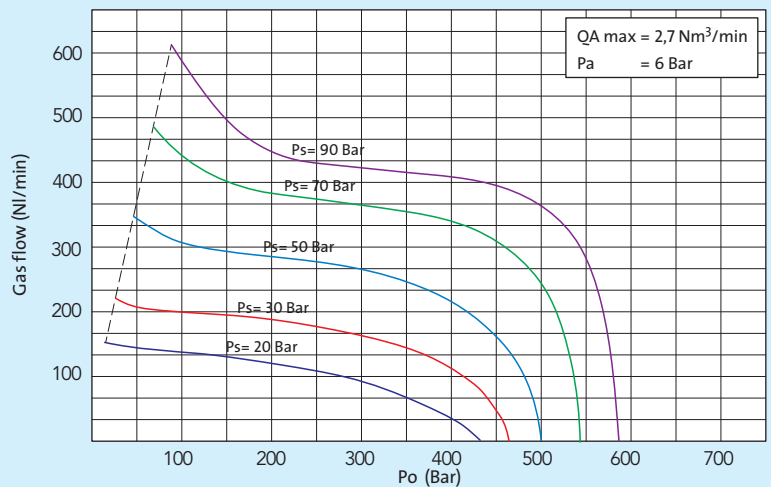

BOOSTERS FOR PRESSURE UP TO 800 BAR

B200-100-2

QA = Air flow
Pa = Air drive pressure
Ps = Supply pressure
Po = Outlet pressure

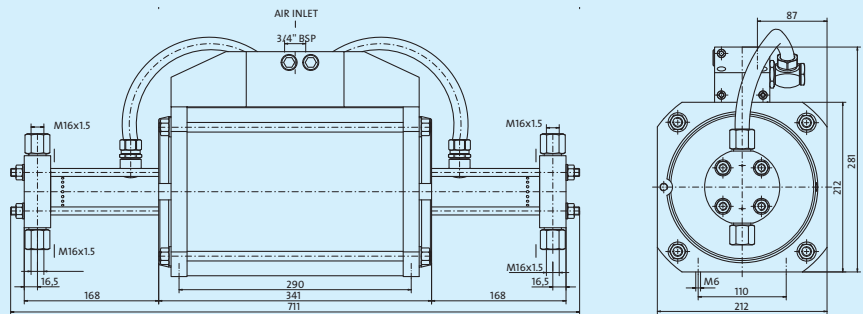

TECHNICAL DATA	B200-100-2
Pressure ratio	1:100
Max. compression ratio	1:15
Stroke volume ratio	-
Stroke volume	60 cc
Minimal supply pressure (Ps)	46,4 bar (670 psi)
Maximum supply pressure (Ps)	695 bar (10080 psi)
Actual gas outlet pressure (Po)	100 x Pa + Ps
Max. outlet pressure (Po)	695 bar (10080 psi)
Air drive pressure (Pa)	1-7 bar (14-100 psi)
Air supply connection	3/4" BSP-F
Gas supply connection	M16x1,5 HP-F
Outlet connection	M16x1,5 HP-F
Weight	29 kg

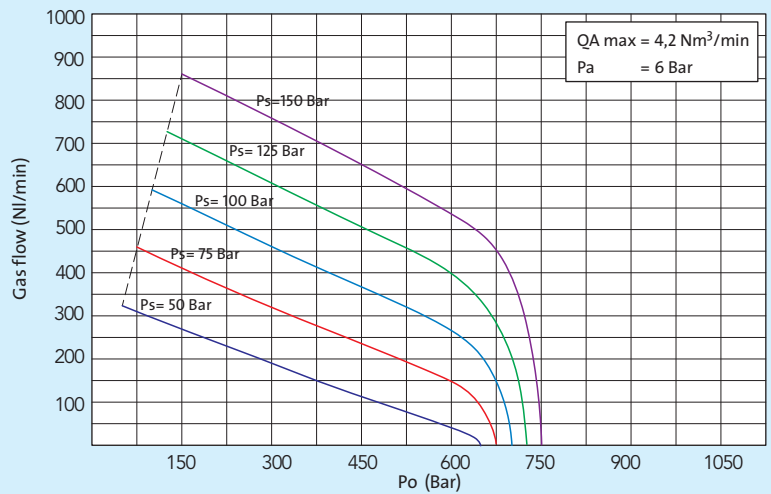

B200-25-100

QA = Air flow
Pa = Air drive pressure
Ps = Supply pressure
Po = Outlet pressure

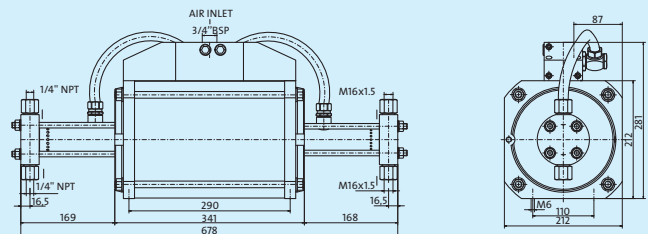

TECHNICAL DATA	B200-25-100
Pressure ratio	1:25/1:100
Max. compression ratio	1:60
Stroke volume ratio	1:4
Stroke volume	125 cc
Minimal supply pressure (Ps)	11,8 bar (170 psi)
Maximum supply pressure (Ps)	8,3 x Pa
Actual gas outlet pressure (Po)	100 x Pa + 4 x Ps
Max. outlet pressure (Po)	710 bar (10295 psi)
Air drive pressure (Pa)	1-7 bar (14-100 psi)
Air supply connection	3/4" BSP-F
Gas supply connection	1/4" NPT-F
Outlet connection	M16x1,5 HP-F
Weight	29 kg

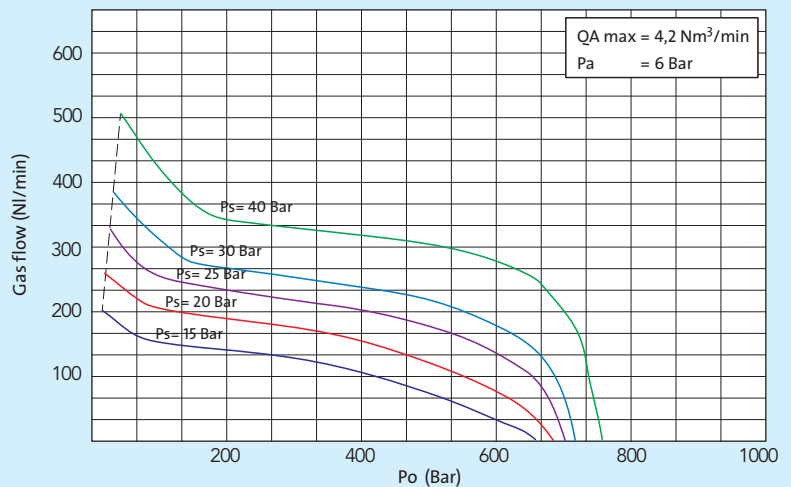

BOOSTERS FOR PRESSURE UP TO 800 BAR

B200-45-100

QA = Air flow
 Pa = Air drive pressure
 Ps = Supply pressure
 Po = Outlet pressure

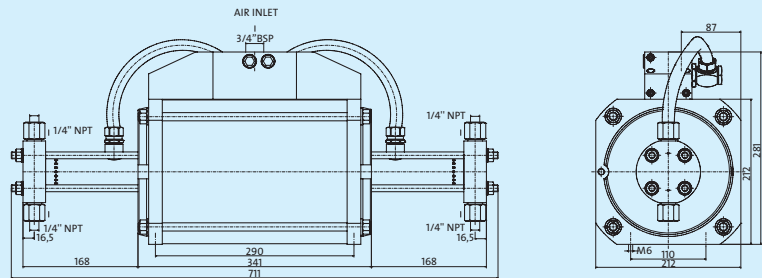

TECHNICAL DATA	B200-45-100
Pressure ratio	1:45/1:100
Max. compression ratio	1:60
Stroke volume ratio	1:2,3
Stroke volume	70 cc
Minimal supply pressure (Ps)	2,3 bar (12 psi)
Maximum supply pressure (Ps)	34 x Pa
Actual gas outlet pressure (Po)	100 x Pa + 2,3 x Ps
Max. outlet pressure (Po)	725 bar (10295 psi)
Air drive pressure (Pa)	1-7 bar (14-100 psi)
Air supply connection	3/4" BSP-F
Gas supply connection	M16x1,5 HP-F
Outlet connection	M16x1,5 HP-F
Weight	22 kg

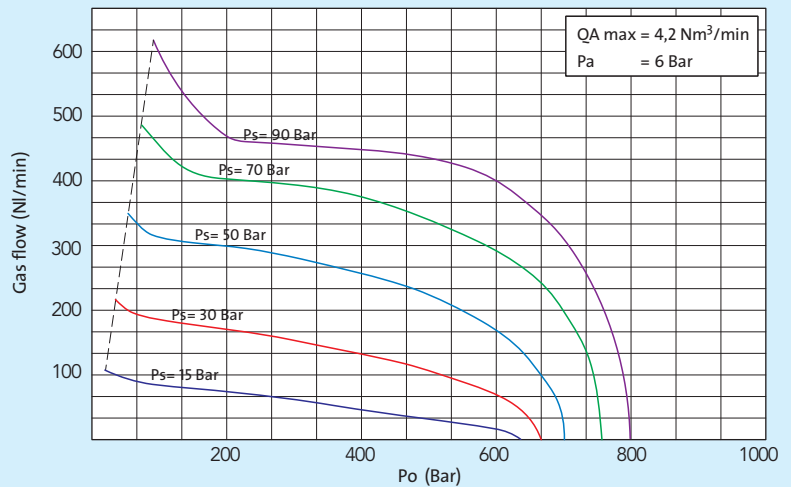

B160-115-2

QA = Air flow
 Pa = Air drive pressure
 Ps = Supply pressure
 Po = Outlet pressure

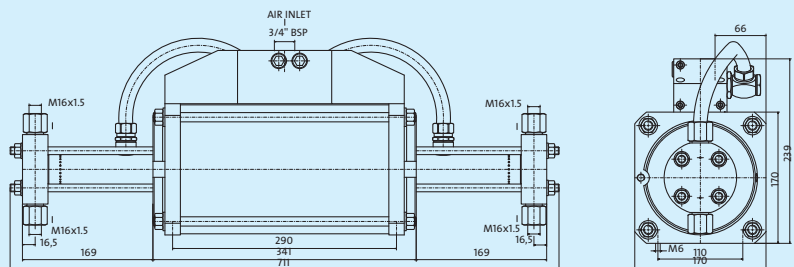

TECHNICAL DATA	B160-115-2
Pressure ratio	1:115
Max. compression ratio	1:15
Stroke volume ratio	-
Stroke volume	36 cc
Minimal supply pressure (Ps)	52,6 bar (760 psi)
Maximum supply pressure (Ps)	800 bar (11600 psi)
Actual gas outlet pressure (Po)	115 x Pa + Ps
Max. outlet pressure (Po)	800 bar (11600 psi)
Air drive pressure (Pa)	1-7 bar (14-100 psi)
Air supply connection	3/4" BSP-F
Gas supply connection	M16x1,5 HP-F
Outlet connection	M16x1,5 HP-F
Weight	22 kg

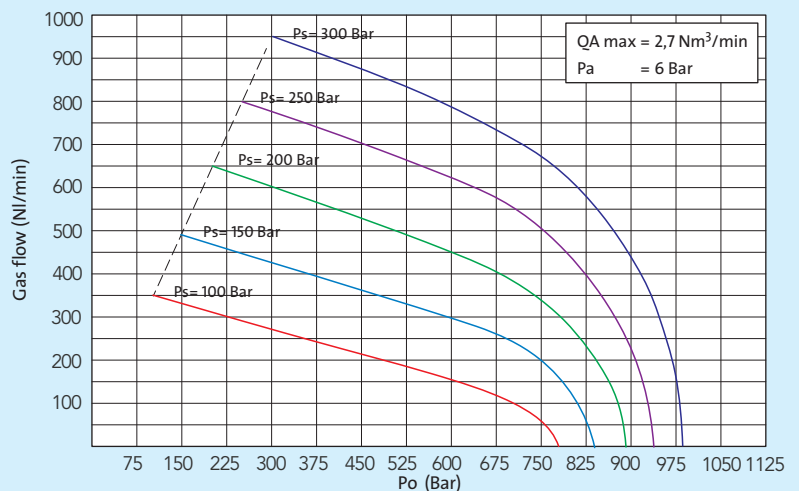

BOOSTERS FOR PRESSURE UP TO 800 BAR

B160-115-1

QA = Air flow
 Pa = Air drive pressure
 Ps = Supply pressure
 Po = Outlet pressure

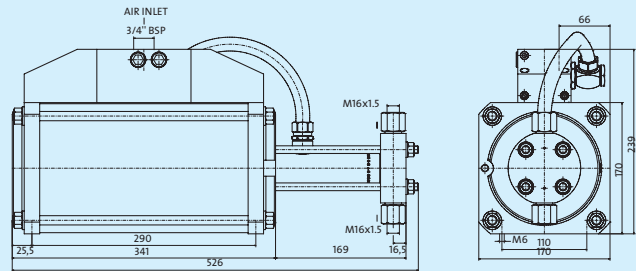

TECHNICAL DATA	B160-115-1
Pressure ratio	1:115
Max. compression ratio	1:15
Stroke volume ratio	-
Stroke volume	18 cc
Minimal supply pressure (Ps)	53,1 bar (770 psi)
Maximum supply pressure (Ps)	800 bar (11600 psi)
Actual gas outlet pressure (Po)	115 x Pa
Max. outlet pressure (Po)	800 bar (11600 psi)
Air drive pressure (Pa)	1-7 bar (11600 psi)
Air supply connection	3/4" BSP-F
Gas supply connection	M16x1,5 HP-F
Outlet connection	M16x1,5 HP-F
Weight	17,5 kg

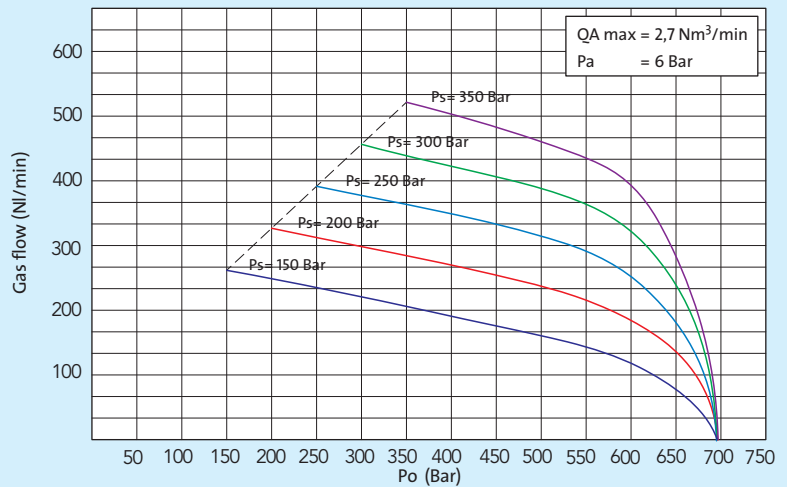

B160-30-115

QA = Air flow
 Pa = Air drive pressure
 Ps = Supply pressure
 Po = Outlet pressure

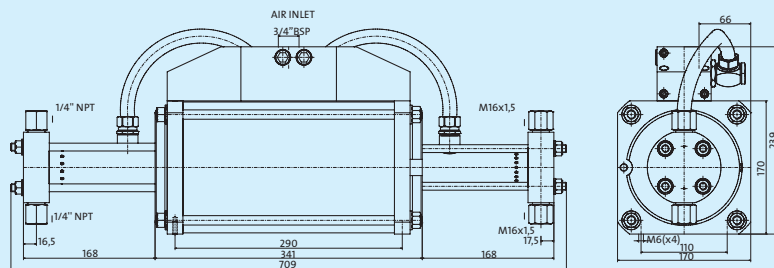

TECHNICAL DATA	B160-30-115
Pressure ratio	1:30/1:115
Max. compression ratio	1:50
Stroke volume ratio	1:4
Stroke volume	70 cc
Minimal supply pressure (Ps)	16,1 bar (230 psi)
Maximum supply pressure (Ps)	10,5 x Pa
Actual gas outlet pressure (Po)	115 x Pa + 4 x Ps
Max. outlet pressure (Po)	805 bar (11670 psi)
Air drive pressure (Pa)	1-7 bar (14-100 psi)
Air supply connection	3/4" BSP-F
Gas supply connection	1/4" NPT-F
Outlet connection	M16x1,5 HP-F
Weight	22 kg

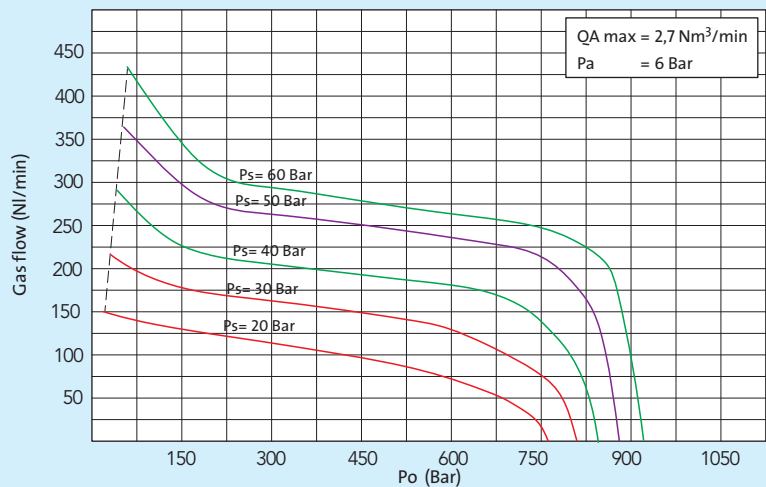

BOOSTERS FOR PRESSURE UP TO 1350 BAR

B160-180-2

QA = Air flow
 Pa = Air drive pressure
 Ps = Supply pressure
 Po = Outlet pressure

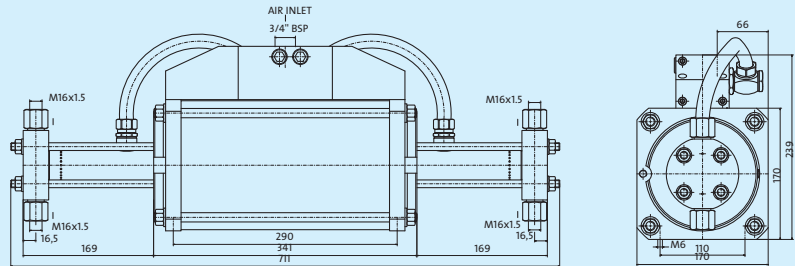

TECHNICAL DATA	B160-180-2
Pressure ratio	1:180
Max. compression ratio	1:15
Stroke volume ratio	-
Stroke volume	22,6 cc
Minimal supply pressure (Ps)	82,2 bar (1190 psi)
Maximum supply pressure (Ps)	1260 bar (18270 psi)
Actual gas outlet pressure (Po)	$180 \times Pa + Ps$
Max. outlet pressure (Po)	1260 bar (18270 psi)
Air drive pressure (Pa)	1-7 bar (14-100 psi)
Air supply connection	3/4" BSP-F
Gas supply connection	M16x1,5 HP-F
Outlet connection	M16x1,5 HP-F
Weight	22 kg

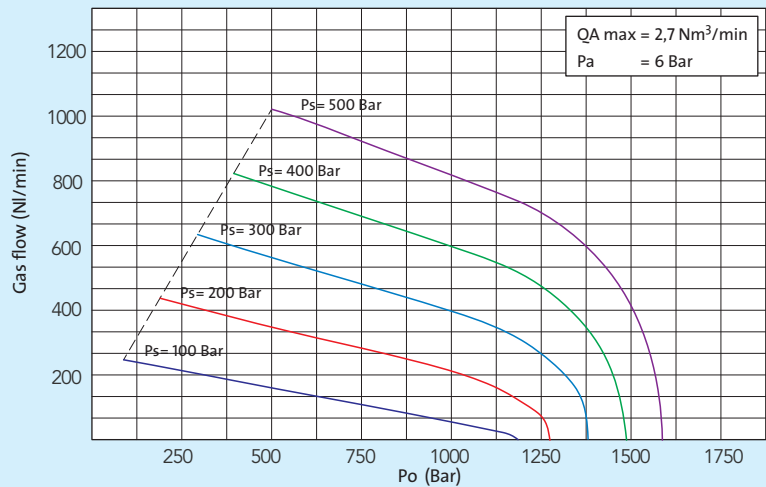

B200-180-2

QA = Air flow
 Pa = Air drive pressure
 Ps = Supply pressure
 Po = Outlet pressure

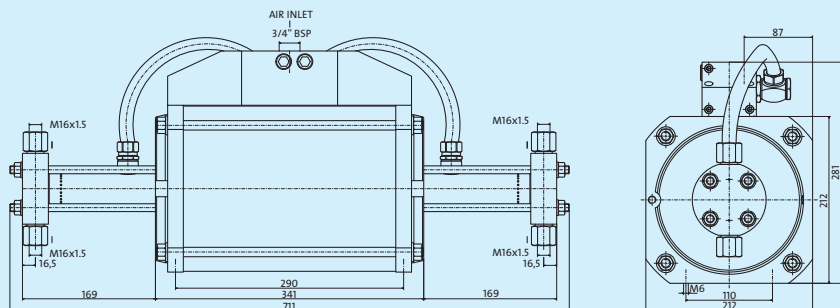

TECHNICAL DATA	B200-180-2
Pressure ratio	1:180
Max. compression ratio	1:15
Stroke volume ratio	-
Stroke volume	36 cc
Minimal supply pressure (Ps)	82,5 bar (1195 psi)
Maximum supply pressure (Ps)	1260 bar (18270 psi)
Actual gas outlet pressure (Po)	$180 \times Pa + Ps$
Max. outlet pressure (Po)	1260 bar (18270 psi)
Air drive pressure (Pa)	1-7 bar (14-100 psi)
Air supply connection	3/4" BSP-F
Gas supply connection	M16x1,5 HP-F
Outlet connection	M16x1,5 HP-F
Weight	29 kg

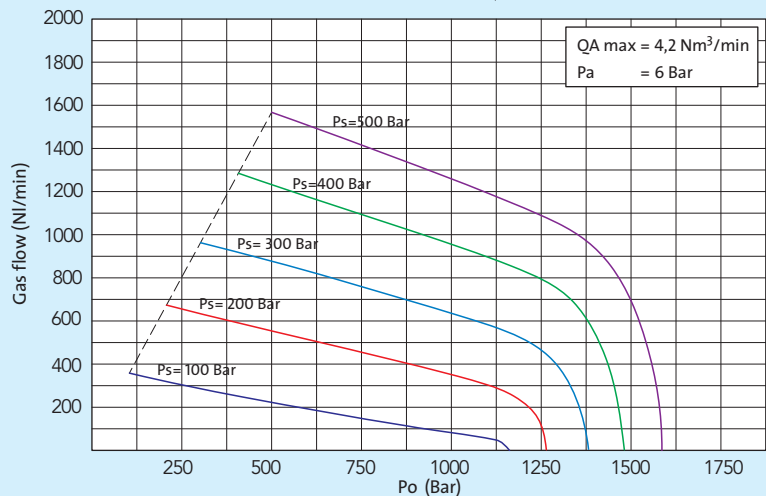

BOOSTERS FOR PRESSURE UP TO 1350 BAR

B160-180-1

QA = Air flow
 Pa = Air drive pressure
 Ps = Supply pressure
 Po = Outlet pressure

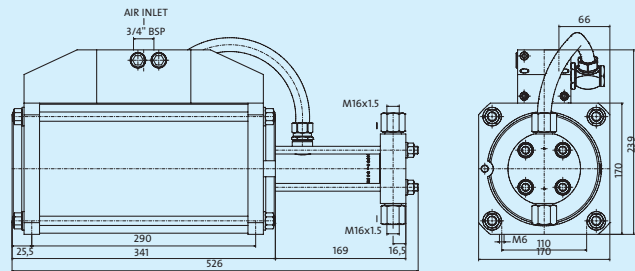

TECHNICAL DATA	B160-180-1
Pressure ratio	1:180
Max. compression ratio	1:15
Stroke volume ratio	-
Stroke volume	11,3 cc
Minimal supply pressure (Ps)	83 bar (1200 psi)
Maximum supply pressure (Ps)	1260 bar (18270 psi)
Actual gas outlet pressure (Po)	180 x Pa
Max. outlet pressure (Po)	1260 bar (18270 psi)
Air drive pressure (Pa)	1-7 bar (14-100 psi)
Air supply connection	3/4" BSP-F
Gas supply connection	M16x1,5 HP-F
Outlet connection	M16x1,5 HP-F
Weight	17,5 kg

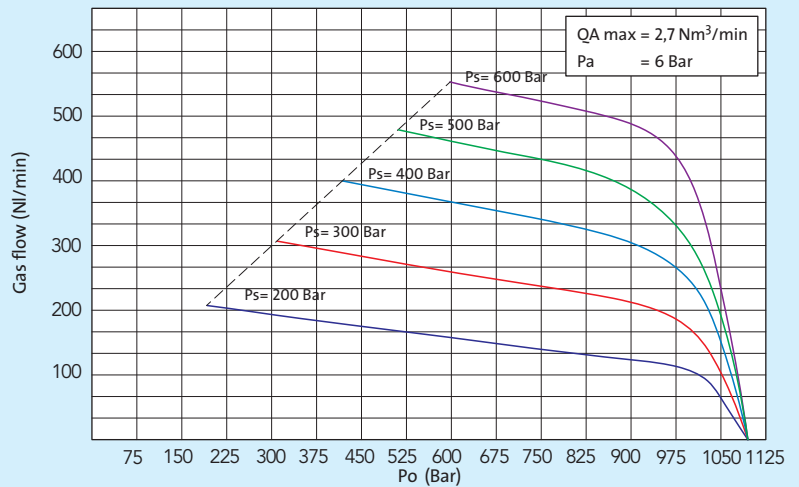

B160-30-180

QA = Air flow
 Pa = Air drive pressure
 Ps = Supply pressure
 Po = Outlet pressure

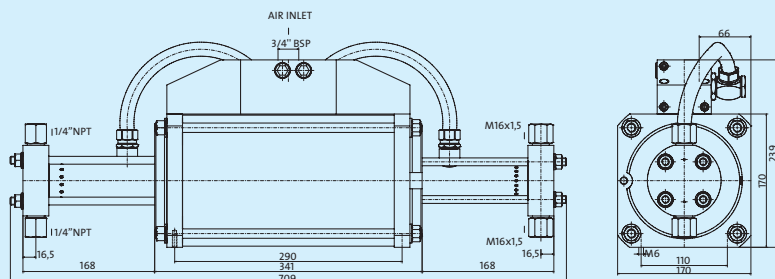

TECHNICAL DATA	B160-30-180
Pressure ratio	1:30/1:180
Max. compression ratio	1:80
Stroke volume ratio	1:6
Stroke volume	70 cc
Minimal supply pressure (Ps)	15,6 bar (225 psi)
Maximum supply pressure (Ps)	6 x Pa
Actual gas outlet pressure (Po)	180 x Pa + 6 x Ps
Max. outlet pressure (Po)	1330 bar (19285 psi)
Air drive pressure (Pa)	1-7 bar (14-100 psi)
Air supply connection	3/4" BSP-F
Gas supply connection	1/4" NPT-F
Outlet connection	M16x1,5 HP-F
Weight	22 kg

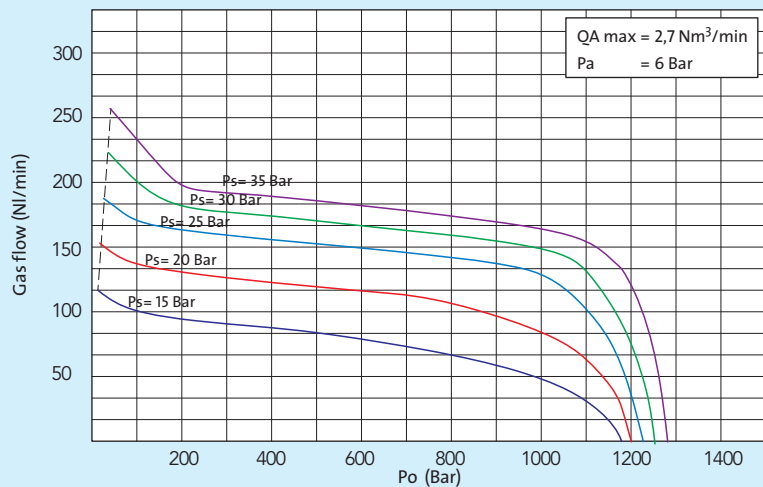

BOOSTERS FOR PRESSURE UP TO 1350 BAR

B160-65-180

QA = Air flow
 Pa = Air drive pressure
 Ps = Supply pressure
 Po = Outlet pressure

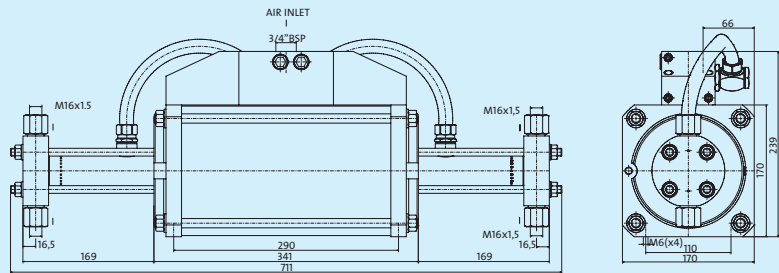

TECHNICAL DATA	B160-65-180
Pressure ratio	1:65/1:180
Max. compression ratio	1:40
Stroke volume ratio	1:3
Stroke volume	30 cc
Minimal supply pressure (Ps)	33,3 bar (480 psi)
Maximum supply pressure (Ps)	36 x Pa
Actual gas outlet pressure (Po)	180 x Pa + 3 x Ps
Max. outlet pressure (Po)	1330 bar (19285 psi)
Air drive pressure (Pa)	1-7 bar (14-100 psi)
Air supply connection	3/4" BSP-F
Gas supply connection	M16x1,5 HP-F
Outlet connection	M16x1,5 HP-F
Weight	22 kg

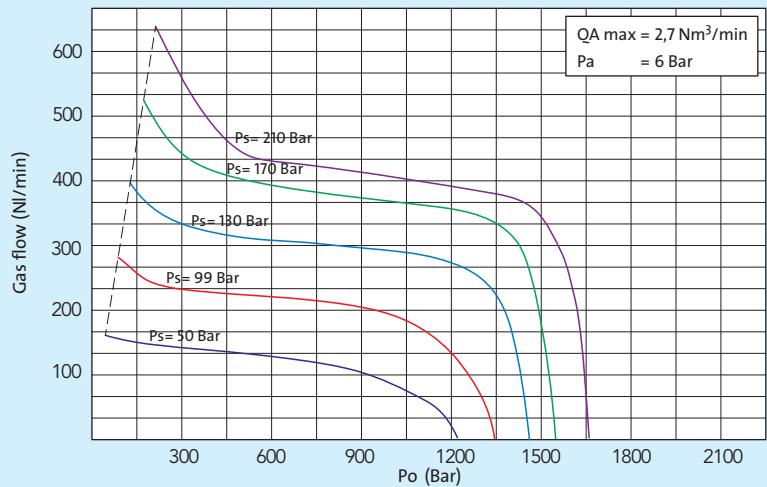

B200-65-180

QA = Air flow
 Pa = Air drive pressure
 Ps = Supply pressure
 Po = Outlet pressure

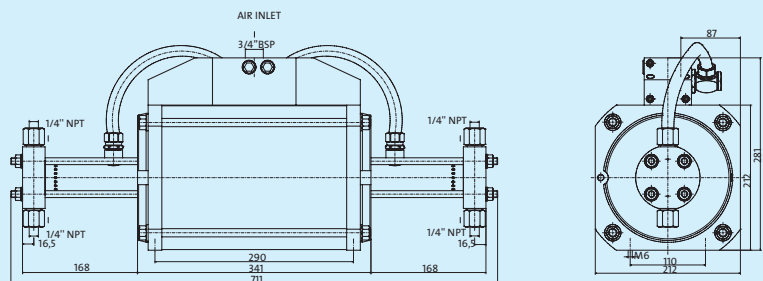

TECHNICAL DATA	B200-65-180
Pressure ratio	1:65/1:180
Max. compression ratio	1:60
Stroke volume ratio	1:2,8
Stroke volume	50 cc
Minimal supply pressure (Ps)	22,2 bar (480 psi)
Maximum supply pressure (Ps)	36,7 x Pa
Actual gas outlet pressure (Po)	180 x Pa + 2,8 x Ps
Max. outlet pressure (Po)	1330 bar (19285 psi)
Air drive pressure (Pa)	1-7 bar (14-100 psi)
Air supply connection	3/4" BSP-F
Gas supply connection	M16x1,5 HP-F
Outlet connection	M16x1,5 HP-F
Weight	29 kg

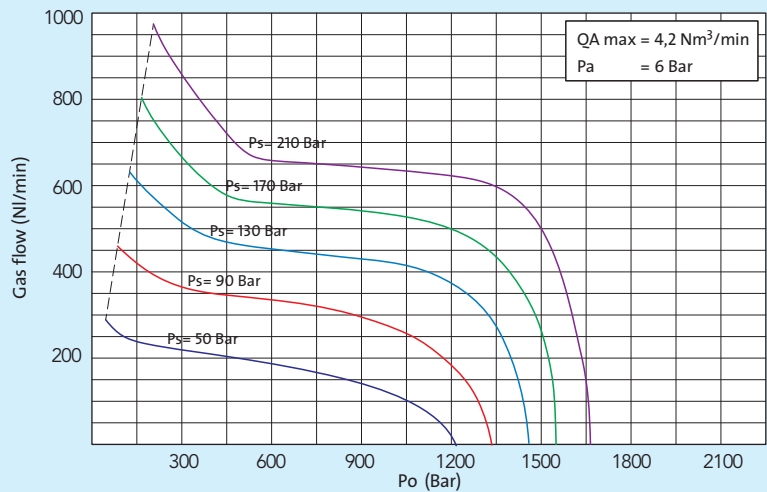

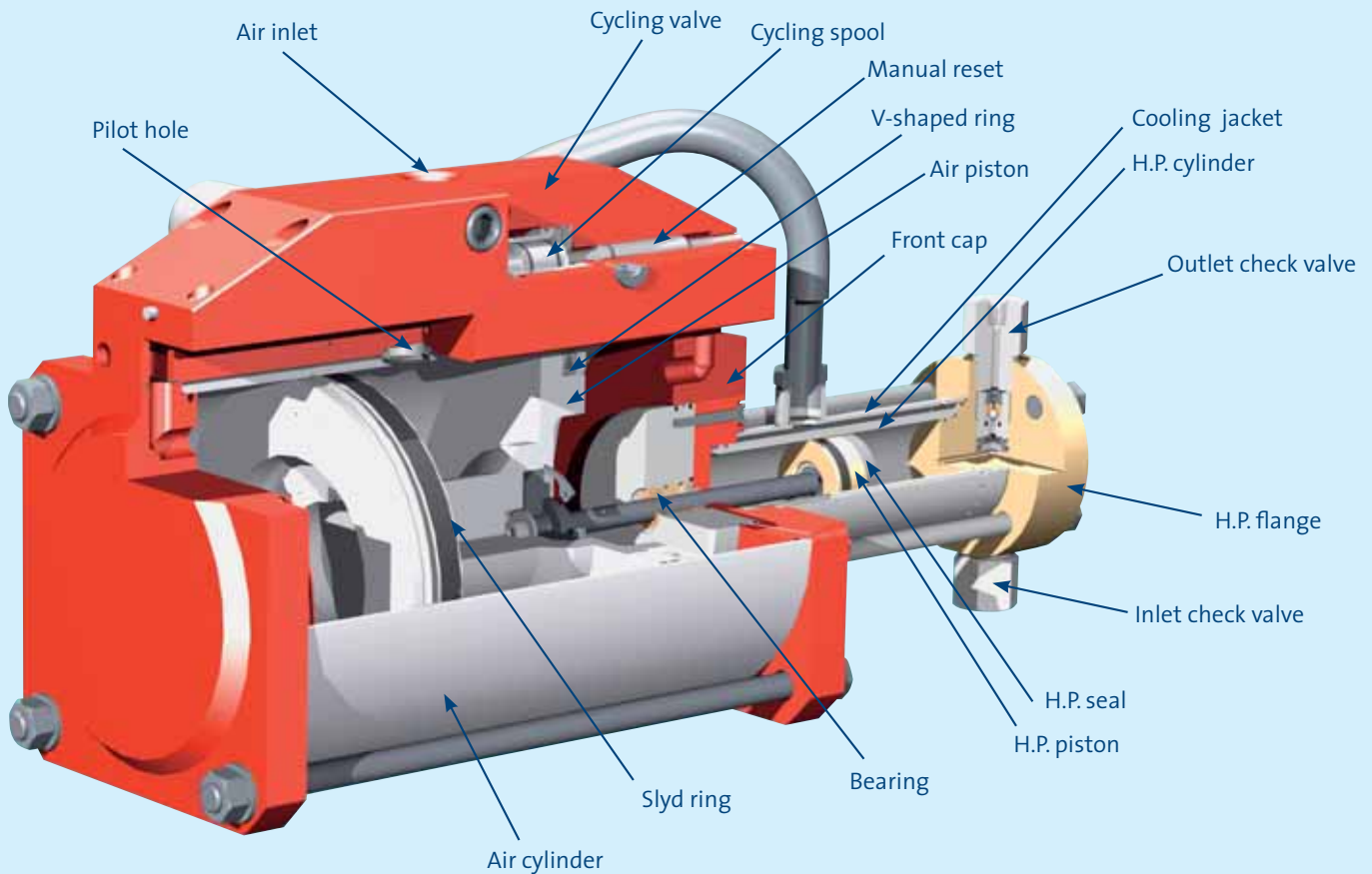

RESATO GAS BOOSTERS B160 AND B200 MATERIAL SPECIFICATIONS

AIR SECTION:

Air piston:	aluminium
Air piston bearings:	PTFE-based slydrings filled with carbon
Air cylinder:	aluminium, hard anodized inside and epoxy coated outside
Cycling valve:	aluminium colour anodized
Bolts and nuts:	stainless steel 1.4301
Air drive end caps:	aluminium colour anodized

HIGH-PRESSURE SECTION:

High pressure cylinder:	bronze RG7; stainless steel 1.4122/15-5PH
High pressure piston:	stainless steel 1.4112/1.3980/17-4PH/ (guiding material: CuSn8)
Check valves:	housing: stainless steel 1.4122/15-5PH balls: ceramic other internal parts: stainless steel 1.4404/17-4PH
Clamping rings:	PVC

SEALINGS:

Check valves:	(Ceramic)
High-pressure piston:	polymer compounds based on low-friction PTFE resins on request
Alternative:	on request
Air piston:	NBR V-shaped rings

STANDARD RANGE PERFORMANCE OF THE HIGH-PRESSURE SEALING

One of the most important features of Resato gas boosters is the high-pressure seal for the high-pressure piston. The standard seals installed offer a long seal life, even for non-lubricating fluids. The seals are suitable for example for:

- Compressed air
- Nitrogen
- Argon

Alternative materials for gas contacted parts and sealings can be selected depending on the media used and on the operating conditions. Please contact Resato International BV for more information.

ACCESSORIES

AIR CONTROLS

Every Resato air driven gas booster must be fitted with a set of air controls to control gas booster performance, to lubricate the air and to prevent dirt and water from entering the air drive section. All air controls for the B160 range have 1/2" BSP connections; air controls for the B200 range have 3/4" BSP connections.

The set of air controls can be delivered as one unit, or as two separate units:

- unit for the B160 range, ordering code C-1/2
- unit for the B200 range, ordering code C-3/4
- filter/water separator with lubricator, ordering code FL-1/2 (B160) or FL-3/4 (B200)
- air pressure regulator, ordering code R-1/2 (B160) or R-3/4 (B200).

For the B160 range a start/stop valve is available which can be connected directly to the air controls. Ordering code for the start/stop valve is V-1/2.

EXHAUST MUFFLER

To suppress noise and prevent ingress of contamination into the air cycling valve, the gas boosters are standard supplied with exhaust mufflers:

- type S-16 for the B160 range
- type S-20 for the B200 range.

If no exhaust muffler is required or available and noise levels are above acceptable, exhaust pipes can be led away to a remote location.

BRACKETS

If for any reason the thread holes in the air drive end caps cannot be used to mount the gas booster, four welding brackets (4) can be used. The nuts of the air cylinder clamping bolts can be used to mount the brackets to the gas booster. Ordering code for the brackets is B-16/20 for booster types B160 and B200.

ADAPTERS

Many booster types have a high-pressure connection (see selection tables). If necessary, Resato can provide high-pressure adapters with UNF high-pressure NPT or BSP thread connections. Please refer to our catalogue of high-pressure fittings, adapters and tubing for more information.

ORDERING EXAMPLE

B200	-	65	-	2	/	EX
Booster range	-	Ratio	-	Double acting	/	Atex version
↓		↓		↓		↓
B160 series B200 series		(refer to table)		single (1) double (2) two stage (eg 15-65)		Standard Atex version (EX) Oxygen clean (OX)

EXAMPLES OF RESATO HIGH-PRESSURE COMPONENTS UP TO 14,000 BAR

Air-driven pumps and gas boosters

Hydraulically-driven pumps and gas boosters

Fittings

General-purpose valves

Check valves

Swivels

Hoses

Tubing

Pressure transducers

Rupture-disc safety devices

Quick connectors

EXAMPLES OF RESATO HIGH-PRESSURE EQUIPMENT AND SYSTEMS

Portable pressure-test systems

Test equipment for hoses (safety) valves, fittings etc.

Computer-controlled high-pressure test equipment

Autofrettage systems

Autoclaves

Custom-made test equipment

Water-jet cutting systems

High-pressure food preservation systems

PC data acquisition and recording systems



COMPANY PROFILE RESATO

Founded in 1985, Resato International B.V. is wholly specialized in the design and manufacture of high-pressure components and systems for pressures of up to 14,000 bar (200,000 psi). At our modern manufacturing plant in Roden, The Netherlands, we have our own engineering and R&D departments as well as sophisticated production facilities. These enable us to furnish precisely the right component or system a client may need.

RESATO INTERNATIONAL BV



1e Energieweg 13
P.O. Box 30

NL-9301 LK
NL-9300 AA

Roden - Holland
Roden - Holland

Phone: +31 (0) 50 501 6877
Fax: +31 (0) 50 501 2402

E-mail: hpsales@resato.com
Internet: www.resato.com

Please note that general data and specifications given in this brochure are subject to change without notice.
Feel free to contact our sales department if you need more definite information.