



# STRIP LAMP LED RECHARGEABLE LAMP ART. 344



**NEW  
TECHNOLOGY**



=

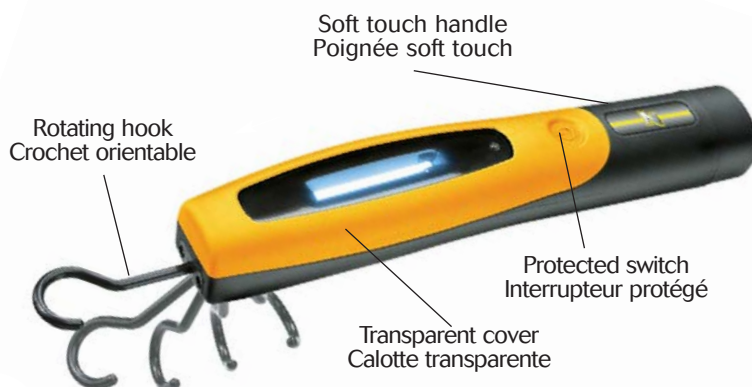

STRIP LAMP: rechargeable and powerful led lamp

## FEATURES

- Luminous source Strip Led
- Luminous flux 360 lm
- Lamp protection degree IP65
- Replaceable transparent cover.
- Protected soft touch switch.
- Rotating hook.
- Run time 3h
- Charging time 2,5h
- Battery NiMH - 2500 mAh
- Battery life (charging / discharging) 500 cycles
- Charger 100÷240 @ 50/60Hz
- Accurate charge control by microprocessor
- Pilot light on the battery charger:
  - fixed red:** the lamp is not inserted, or not correctly inserted;
  - flashing red:** lamp in recharge;
  - fixed green:** the charge is completed. Charge maintenance function.

**ART. 344** – Strip Lamp rechargeable lamp + battery charger.



STRIP LAMP: Lampe rechargeable à Led avec une luminosité maximale.

## CARACTERISTIQUES

- Source de lumière Strip Led
- Flux lumineux 360 lm
- Indice de protection de la lampe IP65
- Calotte transparente remplaçable.
- Interrupteur soft touch, protégé.
- Crochet orientable.
- Autonomie de la batterie 3h
- Temps de charge 2,5h
- Typologie batterie NiMH - 2500 mAh
- Vie de la batterie (charge / décharge) 500 cycles
- Tension d'alimentation 100÷240 @ 50/60Hz
- Précis contrôle de la charge à microprocesseur
- Voyant lumineux du chargeur:
  - rouge fixe:** la lampe n'est pas insérée, ou mal insérée;
  - rouge clignotant:** lampe en recharge;
  - vert fixe:** recharge terminée. Fonction maintien de charge.

**ART. 344** – Lampe rechargeable Strip Lamp + chargeur de batterie.



STRIP LAMP: Aufladbare Handlampe mit LED

### EIGENSCHAFTEN

- Lichtquelle Strip Led
- Lichtstrom 360lm
- Schutzart IP 65
- Austauschbare durchsichtige Abdeckplatte.
- Soft-touch-Schalter (durch Schutzhülle überzogen).
- Verstellbarer Haken.
- Lebensdauer der Batterie 3h
- Ladezeit 2,5h
- Kapazität der Batterie NiMH - 2500 mAh
- Batterie Lebens Komplette Zyklen von Lade / Entlade 500
- Versorgungsspannung 100÷240 @ 50/60Hz
- Präzise Steuerung der Aufladung mit Microprocessor
- Auflader Kontrolleuchte:
- rote Dauerleuchte:** die Lampe ist nicht eingeschaltet, oder nicht gut eingeschaltet;
- rote Blinkleuchte:** die Lampe ist in Wiederaufladung;
- grüne Dauerleuchte:** Laden fertiggestellt. Funktion Ladebereitschaft.

**ART. 344** – Aufladbare Handlampe Strip Lamp + Batterielader.



STRIP LAMP: lámpara Led recargable con gran luminosidad.

### CARACTERISTICAS

- Fuente de luz Strip Led
- Flujo luminoso 360lm
- Modo de protección IP 65
- Plastico transparente sustituible.
- Interruptor blando protegido.
- Gancho orientable.
- Duración de la batería 3h
- Tiempo de carga 2,5h
- Capacidad de la batería NiMH - 2500 mAh
- Vida de la batería (carga / descarga) 500 ciclos
- Voltaje de suministro 100÷240 @ 50/60Hz
- Control preciso de la carga con microprocesador
- Indicador luminoso sobre el cargador:
- rojo fijo:** la lámpara no está insertada, o mal insertada;
- rojo parpadeante:** lámpara en recarga;
- verde fijo:** carga ultimada. Función mantenimiento de carga.

**ART. 344** – Lámpara recargable Strip Lamp + cargador.

### SPARE PARTS-PIÈCES DE RECHANGE

**ART. 344/VY** - Transparent cover/calotte transparente. 



**ART. 344/L** - Lamp/Lampe/Lampe/Lámpara. 

**ART. 344/C** - Battery charger/Chargeur/ Ladegerät/Cargador. 

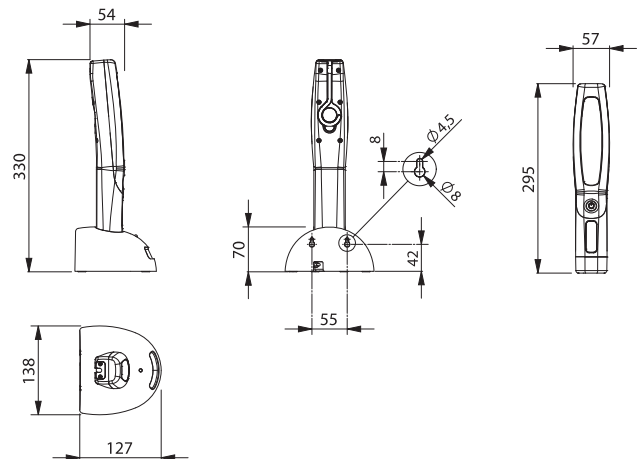
### DIMENSIONS



REGISTERED DESIGN  
PATENT PENDING

Art.	344
Description	Rechargeable and powerful led lamp
Active life Autonomie de lumière Leuchtdauer Autonomía de luz	3 h
Recharge time Temps de recharge Komplette Aufladezeit Tiempo de recarga	2,5 h
Lamp protection degree	IP65
Charger protection degree	IP20
Battery Batterie	4,8V 3300 mAh - Ni-MH
Battery charger Chargeur de batterie Batterielader Cargador	100-240V 50-60Hz 8VA
	104
	mm. 320x215x75 Kg. 1,1
	mm. 600x800x600



Manufactured according to standard:  
Construit selon norme:  
EN 60598-1 EN 60598-2-8  
EN 60335-1



These products comply with Directives:  
Produits conformes aux Directives:  
2006/95/CE 2002/95/CE  
2004/108/CE

