



IT'S QUALITY THAT PUTS THINGS INTO MOTION

Lammers is iconic for quality in all areas of electrical industrial drives. We offer a fully staged performance package with industrial drives, service & maintenance, special drives, diagnostics, on-call duties and our ground-breaking "ZOI[®] service status-oriented maintenance". This is why we have emerged as the regional market leader with more than 100 employees at our Rheine site.

A HISTORY OF QUALITY

You've got to stay in motion if you want to show the others what maximum quality is all about – especially over decades. That's been our philosophy since 1946 and that's why we expanded and broadened our expertise from the very beginning whilst regularly extending and improving our storage and workshop capacities. Just take a look at our history and you'll see what we mean.



Clemens Lammers was set up in Rheine, Germany

Moving into a new building at the Salzbergener Straße

RP Münster approves repair of explosion-proof electrical motors and operating materials

Taking over the MEZ general agency

Company moved to the North Industrial Area

Starting up a performance evaluation stand for electrical motors

Building an additional warehouse

Almost doubling our production and storage area by purchasing the neighbouring buildings

1946

1949

1971

1972

1978

1982

1985

1990

A PHILOSOPHY OF QUALITY.

Our products and services will meet all of your needs, especially in terms of quality, and economic efficiency and including environmental and occupational safety. We identify with your needs by meeting your targets timely and efficiently with expert skills and at competitive conditions.

A FUTURE OF QUALITY.

Our employees carry out every step in mechanical and electrical processes at our headquarters to keep up with the high standards of quality we set ourselves. You can rely on timely delivery, even if we're talking about special designs or modifications. Quality is our motivation for pursuing this principle today, tomorrow and in future.



Christoph Südhoff
Managing Director



Martin Mientus
Works Manager



Johannes Börgel
Head of Sales Service & Maintenance



Marco Hukriede
Head of Sales Industrial Drives

Rolling out our "ZOI® – status-oriented maintenance" strategy

Building up our performance evaluation stand

Nationally recognised as the first specialist for industrial drives

Innovation Prize of the Education and Research Ministry for components of our "ZOI® – status-oriented maintenance" strategy

Moved our entire operations to our new location at Offenbergring 17 in Rheine, Germany

Lammers Trioda Motor Kft. in Budapest, Hungary

Lammers Automation GmbH Control and Automation Engineering in Emsdetten, Germany

Adding two extra halls to our warehousing department with a total built-up area of 10,000 m²

New test field for testing performance up to 400 kW

QUALITY THAT PUTS THINGS IN MOTION TODAY AND IN THE FUTURE.

We are the largest specialist in industrial drives and the market leader in our region because quality is what triggers all of our decisions. It has been driving all our work processes since 1946. Every step, every process and all performance is stamped with the **"Q" for quality** symbol. That's why we can take on the responsibility for your production plants, products and drives. We carry out every mechanical and electrical process right at our headquarters. **This is what we call full staging.**

Our Q-four-principle:

Industrial drives, special drives, service & maintenance and diagnostics

When all four synchronise, they provide the quality we are known and respected for. They are based on third party approved certification such as ISO 9001-2008, OHSAS 18001, ATEX and marine classifications.

But that's not all. We have well-defined process ownership and streamlined processes that guarantee efficiency and effectiveness.

Beyond this, we have more than 100 highly trained experts who are perpetually trained on a regular basis. We are proud to showcase our 30,000 square meters of production site where we aim for growth and future sustainability.

All of this, enables us to put our heads together with you on an equal footing. Networking people, machines and processes independent of time and place will offer new possibilities and requirements for us.

We're ready – not only in our technology, but also in our way of thinking.

**FOUR-PRINCIPLE
INDUSTRIAL DRIVES**



**FOUR-PRINCIPLE
SPECIAL DRIVES**



**FOUR-PRINCIPLE
SERVICE & MAINTENANCE**



**FOUR-PRINCIPLE
DIAGNOSTICS**







**FOUR-PRINCIPLE
INDUSTRIAL DRIVES**

Fast response and production times with cost optimisation.

Our customers make integrate systems to come to grips with increasingly complex applications and we guarantee process continuity with a wide range of tools and proven reliability.

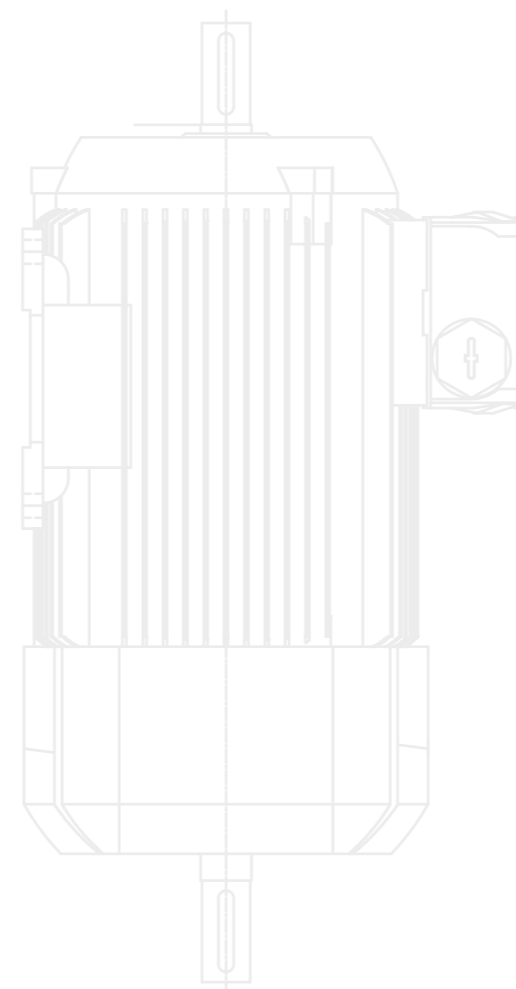
We have 10.000 square meters of warehouse storage of more than **50.000 electrical drives**. That means you can get frequency drives, gears and electric motors ex stock. Available when required. Benefit from our experience – both in person and online: call up technical data, order products, configure options and check availability.



Short-term availability:

| sizes 63–400 low-voltage motors

- "standard efficiency IE1"
- "high efficiency IE2"
- "premium efficiency IE3"
- "super-premium efficiency IE4"
- progressive sizes
- aluminium and grey cast-iron design
- protective systems IP 55, IP 56, IP 65
- IP 23 protective system
- special voltages/frequencies
- various marine classifications
- ATEX zone 1, 2, 22 and 21
- ATEX EEx-de, EEx-e
- single-speed, pole-changing and voltage-changing

| medium and high-voltage motors

| frequency converters for various protective systems

| coolant pumps

OUR COMPREHENSIVE RANGE OF SUPPLIES

We would be delighted to introduce our product portfolio. Don't forget, we're always ready to assist you in meeting complex requirements and specifications.

Low-voltage motor classes

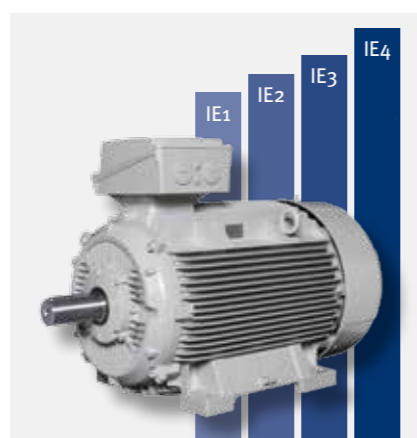

- € efficiency classes: IE1, IE2, IE3, IE4
- Ⓢ frequency: 50 Hz, 60 Hz
- ▮ numbers of poles: 2-, 4-, 6-, 8-, 10-pole (including pole changing motors)
- Ⓜ sizes: 63 – 400 in stock (including progressive sizes)
- 🛡 protective systems: IP 55, IP 56, IP 65
- 🌐 various quality assurance tests: NEMA, UL, CSA etc.
- 🌡 isolation class: F
- ⚓ approval for ship drives: certificates for DNV, GL, BV, LRS, Rina

Medium/high voltage motors

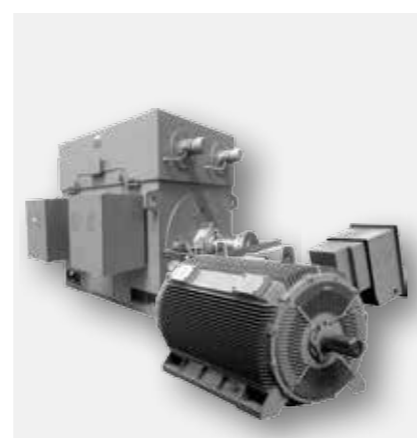

- Ⓢ frequency: 50 Hz, 60 Hz
- ⚡ rated voltage: 3 – 13,8 kV
- ⚙ output: 185 kW – 5 MW
- ▮ numbers of poles: 2-, 4-, 6-, 8-, 10-, 12-pole
- Ⓜ sizes: 315 – 630
- 🛡 protective systems: IP 55, IP 23
- 🌡 various cooling methods (IC 411, IC 01, IC 418)
- 🌡 isolation class: F

IP 23-motors



- € efficiency classes: IE2, IE3
- Ⓢ frequency: 50 Hz, 60 Hz
- ⚙ output: 11 – 710 kW
- ▮ numbers of poles: 2-, 4-, 6-pole
- Ⓜ sizes: 160 – 355
- 🛡 protective system: IP 23 (open design)
- 🌡 isolation class: F

Explosion-proof motors



- € efficiency classes: IE2, IE3
- Ⓢ frequency: 50 Hz, 60 Hz
- ▮ numbers of poles: 2-, 4-, 6-, 8-pole
- Ⓜ sizes: 63 – 315
- 🌡 isolation class: F
- 🔥 protection types: Ex e, Ex d, Ex nA, Ex tb, Ex tc



**FOUR-PRINCIPLE
SPECIAL DRIVES**

Standard designs don't always meet your needs.

Our expertise and production capacity enables us to launch complex applications right at our headquarters. Our employees will meet your demands fast by carrying out all of the mechanical and electrical processes.

That includes certificates, acceptances and no-load operation tests. **That's what we call full staging.** That's the advantage we have over "pure trade". We guarantee fast delivery times, a high level of reliability and a wide range of products with a superb technical back-up.

You don't just get a one-size fits all motor, but a specialised drive designed and produced according to your specification.

A special drive according to your particular ideas –
Special windings, extraneous ventilation attachments and a whole lot more...

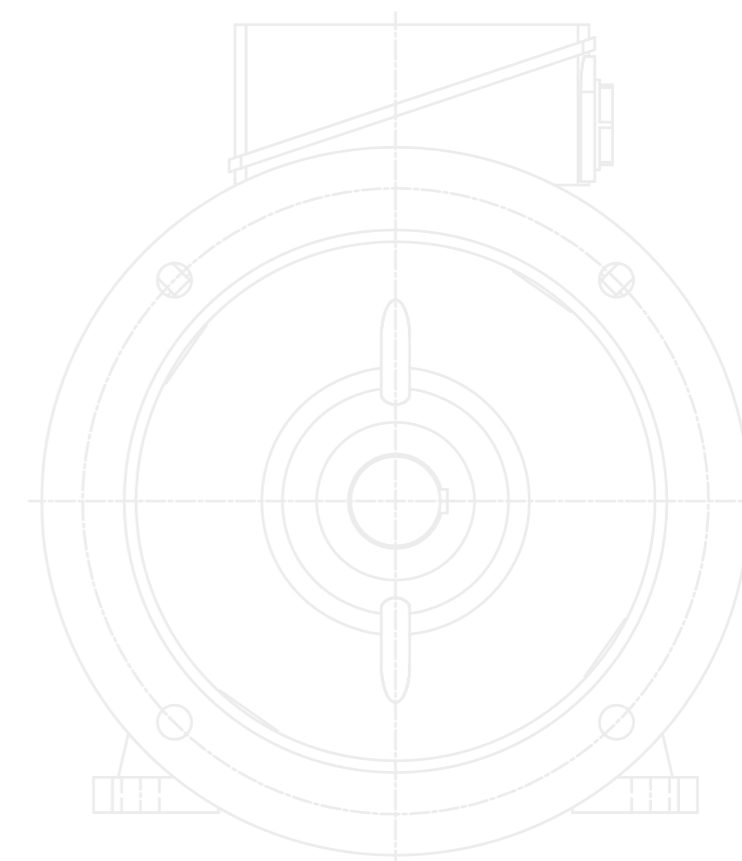



ONE MOTOR – MULTIPLE OPTIONS

Our long standing experience guarantees that you will find a solution to meet your specific needs with a high-quality drive. Impressive in efficiency and performance.



Our features:

- | special windings
- | shaft encoder mountings
- | brake mounting
- | extraneous ventilation attachments
- | special shafts
- | special lacquers
- | various insulation classes
- | built-on frequency converters
- | and a whole lot more

side terminal boxes



design cables



custom-made plugs



mounted Harting plugs



built-on frequency converters







**FOUR-PRINCIPLE
SERVICE & MAINTENANCE**

Your production systems are the most important thing to us.

We go beyond everyday maintenance with you by providing holistic state-of-the-art maintenance strategies by the interaction of service, maintenance and repair.

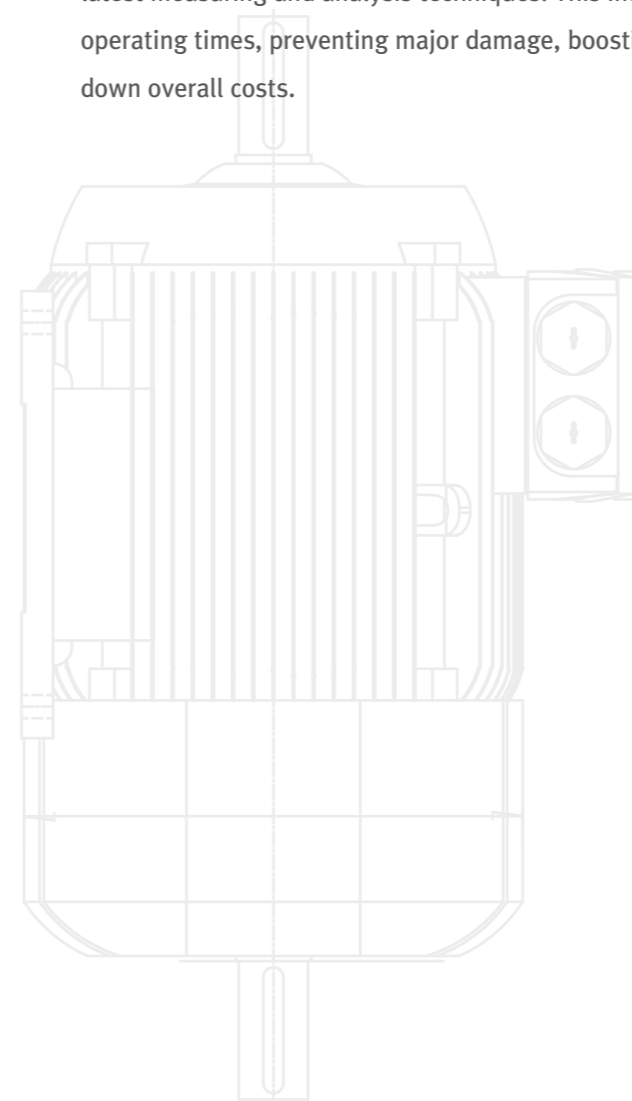
Our "ZOI[®]– StatusOriented maintenance" minimises the risk of malfunctions. We prevent unscheduled machine breakdowns with a logical combination of the latest measuring and analysis techniques. This includes service work outside of operating times, preventing major damage, boosting running times and driving down overall costs.



The focus of our machines:

- | asynchronous, direct-current and servomotors
- | synchronous, asynchronous and direct-current generators
- | gear motors
- | pumps
- | compressors
- | fans
- | licensed for repair of ex-protected EEx-e and EEx-d motors
- | crane systems and transporting equipment
- | stator-rotors
- | frequency converters and controls
- | transformers

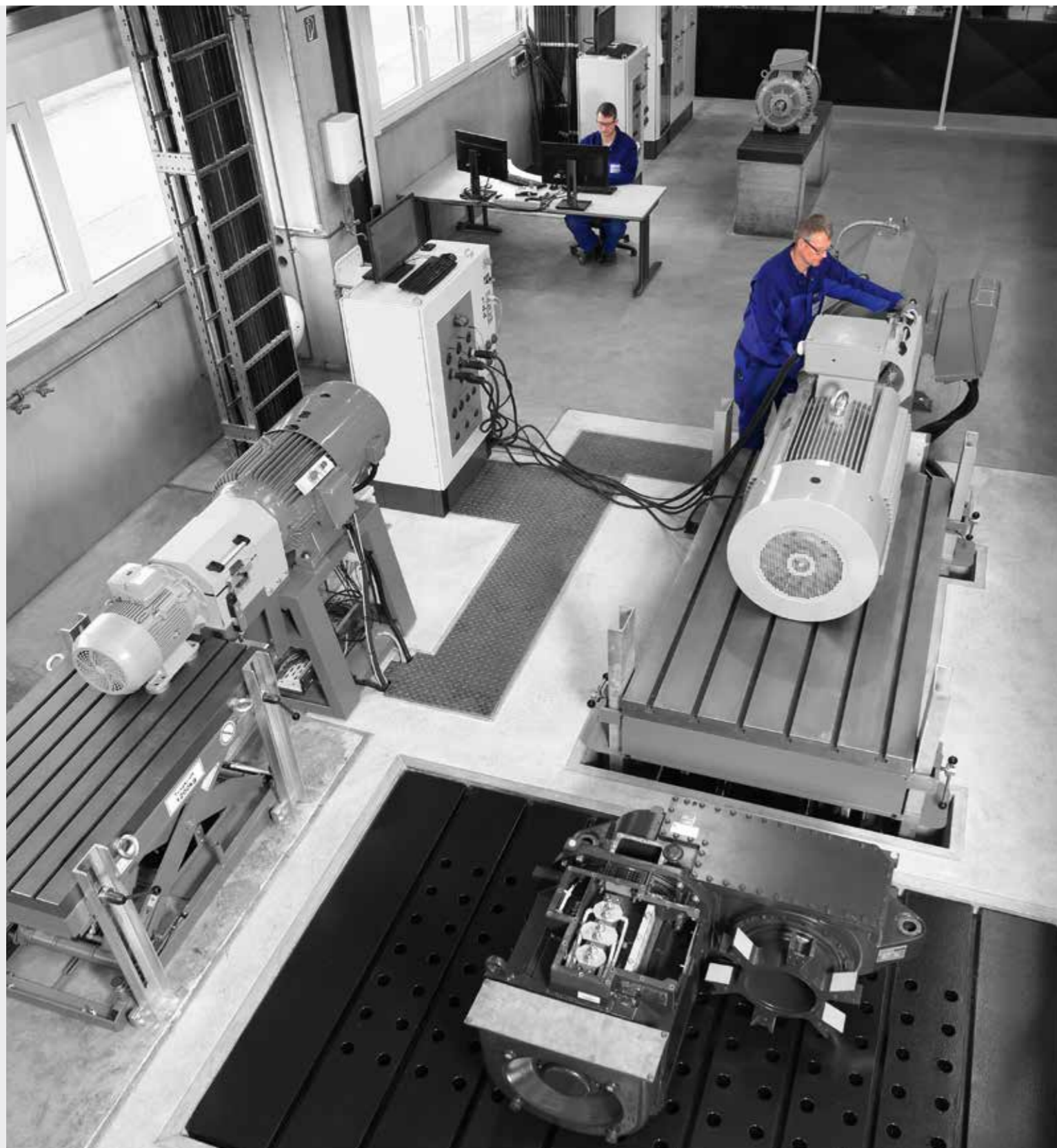

There's no way to rule out malfunctions. That's why you can always rely on us.

That includes 24-hour electrical response service.



One reason is the fact that the complexity of a breakdown as well as the best possible solution can only be assessed in site. Our qualified employees are continually trained to enable them to make decisions in on-site maintenance or at our headquarters.

*Networked & totally digital
performance testing up to
400 kw*

*In the foreground:
disassembling a traction
motor for train vehicles*

*In the background:
assembling synchronous
servomotors*

Our tools:

- | test stands for AC and DC motors, generators, servomotors, etc.
- | load tests up to 400 kW
- | analysis processes for frequency and oscillation
- | thermographic systems
- | parallel network operation of synchronous generators
- | surge voltage tests
- | laser-optic alignment systems
- | rotary, milling and balancing to 6t
- | lifting, disassembly and assembly equipment to 20t





**FOUR-PRINCIPLE
DIAGNOSTICS**

Reliable data and dependable information are what count when things get tricky.

Decades of experience – state-of-the-art measuring techniques – reliable analyses ensures reliable reporting. **That's how we define diagnostics.**

Our comprehensive and state-of-the-art measuring techniques, in-house test field and qualified employees enable us to give you a meaningful and reliable understanding of the situation. We give you the answers you need for solving difficult problems in electrical industrial drives.

"ZOI® – StatusOriented maintenance" consists of a holistic analysis of your systems

Problem-solving capability with comprehensive diagnostics:

- | frequency and oscillation analyses
- | thermography
- | laser-optic alignment systems
- | analyses of winding systems
- | mobile balancing
- | measuring belt tension
- | surge voltage tests to 24 kV



On site for you
We come up with tailor-made and efficient maintenance systems



Maximising production times thanks to "ZOI"[®]

We have been analysing the right time for maintenance work with our "ZOI[®] – status-oriented maintenance" system at your site for many years for keeping scheduled and unscheduled downtimes to a minimum.

Our holistic analysis of your plants offers you individualised and efficient maintenance cycles by supplying the key data for utilisation intensity at specific loads and for the right maintenance times.

Our proactive machine performance management takes advantage of regular measuring rounds to maximise machine running times and minimise overall costs. This is how you reduce the risk of malfunctions in your production, boost plannability of expenditures, avoid downstream damage and get reliable statements on the remaining running time.

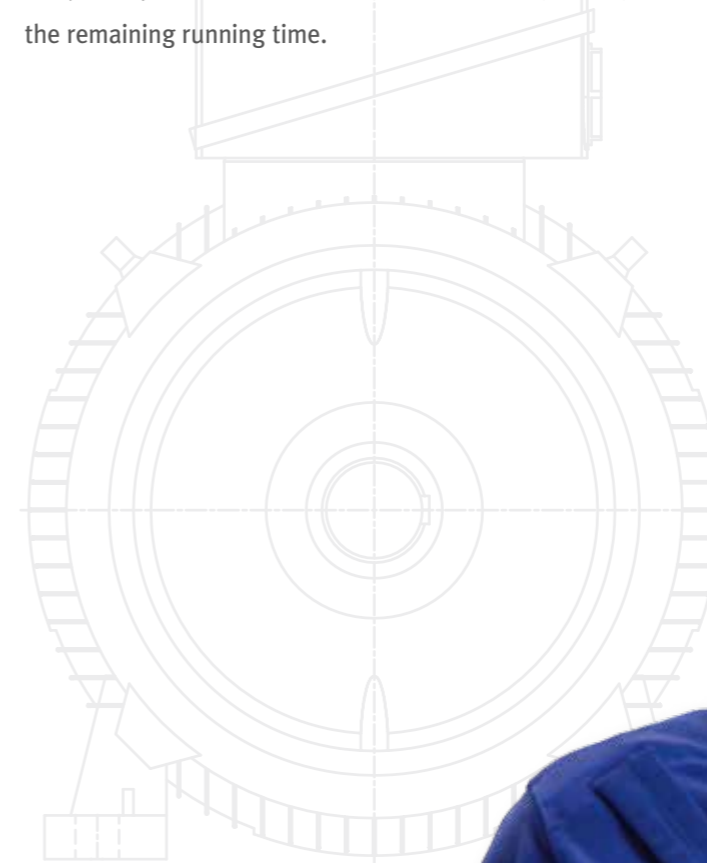

*"We live and breathe
fair and open dealings
with one another"*



QUALITY IN THE GROUP

Quality is the principle that the Lammers Group lives and breathes – transborder synergies, varying markets and exchanging expertise while utilising a whole range of knowledge.



Clemens Lammers GmbH & Co. KG
D-Rheine
www.lammers.de



Lammers Automation GmbH
D-Emsdetten
www.lammers-automation.de



Lammers Trioda Motor Kft.
H-Budapest
www.lammers-trioda.hu

CERTIFICATIONS

ISO 9001:2008

OHSAS 18001:2007

ATEX Zone 1, 2, 21, 22



Marine classification:

Bureau Veritas

Rina 1861

DNV GL

Lloyd's Register





Clemens Lammers GmbH & Co. KG

Offenbergweg 17 | 48432 Rheine | Germany

Phone: 0049 (0) 5971 8011-0

Fax: 0049 (0) 5971 8011-4011

Email: info@lammers.de | Web: www.lammers.de