

DF-3/DF-3+

MEDIUM VOLTAGE SWITCHGEAR

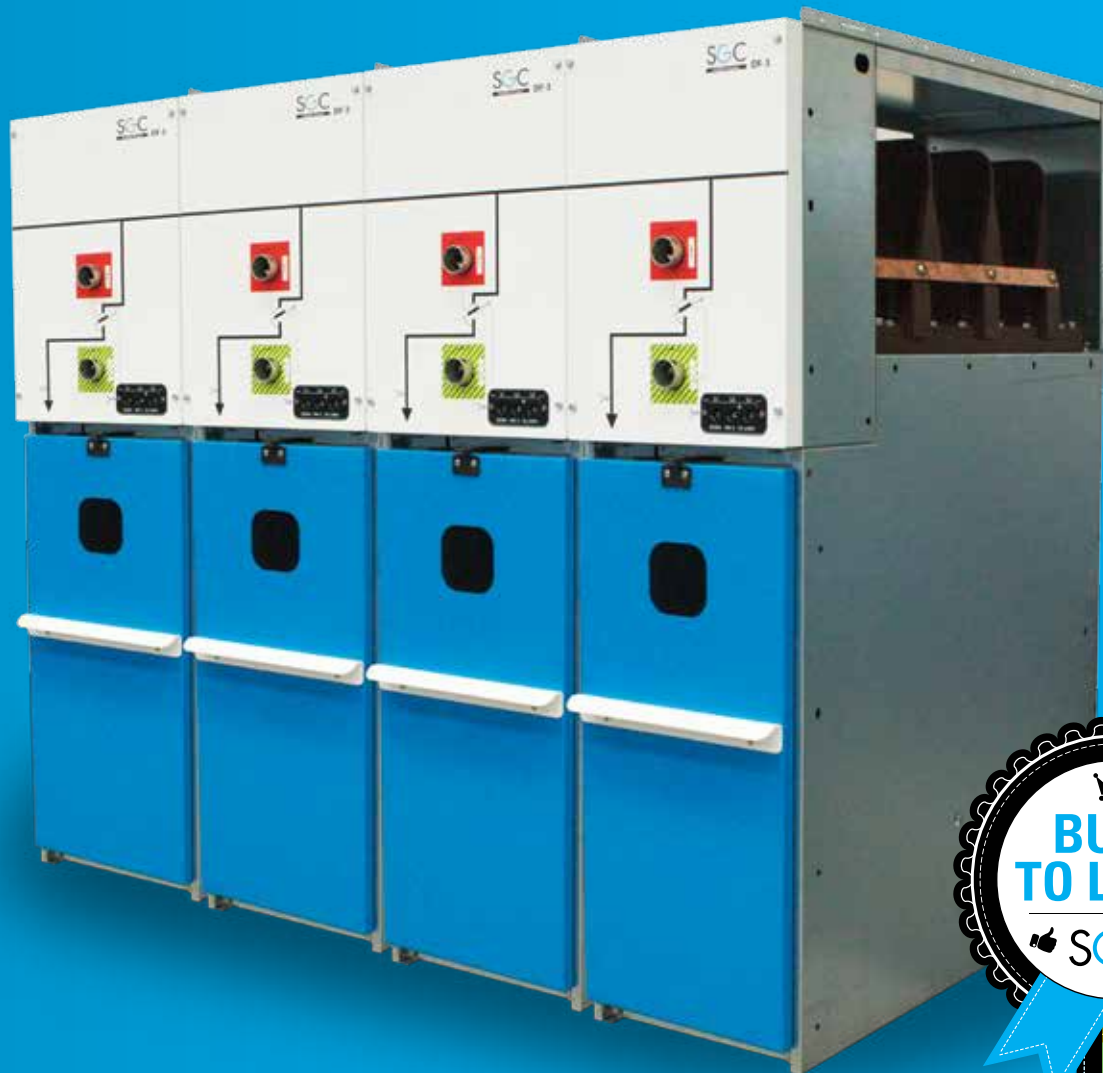

DF-3, a modular concept combining all medium-voltage functions.

DF-3'S MODULAR DESIGN ALLOWS YOU TO CREATE RATIONAL, ECONOMICAL & CUSTOM-MADE COMBINATIONS OF MEDIUM-VOLTAGE CUBICLES (WITH A RATED VOLTAGE OF 12, 17,5 OR 24 KV)

SGC

SwitchGear Company

THE SPECIALIST IN MEDIUM VOLTAGE SWITCHGEAR

www.switchgearcompany.eu - info@switchgearcompany.eu

TABLE OF CONTENTS

1. OVERVIEW	p. 3
1.1. DF-3 DESIGN PHILOSOPHY AND APPLICATIONS.....	p. 3
1.2. MODULAR TYPE DF-3.....	p. 3
1.3. APPLICATION.....	p. 4
1.4. SF ₆ INSULATION.....	p. 6
1.5. STANDARDS.....	p. 6
1.6. INTERNAL ARC RESISTANCE.....	p. 7
1.7. DF-3+ OPTION WITH BUILT-IN ARC-KILLER SV-53.....	p. 8
2. COMPARTMENTS	p. 9
2.1. SWITCHGEAR COMPARTMENT.....	p. 9
2.2. BUSBAR COMPARTMENT.....	p. 9
2.3. CABLE COMPARTMENT.....	p. 9
2.4. LOW-VOLTAGE COMPARTMENT.....	p. 9
3. DF-3 MODULES RANGE	p. 10
3.1. TECHNICAL SPECIFICATIONS.....	p. 10
3.2. EXTENSIVE SPECIFICATIONS.....	p. 11
3.3. MODULES - SPECIFICATIONS & DIMENSIONS.....	p. 12
• DF-A.....	p. 14
• DF-A+.....	p. 15
• DF-P.....	p. 16
• DF-D.....	p. 17
• DF-C-750.....	p. 18
• DF-K.....	p. 19
4. PRODUCTION PROCESS	p. 20
4.1. PRODUCTION PROCESS OF THE DF-3 CUBICLES IN NEVELE.....	p. 20
5. OTHER PRODUCTS BY SGC - SWITCHGEAR COMPANY	p. 22



SGC - SwitchGear Company • Moorstraat 24 • B-9850 Nevele • Belgium
 Tel. +32 (0)9 321 91 12 • Fax. +32 (0)9 321 91 13 • Internet: www.switchgearcompany.eu • E-mail: info@switchgearcompany.eu

1. OVERVIEW

1.1. DF-3 DESIGN PHILOSOPHY AND APPLICATIONS

SGC - SwitchGear Company is a fast-growing Belgian company that invests considerable time and energy in Research & Development to serve customers even better.



User-friendliness, safety and care for the environment were the main drive for developing SGC - SwitchGear Company's switchgear.

Over time SGC - SwitchGear Company has developed the "DF-3", a modular concept which combines all medium-voltage functions. It allows SGC - SwitchGear Company to provide "made-to-measure" solutions for all your medium-voltage needs.

The DF-3 cubicles and associated switchgear offer a wide range of applications and can be used worldwide in many industries. DF-3 cubicles can be used with distribution and dispersion switchgear, electrical substations and medium-voltage engines, wind generators, cogeneration, and much more.

The DF-3-concept provides a solution for all your needs and demands: it can replace obsolete installations and extend existing installations, and it is also perfectly suitable for entirely new constructions.



1.2. MODULAR TYPE DF-3

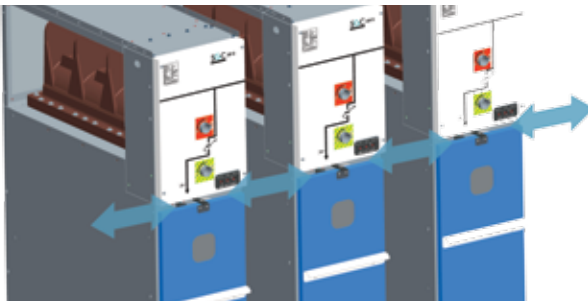

The DF-3 system is a modular concept based on the "building blocks" principle, which means that cubicles are produced in series. As a result, the modular DF-3 concept meets the highest technical standards in a rational, economically sound way. The combination of cubicles is unlimited. Very complex diagrams of distribution and transformer switchgear can be compiled through this extensive spectrum of possibilities.

The cubicle dimensions are very dense since the switching occurs in an SF₆ insulation medium. The semi-compact cubicles are particularly beneficial if the available

space should pose a problem or if economical factors play an important role.

Cubicles also contain all functional interlocks which allows for effortless application, according to all current standards, and which allows installation in consumer work spaces. As a result, capacity loss will be minimal. Additionally, the cubicles have been fitted with a system for pressure release which shields the user from the consequences of an internal arc.

"A modular concept combining all medium voltage functions..."

1.3. APPLICATION

Power stations generate electrical power, with voltages up to 380.000 V, which is transported to transformer stations and dispersion stations.

These substations distribute medium voltage (+/- 3 kV to +/- 24 kV). Here too, a number of SGC - SwitchGear Company's cubicles are used. A medium-voltage grid starts from every substation and supplies a large area with medium-voltage.

Wherever medium-voltage enters residential areas, industrial production companies, market gardening, hotels, sport venues, and more, there is a medium-voltage cubicle fulfilling four essential functions.

1. **POWER SUPPLY:** the network distributor's grid is branched off to allow switching.
2. **SECURITY:** the installation is secured with a load break switch with HRC fuses, or by a circuit breaker with a protection relay.
3. **MEASUREMENT:** the energy consumption is measured on the high-voltage, or low-voltage side.
4. **TRANSFORMATION:** medium-voltage is transformed into low-voltage (690 V-400 V-231 V).

"SGC provides made-to-measure solutions for all your medium-voltage needs"

The Power

CO-GENERATION MARKET GARDENING

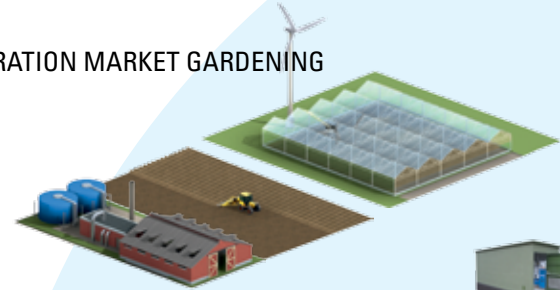

CATERING INDUSTRY / SHOPPING CENTER

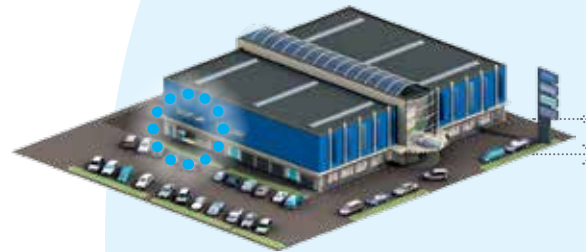

INFRASTRUCTURE



RESIDENTIAL AREAS



Grid...

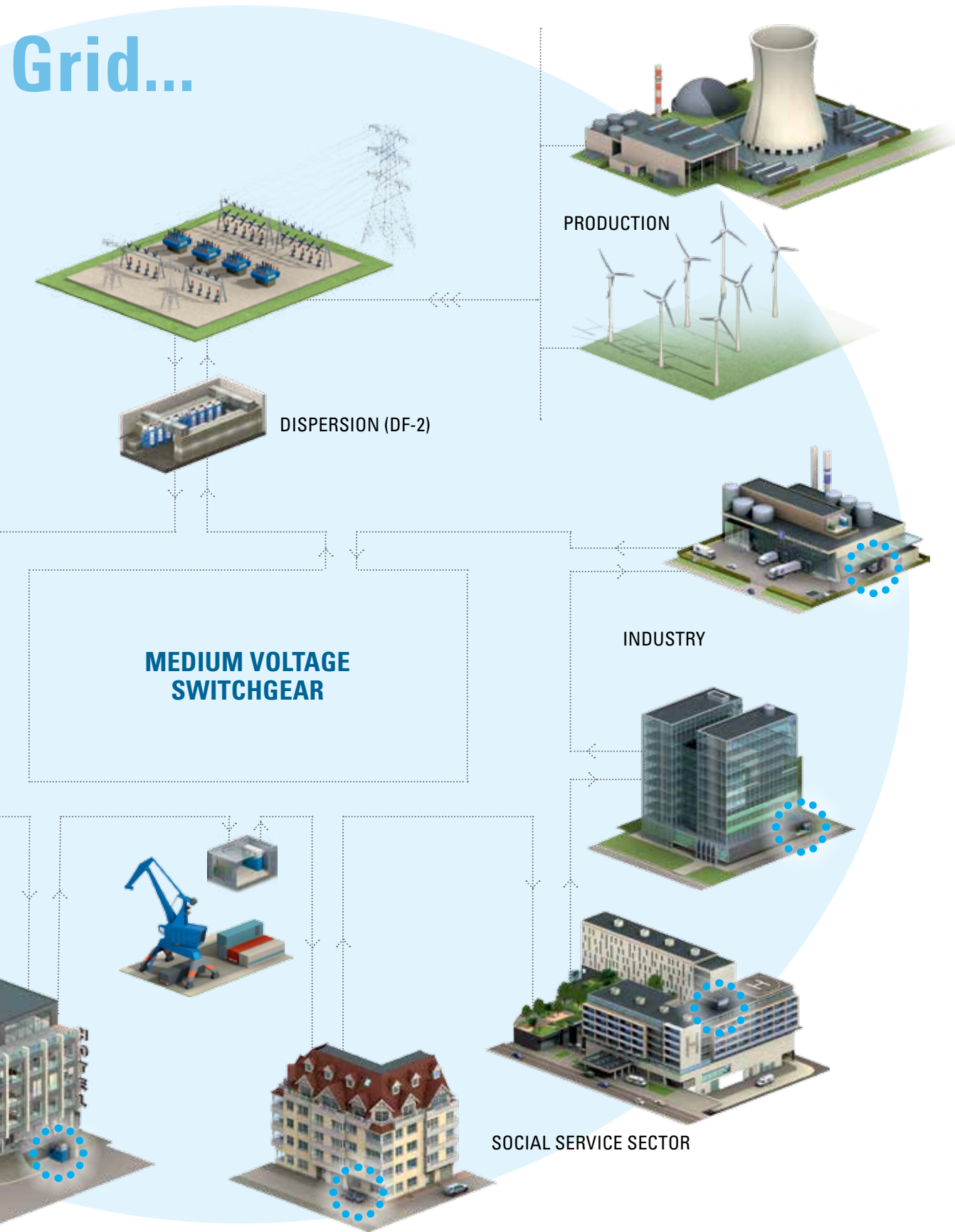

1.4. SF₆ INSULATION

SF₆ stands for sulphur hexafluoride, which is a clear and odourless, inert, non-toxic and nonflammable gas. It is extremely stable, especially due to the six covalent connections of the molecule. SF₆ has a molecular mass of 146.05, 5 times heavier than air, which makes it one of the heaviest gasses. It can be obtained in cylinders anywhere in the world and is used extensively in different sectors such as the petrochemical field, the nuclear sector, and in electron microscopy. SF₆ is even found in double glazing.

For over 30 years SF₆ gas has proven to be superior as an insulation and interruption medium in high (HV) and medium-voltage (MV) installations. One of the physical characteristics of SF₆ is that the gas neutralises electrons. Its insulating property makes SF₆ especially important for medium and high-voltage switchgear, switches and transformers.

In MV and HV installations, it is extremely important that the cables and switchgear are well insulated to avoid electrical arcs or short-circuits. There is even an additional advantage: SF₆ gas acts as a space saver since it requires less space than air for switching purposes.

SGC - SwitchGear Company's RV53 load break switch is filled with SF₆ gas. Switches are "sealed for life" and require minimal maintenance. When it comes to recycling electrical components, current regulations require recuperation of components containing gas after their lifecycle ends. The recuperation of SF₆ products is regulated by law and executed by specialized companies according to a strict schedule. SGC - SwitchGear Company will be available at all times to help you with this specific problem.



1.5. STANDARDS

The DF-3 system has been certified according to IEC (International Electrotechnical Commission) standards:

The whole concept conforms to ISO procedures, certificates and even to ISO 9001 guidelines. Cubicle testing is carried out in accordance with IEC regulation and self-enforced quality requirements.

"All cubicles are built according to IEC 62271-200"



1.6. INTERNAL ARC RESISTANCE

A short-circuit or another malfunction can create an internal arc. An internal arc in a classic MV cubicle, could severely damage the installation and possibly injure the operator and electrocute him or her.

The DF-3 is designed to resist internal arcs, protecting both the operator and the installation. Through a strategic **pressure release system**, the internal arc is restricted to the compartment where it originated and it does not propagate towards the operator or to other compartments.

The anti-arc kit of DF-3 cubicles is specifically designed to minimize the consequences of an internal arc. By default all provided cubicles are fitted on the rear side with overpressure valves pointing downward.

The three valves are evenly spaced among the total height of the cubicles: The upper valve is for the busbar and the two other valves protect both the cable compartment and the equipment compartment.

Upon delivery, two reinforced side plates will be supplied in order to close the cabin completely, both to the left and right sides against the wall. As a result, an expansion space is created across the total height and width of the installation.

For applications in accessible concrete outdoor cabins, the anti-arc kit allows gasses to be diverted to the basement area. There is an exhaust opening in the floor panel along the side of the wall specifically for this purpose.

DF-3 cubicles were **tested with these specifications at independent, accredited testing stations (e.g. IPH, Kema)**. All components were subjected to an internal arc test IAC 14kA - 1s. All IEC 62271-200 (2003-11) assessment criteria have been met.

The load break switch RV53 was tested according to IEC 62271-200 (2003-11)/class E3. **Consequently, all SGC - SwitchGear Company cubicles are internal arc resistant.**



When conducting the various tests the cubicles were always set up "trihedral shockproof" in accordance with the conditions.

1.7. DF-3+ OPTION WITH BUILT-IN ARC-KILLER SV-53

Protect your cubicles, your infrastructure, and especially your staff against the negative consequences of an internal arc. The built-in arc-killer extinguishes an arc in less than 50 ms.

The DF-3+ includes the arc-killer SV-53, a system for detecting and extinguishing an internal arc. The arc-killer extinguishes the arc by directing it to a metal earthed short circuit. The arc is extinguished in less than 50 ms.



*KEMA type tested according to IAC: B, FLR 20 kA 1 s.
This solution is patented.*

“The built-in arc-killer extinguishes an arc in less than 50 ms.”

A DF-3+ is a metal-enclosed cubicle of the DF-3 type combined with a shaft at the rear of the cubicle. The shaft absorbs the gasses (in case of an internal arc) that escape through the overpressure valves. **As a result, the expansion of hot gasses in a room can be reduced to an absolute minimum.** DF-3+ type cubicles offer protection against an internal arc classification IAC category B, FLR 20 kA 1 s. (F=frontal, L=lateral, R=rear)

As a result, the operator is protected against the negative consequences of an arc, whether they stand in front of the switchboard, next to it or behind it.



SGC - SwitchGear Company's patented SV-53 Arc-Killer takes **safety to a new level**. Not just the operator and the environment are shielded from harm, but the super-swift arc extinguishing system allows cubicles to be back in operation very quickly in case of an internal fault. What's more, **the arc-killer's improved security features place less strict demands on the installation room**. As such, the Arc-Killer couples security and operational safety, with flexible room demands.

2. COMPARTMENTS

2.1. SWITCHGEAR COMPARTMENT

In this compartment, the SF₆-filled RV53 triple position load break switch of the “sealed for life” type, acts as the physical separation between the busbar set and the cable compartment. The switch has three functions: it connects or interrupts the electrical current between the high voltage cables and the busbar. Additionally, the earthing switch is integrated.

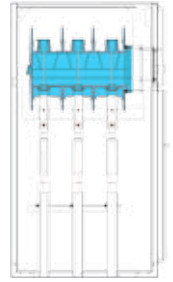

2.2. BUSBAR COMPARTMENT

The busbar compartment is located in the upper part of the cubicle and behind the low-voltage compartment. The modular busbar set is manufactured from specially provided electrolyte F25 copper Ø27mm ($I_{rBB}=630$ A). Various cubicles are connected through busbar compartments. Hexagonal bolts connect the busbars to the upper contact surfaces of the RV53 load break switch.

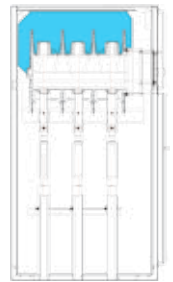

2.3. CABLE COMPARTMENT

The cable compartment is located behind the interlocked, removable door of the DF-3 cubicle. This part of the cubicle accommodates the cable(s) and contains the necessary equipment to connect the cable(s). In a DF-A cubicle, the cables are connected to the contact points below the RV53 load break switch. The cables of the DF-P cubicles are connected to the lower fuse base side. This type of cubicle also has an additional auxiliary earthing switch to divert any residual current. DF-D types have the earthing located in the cable compartment below the circuit breaker. The removable door, the sectional floor panels, which house the necessary conductive rubber for the cables, and the cable supports, all simplify the cable connection.

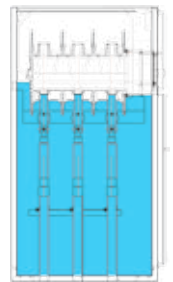

2.4. LOW-VOLTAGE COMPARTMENT

The drive mechanism that controls the RV53 load break switch and the integrated earthing switch is fitted with the synoptic diagram and is located behind the front panel. Several accessories, such as the auxiliary contacts, switch-on or switch-off coils, and minimum voltage relays, are also located in this compartment. An optional motorized drive mechanism with all the necessary control elements could also be installed in this compartment. The compartment can be accessed very easily by disassembling the front panel. Optional padlocks prevent unauthorised access.

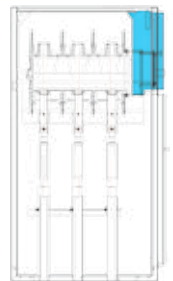

3. DF-3 MODULES RANGE

3.1. TECHNICAL SPECIFICATIONS

Rated Voltage	kV	12	17,5	24
Impulse withstand voltage 1.2 / 50 μ s				
- To earth and between phases	kV	75	95	125
- Over the insulated distance	kV	85	110	145
Power frequency withstand voltage:				
- To earth and between phases	kV	28	38	50
- Over the insulated distance	kV	32	45	60
Rated frequency	Hz	50/60	50/60	50/60
Rated current	A	630	630	630
Rated short-time current 1 s.	kA	20	20	20
Rated peak value of the current	k \hat{A}	50	50	50
Breaking capacity RV53 (Class E3)				
- Mainly active load current (I_1 / I_{loop})	A	630	630	630
- Closed loop current (I_{2A} / I_{loop})	A	630	630	630
- Cable charging current (I_{4A} / I_{CC})	A	16	16	16
($0,2-0,4 I_{4A} / 0,1-0,4 I_{CC}$)	A	5	5	5
- Short circuit making current (I_{na})	k \hat{A}	50	50	50
- Earth fault current (I_{6a} / I_{ef1})	A	100	100	100
- Cable and line charging current under earth faults (I_{6b} / I_{ef2})	A	30	30	30
Degree of protection		IP4X		
Mechanical durability c/o		1000		
Standards	IEC 62271-100, IEC 62271-1, 62271-102, -103, -105, 62271-200 and IEC 61243-5			
Certificates	KEMA/IPH			



3.2. EXTENSIVE SPECIFICATIONS

Cubicles consist of galvanized steel plates. Due to the unique design, the cubicles are able to withstand internal arcs effortlessly, both in the cable compartment as well as in the busbar compartment.

A lot of detail went into the functional design to ensure that, in the event of an internal malfunction, no bursts of flames can move between plating surfaces, the door or between cubicles.

Possible internal arcs are also guaranteed to be restricted to the compartment where they originated. The roof of the cubicle can be easily dismantled to provide smooth access to the busbar during installation and/or maintenance activities.

The copper busbar is manufactured to resist the current, which results in minimum heating at the contact points. The user-friendly construction of the drive mechanisms easily allows for optional features to be installed at a later stage. Optional features can even be installed without taking the cubicle out of service.

SGC - SwitchGear Company's countless years of experience resulted in a cable compartment as comfortable and as functional as possible. Thanks to the removable door, the operator has maximum access to the connection points. This is crucial when (dis)assembling cables and fuses, and during maintenance work. Moreover, it will save time and lead to less industrial accidents.

All connection points and fuse holders have been manufactured from rounded materials to make connecting parts as easy and as safe as possible.

Cable supports are provided to support the high voltage cable in every type of cubicle. The distance between the contact point and the cable support ensures installation of the terminals in the cubicle.

Manual operation of the cubicles requires minimal switch force. The clean and neat synoptic diagram provides a clear and safe overview of the different positions of the various parts of the cubicle.

The accessories (such as floor panels and busbars) are stored in boxes and ensure easy assembling of the cubicles. The cubicles and their corresponding parts can be equipped with a wide range of optional features on request, in order to offer expert solutions to your needs.



“The cubicles can be equipped with a wide range of optional features...”



OTHER OPTIONS & DIMENSIONS?
Please consult us for options and dimensions other than those mentioned in this catalogue.

3.3. DF-3 MODULES - SPECIFICATIONS & DIMENSIONS

DF-A

Incoming cubicle or cable field with load break switch RV53 and interlocked earthing switch.

p. 14

DF-A+

DF-A with arc-killer and shaft.

p. 15

DF-P

Transformer protection cubicle with load break switch/fuse combination.

p. 16

DF-D

Protection cubicle for auxiliary voltage feeding or network survey.

p. 17

DF-C-750

Metering cubicle.

p. 18

DF-K

Cable cubicle and/or rail shaft.

p. 19





DF-A

Incoming cubicle or cable field with load break switch RV53 and interlocked earthing switch.

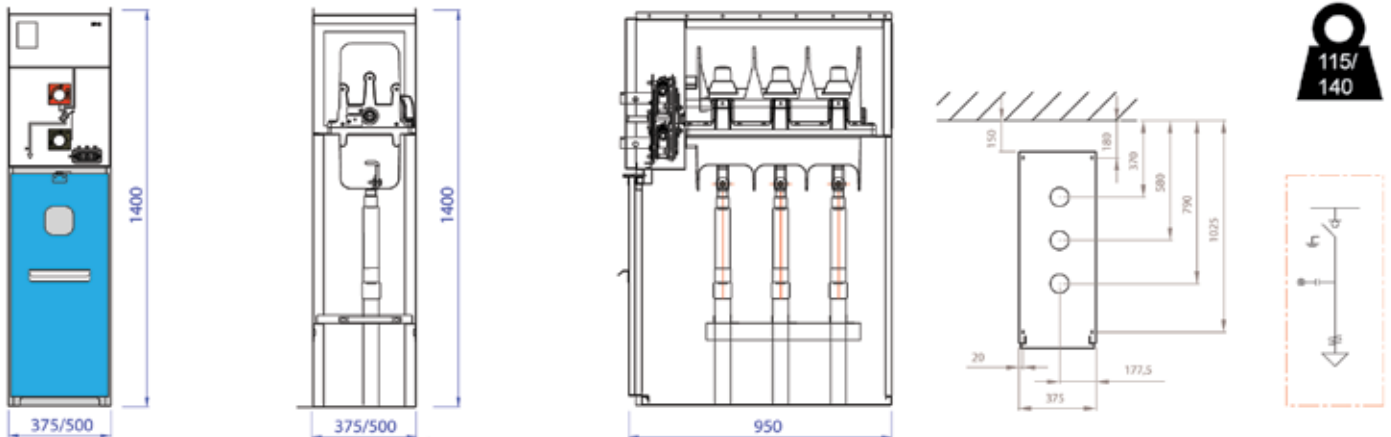

Standard Equipment

- Triple-phase load break switch RV53, class E3 according to IEC 62271-103, SF₆-insulation
- Integrated interlocked earthing switch with making capacity up to 50 kA
- Cable support
- Door interlock
- Sockets for capacitive voltage detector with parallel testing possibility
- Low-voltage compartment

Options

- Set of auxiliary contacts on load break switch
- Set of auxiliary contacts on earthing switch
- Key interlock on load break switch
- Key interlock on earthing switch
- Key interlock on both
- No door interlock
- Motor operation: 24-48-110 V - DC of 110-220 V AC
- Short-circuit indicator (to be specified by the customer when the order is placed)
- Voltage indicators
- Cubicle base: 200 mm, 300 mm or 400 mm height (Other dimensions on request)
- Floor panels
- Button press control
- Remote control

APPLICATION

Supply cable connection.

SPECIFICATIONS & DIMENSIONS

Rated Voltage	kV	12	17,5	24
Rated current	A	630	630	630
Short-term current	kA	20	20	20
Time of the short duration of current	s	1	1	1
Width	mm	375/500	375/500	500
Depth	mm	950	950	950
Height	mm	1400	1400	1400
Height between ground and end socket	mm	790	790	790
Height between ground and cable support	mm	310	310	310
Weight	kg	115/140	115/140	140
IAC AFL		14 kA - 1s		



DF-A+

DF-A with arc-killer and shaft.

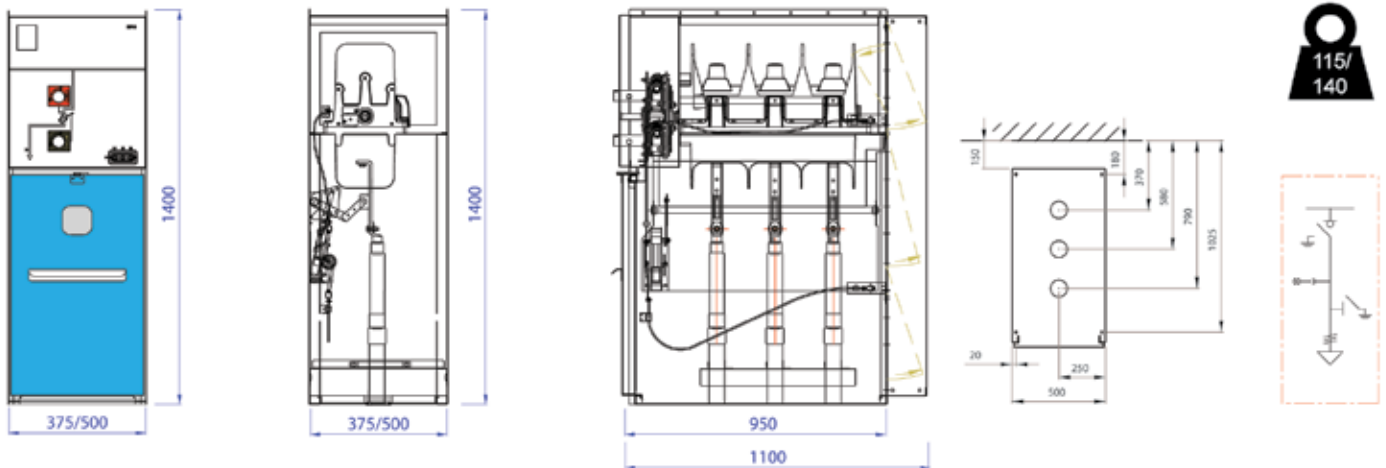

Standard Equipment

- Triple-phase load break switch RV53, class E3 according to IEC 62271-103, SF₆-insulation
- Integrated interlocked earthing switch with making capacity up to 50 kA
- Cable support
- Door interlock
- Sockets for capacitive voltage detector with parallel testing possibility
- Low-voltage compartment
- Arc-killer SV-53 built-in
- Shaft at rear of the cubicle

Options

- Set of auxiliary contacts on load break switch
- Set of auxiliary contacts on earthing switch
- Key interlock on load break switch
- Key interlock on earthing switch
- Key interlock on both
- No door interlock
- Motor operation: 24-48-110 V - DC of 110-220 V AC
- Short-circuit indicator (to be specified by the customer when the order is placed)
- Voltage indicators
- Cubicle base 200 mm, 300 mm or 400 mm height (Other dimensions on request)
- Floor panels
- Button press control
- Remote control

APPLICATION

Supply cable connection.

SPECIFICATIONS & DIMENSIONS

Rated Voltage	kV	12	17,5
Rated current	A	630	630
Short-term current	kA	20	20
Time of the short duration of current	s	1	1
Width	mm	375/500	375/500
Depth	mm	950	950
Height	mm	1400	1400
Height between ground and end socket	mm	760	760
Height between ground and cable support	mm	310	310
Weight	kg	115/140	115/140
IAC BFLR		20 kA -1s	

OTHER OPTIONS & DIMENSIONS?

Please consult us for options and dimensions other than those mentioned in this catalogue.

DF-P

Transformer protection cubicle with load break switch/fuse combination.

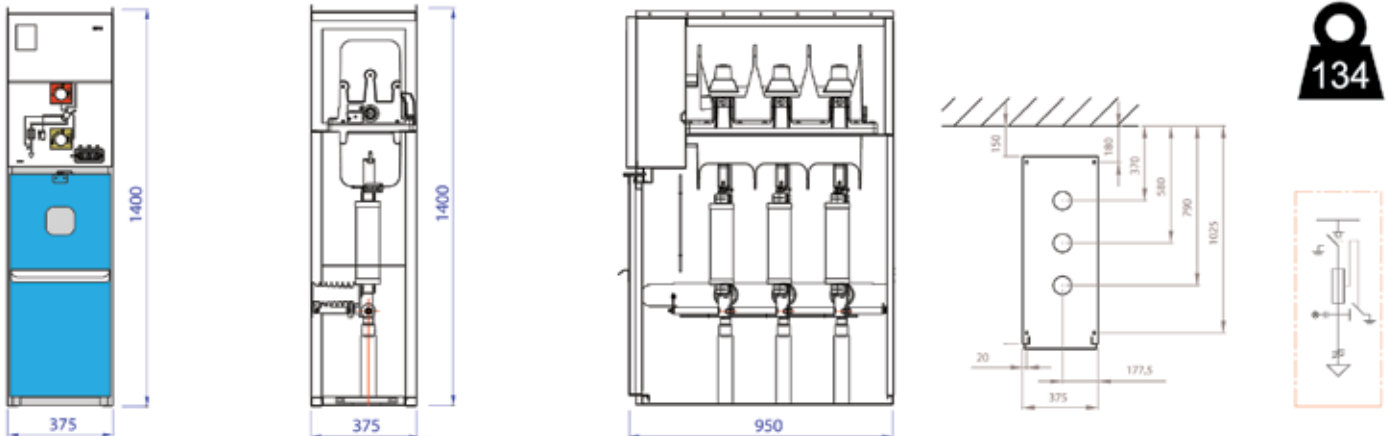

Standard Equipment

- Triple-phase load break switch RV53, class E3 according to IEC 62271-105, SF₆-insulation
- Double earthing switch with mutual interlock
- Socket for HRC fuses:
 - e = 292 mm DIN 10 at 17.5 kV
 - UTE
- Door interlock
- Sockets for capacitive voltage detector
- Low-voltage compartment
- Three phase tripping in case of fuse trip

Options

- Set of auxiliary contacts on load break switch
- Set of auxiliary contacts on earthing switch
- Key interlock on load break switch
- Key interlock on the earthing switch
- Key interlock on both
- Shunt trip *
- Under voltage release *
- Closing release *
- Motor operation *
- HRC fuses and/or spare fuses
- Contact "fuse blown"
- Automatic recloser
- Set of 2 or 3 voltage transformers
- Voltage indicators
- Cubicle base: 200 mm, 300 mm or 400 mm height (other dimensions on demand)
- Floor panels
- Button press control
- Remote control

* available voltages: 24 V AC/DC, 48 V AC/DC, 110 V AC/DC, 220 V AC

APPLICATION

Transformer protection and MV-equipment protection.

SPECIFICATIONS & DIMENSIONS

Rated Voltage	kV	12	17,5	24
Rated current	A	630	630	630
Short-term current	kA	20	20	20
Time of the short duration of current	s	1	1	1
Width	mm	375/500	375/500	500
Depth	mm	950	950	950
Height	mm	1400	1400	1400
Height between ground and end socket	mm	330	330	330
Fuse size	mm	292 (DIN)	292 (DIN)	292 (DIN)
Weight	kg	134	134	134

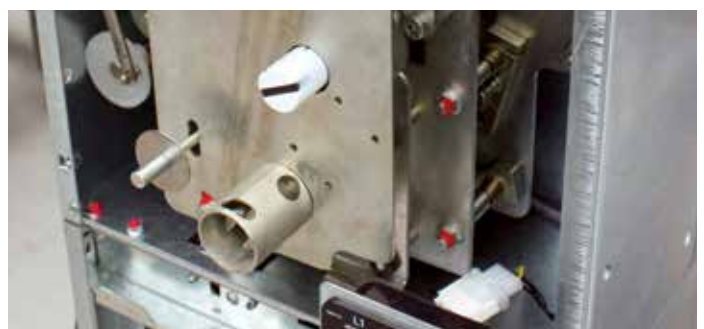

DF-D

Protection cubicle with vacuum circuit breaker with integrated protection relay.

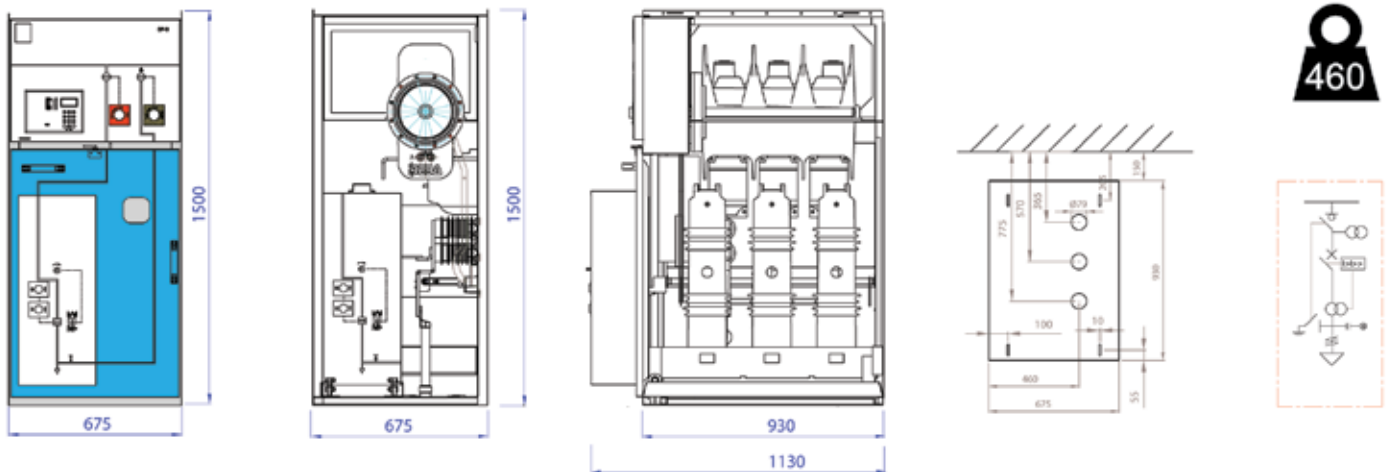

Standard Equipment

- Triple-phase load break switch RV44, class E3 according to IEC 62271-103, SF₆-insulation
- Vacuum circuit breaker with integrated protection relay, current transformers and open release
- Interlocked earthing switch with rated making capacity up to 63 kA downstream of the capacity switch
- Cable support
- Door interlock
- Sockets for capacitive voltage detector
- Voltage indicators
- LV compartment

Cubicle Options

- Set of auxiliary contacts on the load break switch
- Set of auxiliary contacts on the earthing switch
- Key interlock on load break switch
- Key interlock on earthing switch
- Key interlock on both
- No door interlock
- Motor operation on load break switch: 24-48-110 V AC/DC & 220 V AC
- Short-circuit indicator (to be specified by the customer)
- Earthing connections upwards from the circuit breaker
- Circuit breaker SF₆ insulated
- Voltage indicators
- Cubicle base: 200 mm, 300 mm or 400 mm height (other dimensions on demand)
- Floor panels
- Button press control on switch-disconnector
- Remote control on switch-disconnector

APPLICATION

Protection of descending feeders with circuit breaker, transformer and MV-equipment protection.

SPECIFICATIONS & DIMENSIONS

Rated Voltage	kV	12	17,5	24
Rated current	A	630	630	630
Short-term current	kA	20	20	20
Time of the short duration of current	s	1	1	1
Width	mm	675	675	675
Depth	mm	950	950	950
Height	mm	1500	1500	1500
Height between ground and socket	mm	360	360	360
Weight	kg	460	460	460

Options on the circuit breaker

- Motor operation *
- Closing release
- Shunt trip *
- Under voltage release *
- Set of auxiliary contacts
- Error contact
- Supply for test protective relay (battery block)
- Switch counter
- Automatic recloser
- Button press control on circuit breaker
- Remote control on circuit breaker
- Key interlock

Specifications to be indicated for circuit-breaker VA-2:
Short-circuit capacity, rated current, rated voltage and capacity to be secured

* available voltages: 24 V AC/DC, 48 V AC/DC, 110 V AC/DC, 220 V AC

DF-C-750

Metering cubicle.

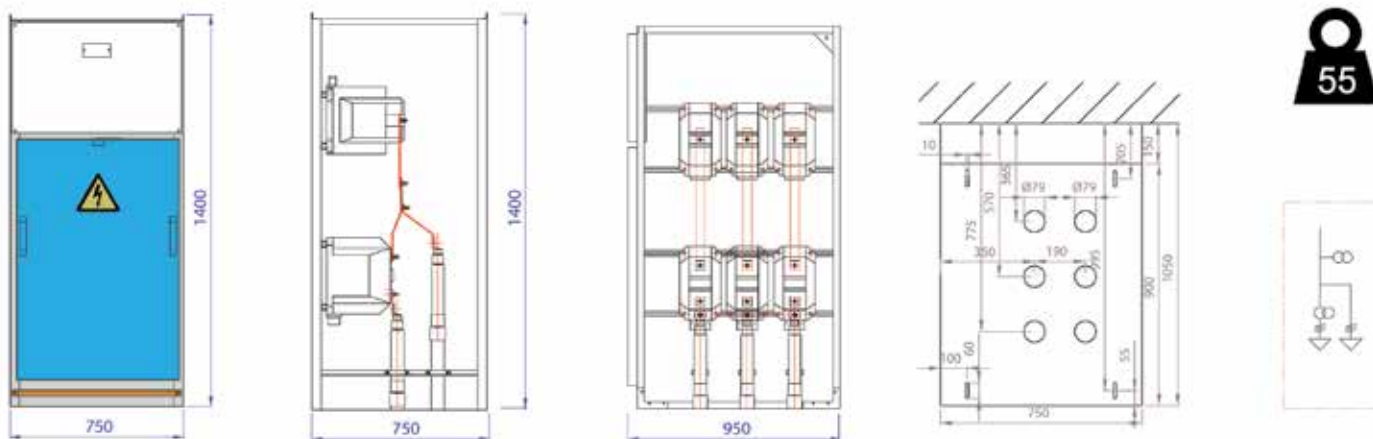

Standard Equipment

- 3 TI's xA => 5A
- 3 Tp's xV => 110V, V3

Options

- Additional current transformers
- Additional voltage transformer with or without MV and LV protection
- Support for the positioning of measuring transformers
- Measuring system with 3 CTs and 3 VTs
- Measuring system with kWh metering and Kvarh metering (requirements to be specified by the customer)
- Current measurement system
- Voltage measurement system
- Cubicle base: 200 mm, 300 mm or 400 mm height (Other dimensions on demand)
- Floor panels
- Low voltage compartment safety box to secure voltage circuits

The following current transformer CT specifications will be specified by the customer:

Primary current, secondary current, capacity and precision class, insulation class, rated short time current

The following voltage transformer VT specifications will be specified by the customer:

Primary voltage, secondary voltage, capacity and precision class, insulation class

APPLICATION

The DF-C-750 cubicle has been designed for positioning current and voltage transformers to measure energy consumption.

SPECIFICATIONS & DIMENSIONS

Rated Voltage	kV	12	17,5	24
Rated current	A	up to 630	up to 630	up to 630
Short-term current	kA	20	20	20
Time of the short duration of current	s	1	1	1
Width	mm	750	750	750
Depth	mm	950	950	950
Height	mm	1400	1400	1400
Weight (*)	kg	55	55	55

(*) Without equipment

Possible connections:

Bottom left in - bottom right out,
 Bottom right in - bottom left out,
 Bottom left in - top right out,
 Bottom right in - top left out,
 Top right in - top left out,
 Top left in - top right out

DF-K

Cable Cubicle and/or rail shaft.

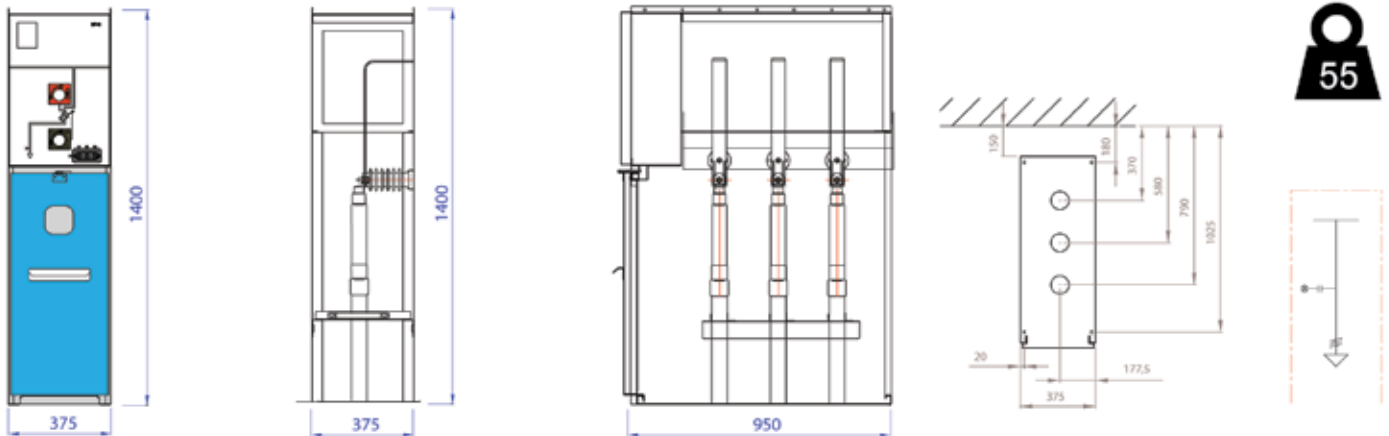

Options

- Holder for capacitive voltage indicators
- Capacitive voltage indicators
- Short-circuit detectors (to be specified by the customer when ordering)
- Earthing switch
- Set of auxiliary contacts on earthing switch
- Key interlock on earthing switch
- Earthing ball clamps
- Current transformers in the busbar
- Voltage transformers with or without protection in the busbar
- Cubicle base: 200 mm, 300 mm or 400 mm height (other dimensions on demand)
- Floor panels
- Door interlock

APPLICATION

Cubicles of the DF-3 type equipped to bring in a supply cable. However, a DF-K cubicle can also contain a busbar and can be used as rising cubicle of the rail set.

Possible connections:

Bottom in - top out,
Bottom in - top left out,
Bottom in - top right out

SPECIFICATIONS & DIMENSIONS

Rated Voltage	kV	12	17,5	24
Rated current	A	up to 630	up to 630	up to 630
Short-term current	kA	up to 20	up to 20	up to 20
Time of the short duration of current	s	1	1	1
Width	mm	M	M	M
Depth	mm	950	950	950
Height	mm	1400	1400	1400
Weight (*)	kg	55	55	55

* weight without equipment / **M** stands for **Made to measure**

OTHER OPTIONS & DIMENSIONS?

Please consult us for options and dimensions other than those mentioned in this catalogue.

4. PRODUCTION PROCESS

4.1. PRODUCTION PROCESS OF THE DF-3 CUBICLES AT NEVELE

The DF-3 system is the result of a combination of modern design technologies and economical, ergonomic and environmentally friendly production processes.

It all starts in the design department where your drawings will be **customized via CAD applications**. As soon as the drawings are approved, production can start. SGC - SwitchGear Company's steel plate department works with the most modern machinery, programmed by a CAD/CAM system.

The automated laser, punch and bend section can truly be considered **unique**. Two ultra-fast punch-corner cutting scissor machines are each provided with an automatic loading and sorting system which sorts and saves the items.

The numerous possibilities of the matrixes and plate feeders ensure that the cubicles can be uniformly produced as 100% user-friendly.

After the laser and punch processing, several panels are pleated on the fully automatic pleating bank, sorted and possibly moved on to a CNC-operated welding robot. This machine welds the fitting bolts and corners of the door panels and other parts.

The doors are now subjected to a complete process where they are degreased, stained, phosphated, passivated and given an additional rinse with demineralised water.

They are automatically sprayed with polyester powder in a powder spray cabin, after which they are heated in an oven at 200°C.

The complete cubicle structure has been constructed out of high-quality galvanized plates, it is resistant to corrosion and **has a long life span**.



“DF-3: modern technology & ergonomic, eco-friendly production processes...”



In the assembly hall the specialized units are first pre-assembled. This division allows us to devote the necessary care to obtaining a perfect balance with, and a correct assembly of the various components. In the next stage the cubicles are assembled. This stage is subject to strict assembly procedures.

In a next stage all cubicles are subjected to a severe control. The electrical tests include resistance measurement of the RV53 load break switch and integrated earthing switch. Subsequently, the cubicle is subjected to a power frequency test 28/38/50 kV - 1min. The verification of the bounce and synchronism of the load break and earthing switch is another important routine test. The mechanical tests are performed to examine the correct position of all parts and interlocks. All important connections are sealed during this stage.

Right before being dispatched the cubicles will undergo a final control; this is where custom, optional features will be installed and checked separately.

The cubicle is now ready for dispatch ... **to a happy and satisfied customer!**



“Our cubicles are resistant to corrosion and have a long life span...”



5. OTHER PRODUCTS BY SGC - SWITCHGEAR COMPANY

DR-6/DT-6

Compact and/or extensible SF₆ insulated Ring Main Unit with load break switch or integrated vacuum circuit breaker.



DF-2/DF-2+

Modular and extendible switchgear.



DW-2

(AIS metal-clad) A family of air-insulated medium voltage switchgear solutions for indoor installations.



INTERESTED IN OUR PRODUCTS, PRODUCTION PROCESS OR PLANT?

Please contact our Sales Team (sales@switchgearcompany.eu) for a guided tour.





3

BUILT TO LAST!
SGC



SGC - SwitchGear Company.

Medium-voltage switchgear, built to last.

SGC - SwitchGear Company has been supplying reliable products for electrical distribution for more than 30 years. Innovative ideas and environmental care are the driving forces behind SGC - SwitchGear Company. The development of complete solutions consists of a minimum number of components, all of which have an exceptional life span. SGC - SwitchGear Company stands for exceptional quality and superior customer care. Your desired specifications and deadlines are our main concern.

An exclusive factory and highly automated production lines are key factors in our "state of the art" components and systems. It enables us to develop the DF-2, DR-6/DT-6, DF-3 and DW-2 to the highest quality standards. When it comes to delivery times, prices and products SGC - SwitchGear Company delivers.

SGC

SwitchGear Company

SGC nv SwitchGear Company

Moorstraat 24

B-9850 Nevele

Belgium

☎ +32 (0)9 321 91 12

📠 +32 (0)9 321 91 13

Internet: www.switchgearcompany.eu

E-mail: info@switchgearcompany.eu

THE SPECIALIST IN MEDIUM VOLTAGE SWITCHGEAR