

## Absolute Encoder with Serial Communication



- Magnetic rotary encoders
- SSI Absolute (10 bit – 12 bit)

### Main Applications

Position/ Angle Measurement Applications for Automation Systems

### Specifications

Measurement type	Magnetic absolute
Resolution	10 bit/ 360° or 12 bit/ 360°
Output signal	SSI
Output signal type	5V TTL
Supply voltage	8–24 VDC (Standard) or 5 VDC (Optional)
Case diameter	Ø 50mm
Rod diameter	Ø 8mm
Case material	Aluminium/ steel
Rod material	Stainless steel
Max. speed	1000 rpm
Working temperature	-20.....+80 °C
Electrical connection	2.5m Cable (Standard) or Connector (Optional)

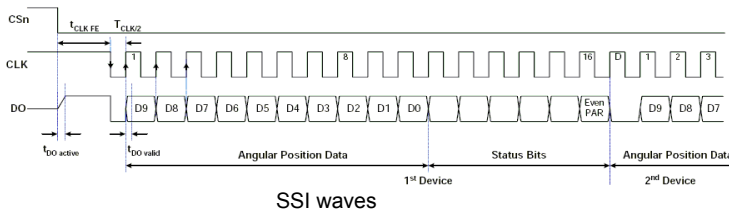

SSI waves

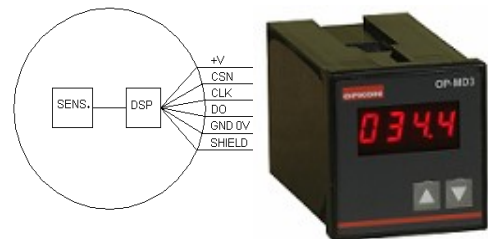

OP-MD3 or OP-MD4 connection

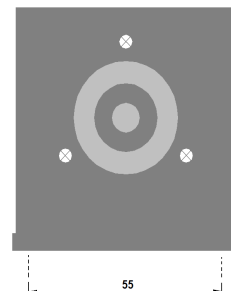
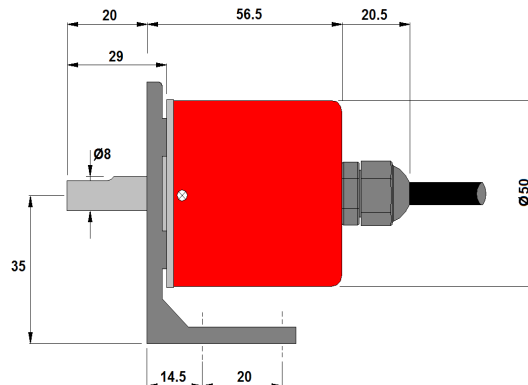
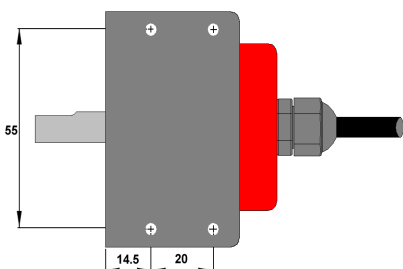
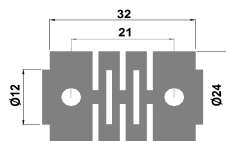
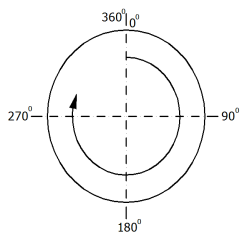

### Ordering Procedure/ An Order Sample

MRA	50	TT	12	SSI	24V	2.5 m
Model	Case diameter 50mm	Control output TT = TTL	Resolution 10bit/ 360° or 12bit/ 360°	Output type SSI = Synchronous series interface	Supply voltage 8-24 VDC or 5 VDC	Cable length 2.5 meter or Connector

\_\_\_\_\_