



stay connected

INSIGHT

A Tour Through Murrelektronik





**26 BRANCH OFFICES
AND 5 PRODUCTION PLANTS**

Oppenweiler, Germany
Production of Fieldbus Systems,
Interface Modules

Stollberg, Germany
Production of Connectors

Stod, Czech Republic
Production of Interface Modules,
Switch Mode Power Supplies,
Transformers

Shanghai, China
Production for the
Asian markets



**STAY CONNECTED – REPRESENTED ON
ALL CONTINENTS WORLDWIDE**

The company was founded
in 1975 by Franz Hafner

Over 2,000 employees, including
200 sales reps and customer
service center technicians

Top student training is very important
for Murrelektronik. Each year we offer
a large number of apprenticeships in
technical and commercial areas, as
well as in logistics





MURRELEKTRONIK FIGURES & FACTS

Atlanta, USA
Production of Connectors



MURRELEKTRONIK IS YOUR PARTNER

- Over 65,000 products available to order conveniently in our online shop
- Subdivided into four product groups:
 - **Electronics in the Control Cabinet**
 - **Interfaces**
 - **Connection Technology**
 - **I/O Systems**
- For industries and market segments like:
 - **Machine Tools**
 - **Machine Building and Plant Engineering**
 - **Assembly and Handling Technology**
 - **Food & Beverage**
 - **Automotive Industry**
 - **Warehousing and Logistics**
- Founded in Oppenweiler, Germany, in 1975
- Family-owned company
- Over \$264 million turnover in 2015



**CUSTOMER
SERVICE**
INDIVIDUAL
AND RELIABLE
ON-SITE HELP

Products for process-
optimized installations

Developing cost-efficient solutions



MURRELEKTRONIK YOUR BENEFITS

MURRELEKTRONIK OFFERS REAL BENEFITS

- Over 200 sales reps and personal contacts in technical and inside sales
- On-site support
- Murrelektronik Express Service (MEX) guarantees the production of individual cable lengths within 48 hours
- 4 international warehouses (USA, Brazil, China, Germany)
- 1 million products in stock

mex
More service



Development, production, logistic – all processes focus on our customers



**SYSTEMATIC AND SUSTAINABLE
QUALITY MANAGEMENT
ACCORDING TO EN ISO 9001**

Accredited test center and
EMC laboratory



Endurance tests under
extreme conditions



Practice-oriented test
procedures guarantee best
product quality



MURRELEKTRONIK QUALITY

MURRELEKTRONIK STANDS FOR QUALITY

- Accredited test center and EMC laboratory
- Individualized advice and support
- No hazardous materials used
- Complies with RoHS requirements
- First-class design and production quality:
“Made in Germany”

Product tests are already
done in the early project
phases





WORLDWIDE AND INDUSTRY-WIDE!
BENEFIT FROM OUR CROSS-INDUSTRY EXPERIENCE
AND EXPERTISE

Warehousing & Logistics



Food & Beverage



Machine Tools



Automotive Industry



Airports



Offshore Industry





MURRELEKTRONIK REFERENCES

WE STAY CONNECTED TO OUR CUSTOMERS

- Customers in many industries
- Regional, national and international references
- ABB / Arburg / Atlas Copco Rock Drills / Audi
BMW / Bosch / Bosch Rexroth / Chiron / Daimler
Deckel Maho Gildemeister / EMAG / Festo
FORD-Werke / Grob / HAWE Hydraulik / Heller
Hermle / Homag / Index Werke / Krones / Liebherr
LQ / Moeller / Mori Seiki / OKU / Rieter / Rosenbauer
Salvagnini / Schneider Electric / Schuler / Schweiger
Sidel / Siemens / Stihl / Teamtechnik / Trumpf
Volkswagen / Witron

Paper Industry



stay connected

At Murrelektronik, we create
lasting connections, both
personally and technically.



1975

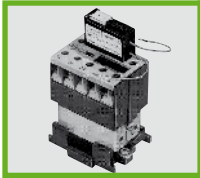

Company founded | Pioneer product: RC-501/220

1976



First international branch office in Switzerland

1977



First presence at trade fairs: Eltec, Dortmund and EMO, Hanover (Germany)

1978

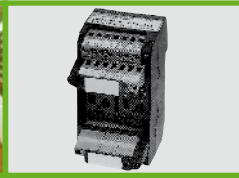

Interface technology the second product range | 30 employees working in Oppenweiler

1982



Murrelektronik becomes sponsor of the TV Oppenweiler

1983



Branch office in China founded | First trainee is hired

1984



Third product range developed: valves and sensor connectors

1985

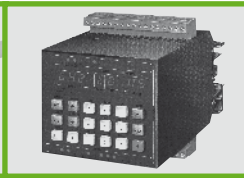

Beginning of automation technology | Number of employees rises to 148

1986



Murrelektronik enters the field of power supplies with switch mode power supply units

1989



Moving to the current building with 270 employees | Pioneering into fieldbus technology

1993



Murrelektronik acquires the company KSG in Stollberg, Germany

1994



Interface technology is expanded | Branch office in USA is founded

1995



Commitment made to Brazilian charity house for children: Casa do Zezinho | Branch office in Brazil founded

1997



Murrelektronik has online presence, and unveils the new company logo

1999



New trade fair concept is created | 400 employees in Oppenweiler

2001



The Murrelektronik group expands to 1,000 employees worldwide | Launch of the MVK plastic fieldbus system

2002



Start of SAP | Launch of MVK Metal, a product for demanding requirements

2004



Milestone: Cube67 wins the coveted Automation Award

2005



Breaking ground for the new logistics center in Oppenweiler | 30 years Murrelektronik

2006



Murrelektronik's Cube67 receives the IF Design Award

MURRELEKTRONIK HISTORY

Murrelektronik unites Yesterday, Today and Tomorrow ...

In 1975, Franz Hafner began this company in Oppenweiler with a vision. Today, Murrelektronik is a worldwide company that is still owner-managed and driven by that vision.

2007



Murrelektronik's **hot air balloon** takes off | Introduction of **MICO** = Top product

2008



Murrelektronik is among the **TOP 100** Mid-Sized Companies

2009



Start of the campaign **CONNECTIVITY**

2010



Entry into **active safety technology** | **Branch office in Turkey** is founded

2012



CONNECTIVITY by Murrelektronik becomes a system consulting brand

2013



Murrelektronik's **Connectivity App** Wins the **Automation App Award** | Murrelektronik has **1,700 employees** worldwide

2014



Murrelektronik has received the award for: **Best B2B Shop** in the Electronic Industry

2015



Murrelektronik has received the **"Best Place to Learn"** award | **40 years Murrelektronik**

MURRELEKTRONIK
HAS OFFICES
WORLDWIDE
TO ASSIST YOU



GERMANY

Murrelektronik GmbH
Falkenstraße 3
D-71570 Oppenweiler
Phone +49 7191 47-0
Fax +49 7191 47-130
info@murrelektronik.com
www.murrelektronik.com



ARGENTINA

NAKASE SRL
ventas@nakase.com
www.nakase.com.ar



AUSTRALIA

Sick Pty. Ltd.
sales@sick.com.au
www.sick.com.au



AUSTRIA

Murrelektronik GmbH Austria
info@murrelektronik.at
www.murrelektronik.at



BELGIUM

Murrelektronik B.V.B.A.
info@murrelektronik.be
www.murrelektronik.be



BRAZIL

Murrelektronik do Brasil
Indústria e Comércio Ltda.
info@murrelektronik.com.br
www.murrelektronik.com.br



BULGARIA

Murrelektronik GmbH Austria
info@murrelektronik.at
www.murrelektronik.at



CANADA

Murrelektronik Canada
2sales@murrelektronik.ca
www.murrelektronik.ca



CHILE

Electrónica Rhomberg Ltda.
ventas@rhomberg.cl
www.rhomberg.cl



CHINA

Murrelektronik Components Co. Ltd.
info@murrelektronik.com.cn
www.murrelektronik.com.cn



CROATIA

Murrelektronik GmbH Austria
info@murrelektronik.at
www.murrelektronik.at



CZECH REPUBLIC

Murrelektronik CZ spol. s.r.o.
info@murrelektronik.cz
www.murrelektronik.cz



DENMARK

Murrelektronik Aps
info@murrelektronik.dk
www.murrelektronik.dk



EGYPT

DANA Import & Export
usama@dana-egy.com
www.murrelektronik.com/en



FINLAND

Murrelektronik Power Oy
sales@murrelektronik.fi
www.murrelektronik.fi



FRANCE

Murrelektronik S.A.S.
info@murrelektronik.fr
www.murrelektronik.fr



GREAT BRITAIN

Murrelektronik Ltd.
sales@murrelektronik.co.uk
www.murrelektronik.co.uk



HUNGARY

Murrelektronik Kft.
info@murrelektronik.hu
www.murrelektronik.hu



INDIA

Murrelektronik India
chetan.t.a@murrelektronik.in
www.murrelektronik.in



INDONESIA

PT Sensor Haustama Jaya
adminid@sensorhaus.com
www.sensorhaus.com



ISRAEL

O.M.S.T Marketing & Import Ltd.
miki@omst.co.il
www.omst.co.il

ISRAEL

Ancitech Ltd.
info@ancitech.com
www.ancitech.com



ITALY

Murrelektronik S.r.l.
info@murrelektronik.it
www.murrelektronik.it



JAPAN

K.MECS Co., Ltd.
info@kmecs.co.jp
www.kmecs.co.jp



KENYA

Profa-Tech Ltd.
info@profa-tech.com
www.profa-tech.com



MALAYSIA

SensorHaus (M) Sdn. Bhd.
adminmy@sensorhaus.com
www.sensorhaus.com

PAN-M Solution
pms@gmail.com
www.murrelektronik.com



NETHERLANDS

Murrelektronik B.V.
sales@murrelektronik.nl
www.murrelektronik.nl

MURRELEKTRONIK REPRESENTED WORLDWIDE

**NEW ZEALAND**

Sick Pty. Ltd.
sales@sick.co.nz
www.sick.co.nz

**NORWAY**

Murrelektronik A.S.
post@murrelektronik.no
www.murrelektronik.no

**PAKISTAN**

Overseas Enterprises
info@oe.com.pk
rehan_k@oe.com.pk
www.oe.com.pk

**POLAND**

Murrelektronik Sp. z o.o.
info@murrelektronik.pl
www.murrelektronik.pl

**PORTUGAL**

F.Fonseca S.A.
ffonseca@ffonseca.com
www.ffonseca.com

**ROMANIA**

Murrelektronik GmbH
info@murrelektronik.at
www.murrelektronik.at

**RUSSIA**

Murrelektronik
igor.kalinin@murrelektronik.de
www.murrelektronik.ru

**SERBIA**

Murrelektronik GmbH Austria
info@murrelektronik.at
www.murrelektronik.at

**SINGAPORE**

Pan-M Pte. Ltd.
alvin@pan-m.com.sg
www.murrelektronik.com

**SINGAPORE**

SensorHaus Pte. Ltd.
adminsg@sensorhaus.com
www.sensorhaus.com

**SLOVAKIA**

Murrelektronik GmbH Austria
info@murrelektronik.at
www.murrelektronik.at

**SLOVENIA**

Murrelektronik GmbH Austria
info@murrelektronik.at
www.murrelektronik.at

**SPAIN**

Murrelektronik Spain S.L.U.
ventas@murrelektronik.es
www.murrelektronik.es

**SOUTH AFRICA**

Rubicon Electrical
and Automation
greg@rubiconsa.com
www.rubiconsa.com

**SOUTH KOREA**

Murrelektronik Korea Ltd.
info@murrelektronik.kr
www.murrelektronik.kr

**SRI LANKA**

Sim Lanka (Pvt) Ltd.
info@simlanka.com
www.simlanka.com

**SWEDEN**

Murrelektronik AB
info@murrelektronik.se
www.murrelektronik.se

**SWITZERLAND**

Murrelektronik AG
info@murrelektronik.ch
www.murrelektronik.ch

**TAIWAN**

Lintronix Co. Ltd.
info@lintronix.com.tw
www.lintronix.com.tw

**THAILAND**

Maxtech Control Co., Ltd.
info@maxtechcontrol.co.th
www.maxtechcontrol.co.th

**TURKEY**

Murr Elektronik San. ve Tic. Ltd. Sti
info@murrelektronik.com.tr
www.murrelektronik.com.tr

**UNITED ARAB EMIRATES**

King Power Electrical Accessories
Trading
kpower@emirates.net.ae
www.murrelektronik.com/en

**USA**

Murrelektronik Inc.
2info@murrinc.com
www.murrinc.com

**VIETNAM**

OMINA Industrial Automation J.S.C
inquiry@omina.com.vn
www.omina.com.vn

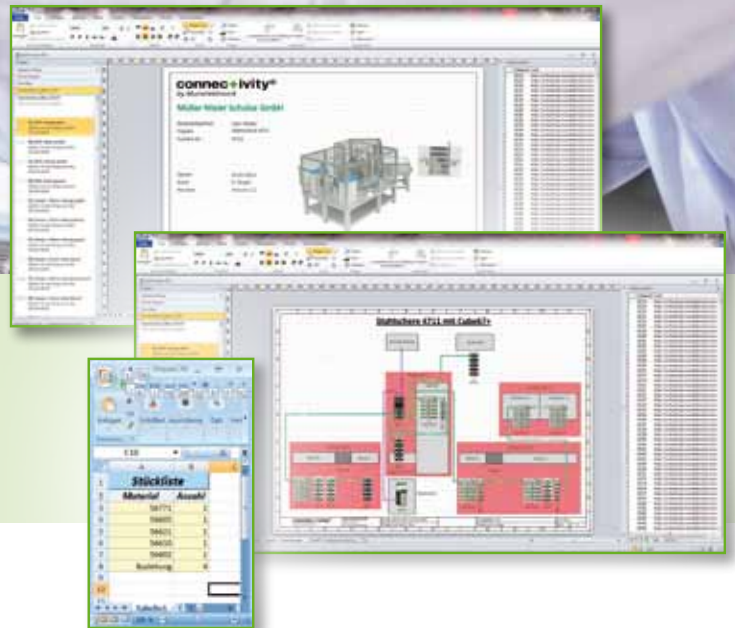

**OUR CONSULTING TOOLS
CREATE SOLUTIONS**

**SYSTEM ADVICE WITH
CONNECTIVITY CITY**

Go from the industry overview
to your application ...

... to the appropriate product... ... and link to the online catalog



CONNECTIVITY BY MURRELEKTRONIK

PROCESS OVERVIEW

- On-site analysis
- Exchanging the basic documentation
- Discussing the current status

- Concept overview
- Analyzing advantages and disadvantages
- Bill of materials

- Customer-specific requirements
- Industry-specific requirements
- Several concept options

- E-plan and CAD data
- Electronic catalog data (BMEcat)
- Setup support

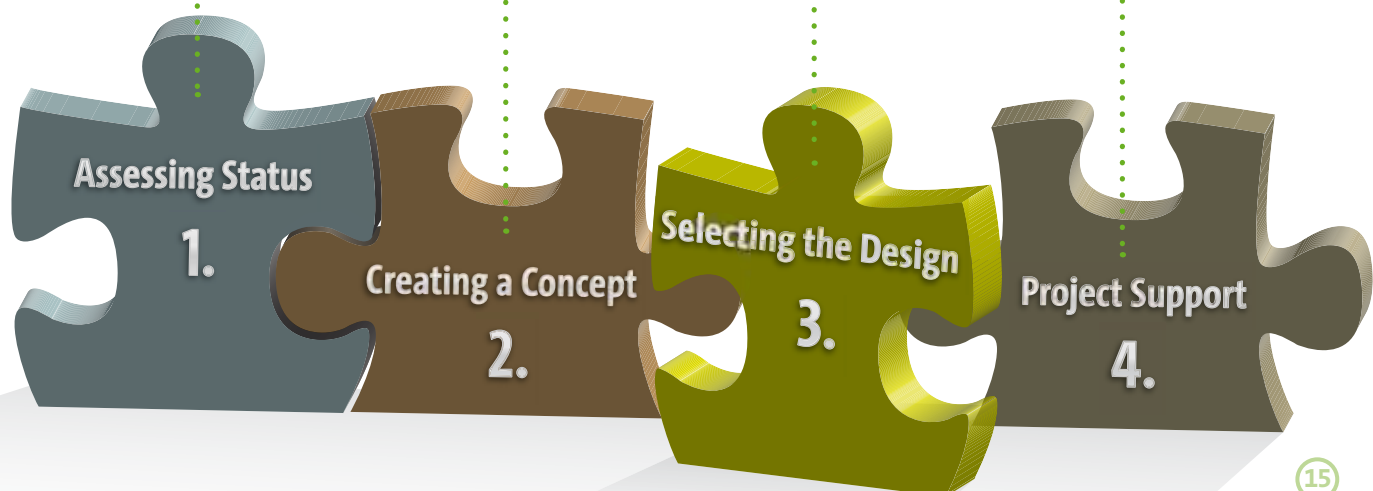

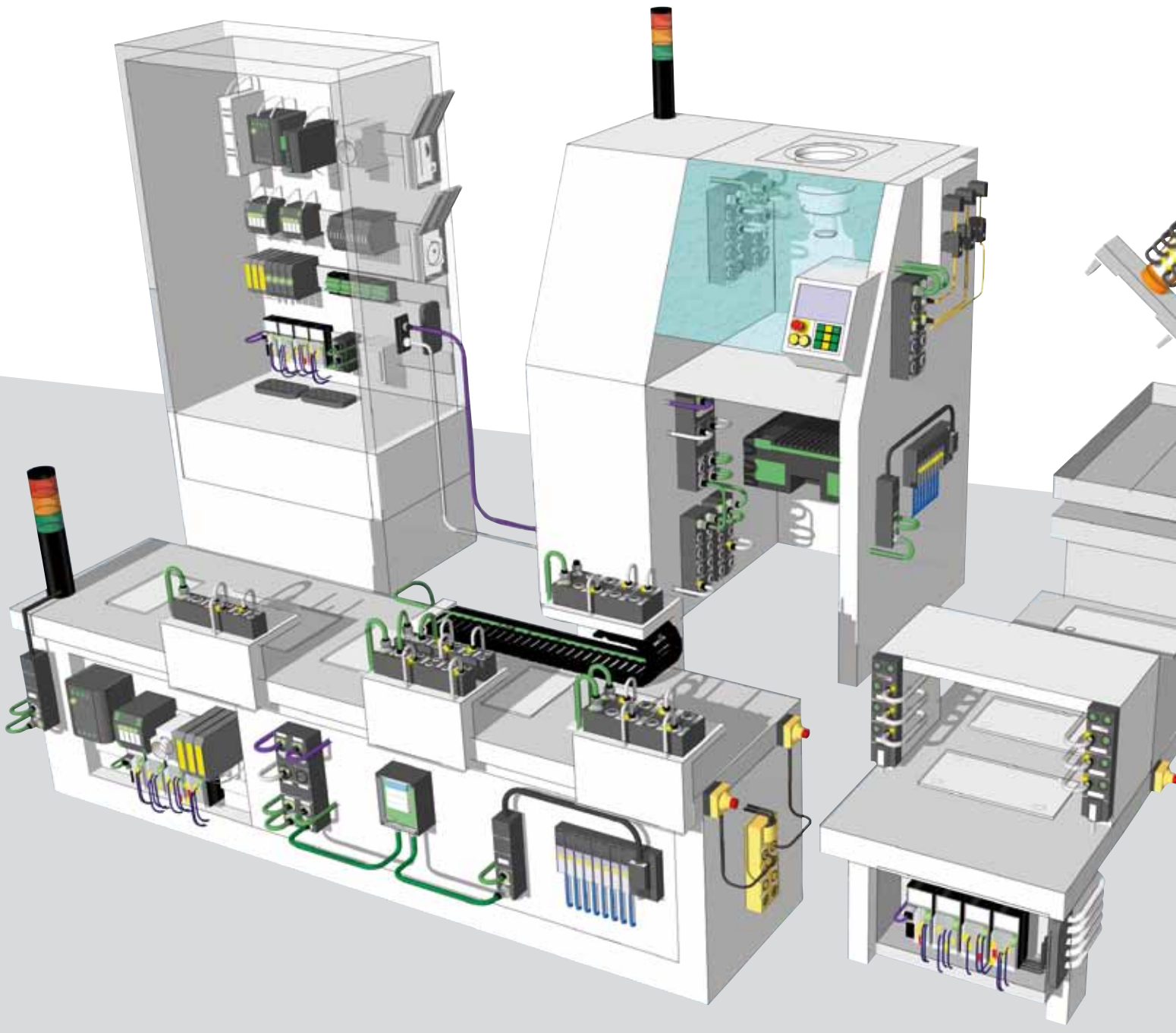

**WITH CUSTOM INSTALLATION CONCEPTS
SAVE TIME AND MONEY!**

**ELECTRONICS IN
THE CONTROL CABINET**

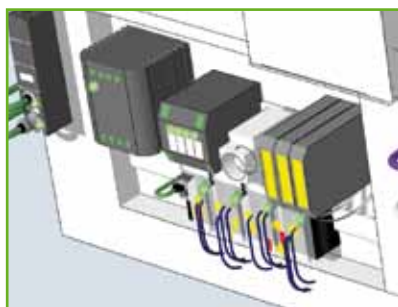

INTERFACES



CONNECTION TECHNOLOGY

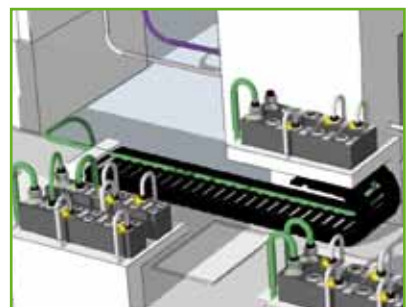

MURRELEKTRONIK BEST PRACTICE APPLICATIONS

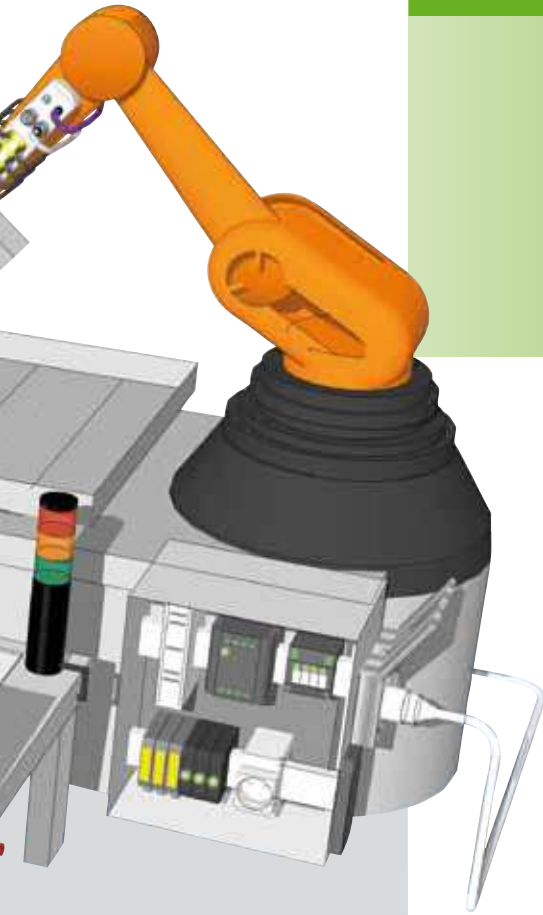

REDUCING THE TOTAL COSTS WHEN INSTALLING I/Os

- Flexible installation concepts =>
Optimized processes in all segments
- Convenient diagnostics =>
Increased machine availability
- Reducing assembly and setup time
- Optimizing logistics
- Fewer wiring efforts

INTEGRATED APPROACH = COST-EFFECTIVE RESULTS!

I/O SYSTEMS





1 ELECTRONICS IN THE CONTROL CABINET



2 INTERFACES



3 CONNECTION TECHNOLOGY



4 I/O SYSTEMS



PRODUCTS

4 PRODUCT RANGES



1 ELECTRONICS IN THE CONTROL CABINET

EMC FILTERS, SUPPRESSION TECHNOLOGY, INTERFACE,
POWER SUPPLIES AND POWER DISTRIBUTION

Electronic components for applications in the cabinet, for different tasks and applications on a high technical level.

2 INTERFACES

SERVICE INTERFACE, CABLE ENTRY SYSTEMS,
SIGNAL TOWERS

Over 4,000 interface combinations possible to go from the control cabinet into the field, offering maximum flexibility.

3 CONNECTION TECHNOLOGY

CONNECTORS, CABLES

Murrelektronik offers one of the most comprehensive product ranges on the market to connect sensors and actuators.

4 I/O SYSTEMS

FIELDBUS TECHNOLOGY, DISTRIBUTION SYSTEMS

I/O Systems are the distributing link between PLC and sensor/actuator level that go from passive distribution systems to fieldbus technology in compact or modular design.



1

EMC FILTERS

EMC filters are essential components that ensure interference-free operation of machines and systems. They function in two directions: First, they dampen interferences that originate from the inside of a machine or a system, a problem that is hard to avoid. Second, they ensure that interferences from adjacent machines and installations do not disturb the intact field within the system. Murrelektronik offers a comprehensive product line with single and 3-phase units (up to 180 A).

Filters are available in a slim book design with convenient DIN rail mounting. Two-stage filters help to meet the limits of radio frequency interference in residential and mixed zones. Ground straps are another important suppression technology: They connect filters to the protective earth (PE). This way, ground straps discharge all interference safely and comply with the relevant standards.

PRODUCTS

ELECTRONICS IN THE CONTROL CABINET

1 SUPPRESSION

Suppressor modules from Murrelektronik help avoid damage when load voltage spikes create problems (for example contactors, motors or valves). They enable an EMC-compatible design of systems, machines, and equipment. They considerably limit voltage spikes – especially if they are installed close to the interference source. Using a suppressor increases the lifetime of contacts and coil-windings, as well as reduces the operating and maintenance costs. When developing the products, Murrelektronik collaborates closely with the manufacturers of motors, contactors, and valves. Therefore, the modules are precisely matched for the sources of voltage spikes.





1 POWER SUPPLY AND DISTRIBUTION

Power supply modules are the heart of every control cabinet. They set the pace. Murrelektronik is your one-stop supplier for these products! We offer a wide range of transformers for adjusting voltages – they are available as control, isolation and safety transformers.

Rectified power supplies (for transforming AC voltage into smoothed DC voltage) and switch mode power supplies (for transforming into regulated DC voltage) are also offered in a wide product range.

Murrelektronik's portfolio also features a wide selection of redundancy and buffer modules. They protect power supplies from interferences. Intelligent current management is another important product line. MICO monitors currents, indicates when approaching the maximum load, and detects over-stress.

PRODUCTS

ELECTRONICS IN THE CONTROL CABINET

1 INTERFACE TECHNOLOGY

Converting, amplifying, transferring signals – interface components have to fulfill various requirements while being potential-free. Murrelektronik offers a comprehensive product range for this field of automation technology. Relays are available for all voltage ranges. They are especially slim, so they don't take up a lot of space in the control cabinet.

Optocoupler modules from Murrelektronik are suitable for coupling and isolating elements for various control functions. Active interface modules collect signals and transfer them into formats that the following receiver can process. Murrelektronik's active brake rectifiers simplify connecting DC brakes. The tree switches can combine up to eight Ethernet terminal devices in a single, compact device.





PRODUCTS INTERFACES

2

SERVICE INTERFACE, CABLE ENTRY SYSTEMS, SIGNAL TOWERS

Interfaces that connect the control cabinet to the field are an important part of all machines and installations. Murrelektronik's MSDD Modlink front panel interfaces are a modular system for servicing the panel. They are designed to connect analysis or programming devices to the control cabinet. The MPV control cabinet coupling is the right solution for permanent plug connections. Murrelektronik also supplies cable entry systems that ensure sealed connections. The innovative MSDD hybrid fieldbus couplings combine repeater and entry systems. Eurocard holders connect individual parts to control units. We have large number of outlets available for almost all countries worldwide. For optical indication of all operating states, the signal towers of the Modlight product group are available in different models for all kinds of machines and installations.

PRODUCTS

CONNECTION TECHNOLOGY

3 CONNECTORS AND CABLES

Murrelektronik offers one of the most comprehensive program ranges on the market for connecting sensors and actuators. A great number of connectors are available from stock or will be produced within 48 hours from when you place your order – with order quantities starting from 1 piece!

The connectors are available in various forms. The product range includes the classic M8- and M12 round plug connectors, valve connectors and many more models. Different types of connectors are offered: with connection cable, with open ended wires or for field wiring. They feature various cable materials, wire sections, jacket colors, and number of poles. Murrelektronik offers models for demanding industrial environments (as used in machine and plant construction) as well as for applications that require quick connections, like in handling technology. Furthermore, the selection comprises versions for outdoor applications, the Food and Beverage industry, or for the mobile hydraulic sector.





4 FIELDBUS TECHNOLOGY

With Murrelektronik's fieldbus technology you can connect sensors and actuators conveniently and systematically to a higher control level. This allows cost-effective installation and automation solutions in machines and plants for many industries like: assembly and handling technology, machine building, materials-handling technology, logistics, process technology and building installations.

Murrelektronik offers solutions for any application. Cube67 is a modular system especially for application-friendly installations. Impact67 equals major cost savings. MVK Metal is made for demanding industrial environments. MASI is unique because of its extremely simple installation technology. Murrelektronik's fieldbus modules enable convenient and thorough diagnostics: with a clearly visible LEDs at the port and error messages in the control. The principle of "changing the bus without changing the system" provides flexibility. For safety-related applications, suitable solutions are available that guarantee optimum protection of man and machine. Products for the control cabinet complete the fieldbus technology range.

PRODUCTS

I/O SYSTEMS

4 DISTRIBUTION SYSTEMS

Murrelektronik's passive distribution boxes provide a convenient method for connecting sensors and actuators to the control cabinet. These cost-efficient, safe and space saving installation solutions are designed for small and mid-sized machines. A wide range of application is possible. The comprehensive product portfolio enables the use in normally dry applications (warehousing, packaging, handling), heavy duty applications (metal and wood working, or polymer processing), in the Food and Beverage sector up to mobile outdoor applications.

Compared to single wire solutions with terminal boxes, installations with passive distribution boxes offer many advantages: smaller design, tighter connections, shorter assembly time and fewer materials are needed. Their integrated LEDs enable diagnostic options. Moreover, pluggable solutions with distribution boxes (M8 and M12) eliminate wiring errors.





BE CLEVER – REDUCE COSTS AND INCREASE EFFICIENCY
WITH PREDEFINED COMPONENTS OR PRODUCTS THAT ARE
SPECIALLY DESIGNED FOR YOU

Murrelektronik offers a wide range of predefined products
that meet your specific requirements

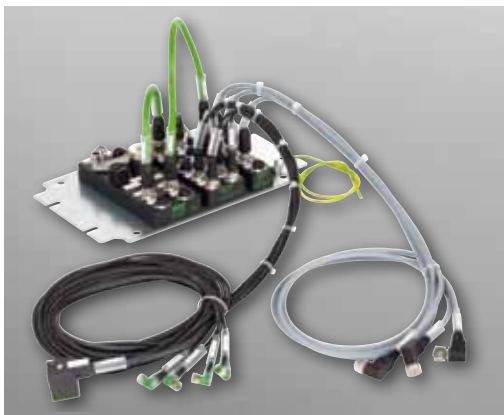

SERVICE RESOURCES

BRIGHT IDEAS

- Kabelbutler™
- Value Added Assembly
- Customized Developments



The right part in the right quality at the
right time in the right place –
Kabelbutler™ is your logistics solution





INCREASE EFFICIENCY AND COST-EFFECTIVENESS
BENEFIT FROM THE TECHNICAL EXPERIENCE

They always find the answers to your questions – Murrelektronik's Customer Service Center (CSC)



Convenient online ordering:
👉 shop.murrelektronik.com



SERVICE SUPPORT

SERVICE WITH TECHNICAL BACKGROUND

- Technical Support for Cross Referencing
- Customer Service Center (CSC)
- eCatalog/BMEcat
- Online Catalog
- Murrelektronik App

Murrelektronik App

Murrelektronik product information in the palm of your hand – perfect for use in the field. Just scan the bar code or type in the part number and receive access to installation instructions, data sheets, construction files and many more.





stay connected

➔ www.murrelektronik.com

The information contained herein has been compiled with the utmost care. Liability for the correctness, completeness and topicality of the information is restricted to gross negligence.

Our company embraces social responsibility in all aspects of our business activities. Our brochures are printed using environmentally friendly production techniques and products.

