

EMC cable glands.

AGRO cable glands for interference-free cable installations.





EMC.

A topic with serious consequences.

Electromagnetic compatibility (EMC) is something that everyone in our modern world is confronted with. For instance, if a bothersome tone in the radio alerts you that your mobile phone is ringing, this is a typical case of an electromagnetic interaction between two pieces of equipment.

In this context, disturbing noises are only the most harmless consequences of such unwanted interactions. When your expensive high-tech car won't move because of electromagnetic incompatibilities in the on-board computer, things become much more upsetting and expensive. This topic takes on a whole new meaning when the functions of entire industrial plants or rail vehicles are disrupted or even brought to a standstill because of EMC problems. The financial damages due to a manufacturing outage can quickly reach enormous amounts in the 5- to 7-digit Euro range – not to speak of possible loss of data or damage to the company's image arising from delayed deliveries.

As our everyday lives and businesses tend to increasingly rely on technology, the issue of EMC continually gains added importance. More and more electronic devices are being used in the home, industrial plants are becoming more complex, and it's hard to imagine life without new wireless technologies such as GPS, Bluetooth or WLANs. Just as the electronics industry is growing, so too is the level of electromagnetic interference because basically every piece of electrical equipment is susceptible to EMC or itself even creates such interference. Achieving 100 percent electromagnetic compatibility is nothing more than wishful thinking. In fact, it has become mandatory to address EMC aspects early in the planning and development phases of machines, systems and equipment and in doing so include all relevant components. In this way, expensive rework can be avoided. Specifically, statistics indicate that almost 40 percent of all electronic failures can be traced back to insufficient EMC measures.



| | |
|---|----|
| Standards and regulations. EMC directives. | 04 |
| The most important things for interference-free operation. Shielding and contact. | 05 |

| | Requirements | Products | |
|---|---|--------------------------------------|----|
| EMC cable glands | Quick, convenient installation. | Progress® MS EMC easyCONNECT. | 06 |
| | Quick assembly. | Progress® MS EMC Rapid. | 08 |
| | Constant contact quality with lowest transfer impedancet. | Progress® MS EMC. | 10 |
| | Concentric screened tap connection for high leakage current. | Progress® MS EMC Series 85. | 12 |
| Further products and Accessories | Enhanced requirements to EMC cable entry | Further designs | 14 |
| | Auxiliaries for EMC cable entry | Accessories. | 14 |
| | Technical overview | | 15 |
| | AGRO cable glands. Systems and solutions for professional cable entry. | | 16 |



Standards and regulations. EMC directives.

What, exactly, is EMC? Every electrical device generates an electromagnetic field around itself, and this field in turn can induce currents and voltages in other electrical devices. Depending on the intensity of the mutual coupling, this effect can lead to malfunctions, reduced functionality or even total failure of the equipment.

In European Standard EN 61000, the term EMC is defined as follows: Electromagnetic compatibility is the ability of a piece of electrical equipment to function satisfactorily in an electromagnetic environment without influencing this same environment, in which other equipment is located, more than is permitted. The active and passive aspects of this definition can be more clearly illustrated with the example of a pacemaker. The operation of such a pacemaker should not in the least be compromised by environmental influences to ensure that the patient's life is not put in danger. On the other hand, the patient himself must not be harmed by the operation of the device itself.

Basically, a distinction is drawn between electromagnetic influences in the low-frequency and high-frequency regions. In the low-frequency region, interference arises due to the various forms of coupling (galvanic, inductive, capacitive) between two electrical circuits. In the high-

frequency region starting at 10 kHz and above, in contrast, there are additional field-related coupling effects that have an effect on susceptible equipment, which can act as a sink for the interference – in other words, on receivers, electrotechnical equipment or electrical systems. Furthermore, there is a distinction between natural sources of interference such as lightning and artificial causes such as TV and radio transmitters, frequency converters and switching operations.

When it comes to EMC, not only technical issues are of interest but also legal aspects. In general, electrical products, machines and systems are subject to various directives, laws, ordinances and regulations. The legal provisions applicable to EMC at the European level are intended to guarantee not only free movement of goods within the domestic markets but also to ensure the protection of health and safety for people as well as to protect the environment, radio operations and consumers. Therefore, within the EU, only those products can be brought to market which meet the protection regulations established in the EMC Directive (2004/108/EC). Accordingly, manufactures must design their products such that no unacceptable electromagnetic interference arises between two devices or systems, and this is to be verified with corresponding test procedures and the confirmation made visible with a CE marking.

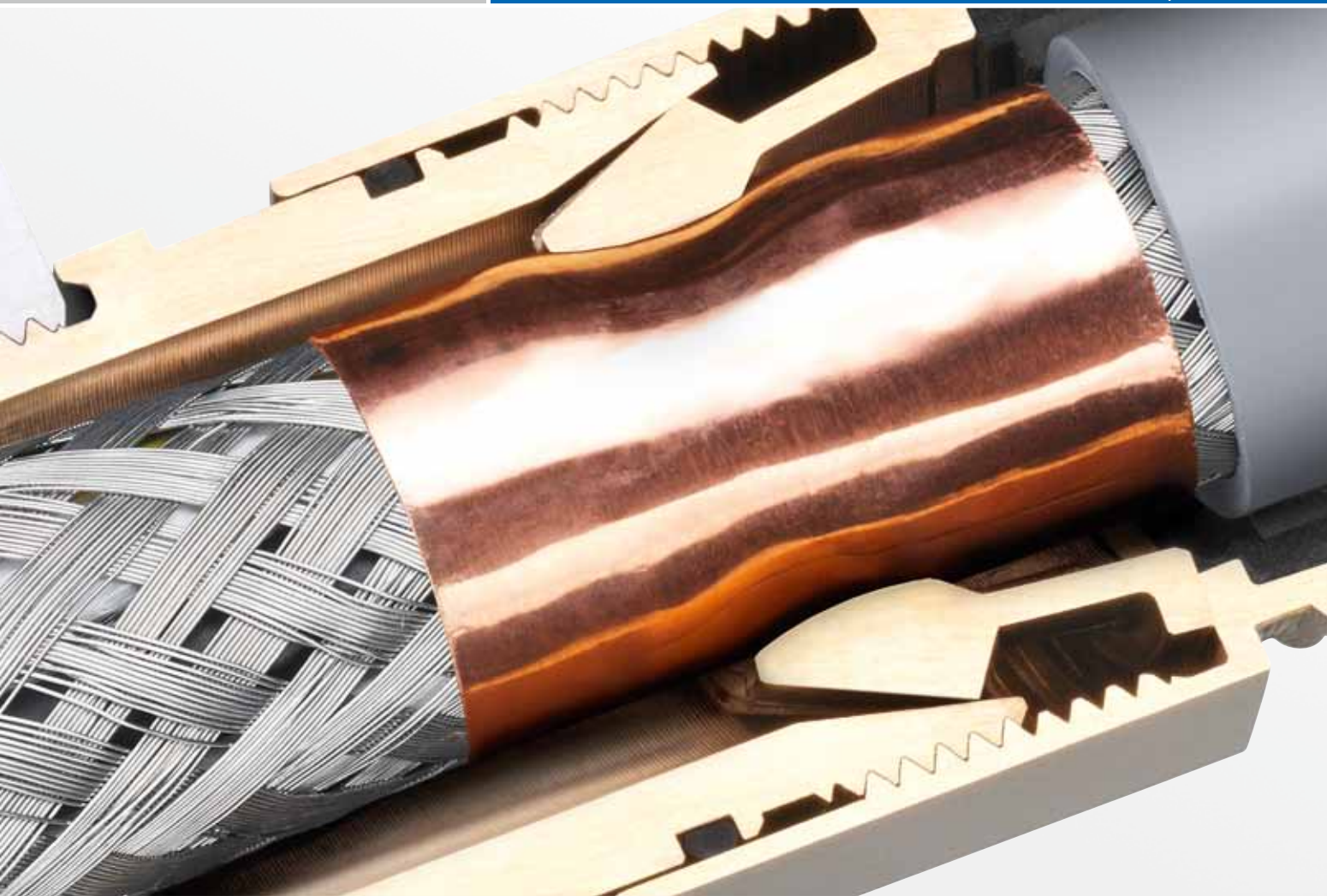

The most important things for interference-free operation: **Shielding and contact.**

In the industrial sector, EMC plays a particularly key role because complex machines and systems are extremely susceptible to electromagnetic interference. Such undesired EMC effects, however, can be counteracted with the effective shielding of all components. On the one hand, good shielding reduces the amount of interference emitted by an electrical apparatus while at the same time reducing its susceptibility to impaired performance due to electromagnetic effects.

Not only cables themselves but also all other components that are part of the installation must provide shielding characteristics. As passive components, cable glands must ensure that the quality of the shielding at sensitive interconnection points remains intact and that there are no losses due to the shielding. For this reason, it's necessary to not only use a maximally shielded cable but also add EMC-compliant cable glands. Although there is no separate EMC standard for these components, they play a large contribution towards making it possible to meet the EMC characteristics prescribed by manufacturers.

The effect of cable shielding depends on the shielding material, the type of shielding and the connection to electrical ground. In order to achieve optimal effectiveness, the shielding must be connected on both sides of ground through a connection with both low resistivity and low

inductance. In other words, it must be led to the chassis wall through the shortest possible route and with a large contact surface. When subject to vibrations, a good contact must not result in an increased transfer resistance. In practice, these requirements can only be fulfilled if the connection can be installed simply and without special tools.

With four different EMC-compatible cable glands, AGRO offers its customers the appropriate product and the ideal types of contact for each type of application. With the new Progress **EMC easyCONNECT Brass** cable gland (see pages 6/7), contact is established through an innovative spring clip. Furthermore, AGRO offers the following proven series of products:

- **Progress EMC Rapid Brass** (see pages 8/9)
- **Progress EMC Brass** (see pages 10/11)
- **Progress Series 85 Brass** (see pages 12/13)

All these product lines stand out due to their easy assembly. Furthermore, the renowned Swiss EMC laboratory MONTENA EMC SA has certified AGRO cable glands for lowest transfer impedance and high current carrying capacity. Both are established criteria for the quality of shielding. In order to achieve a top grade, AGRO involves EMC specialists from the very beginning of new-product development.

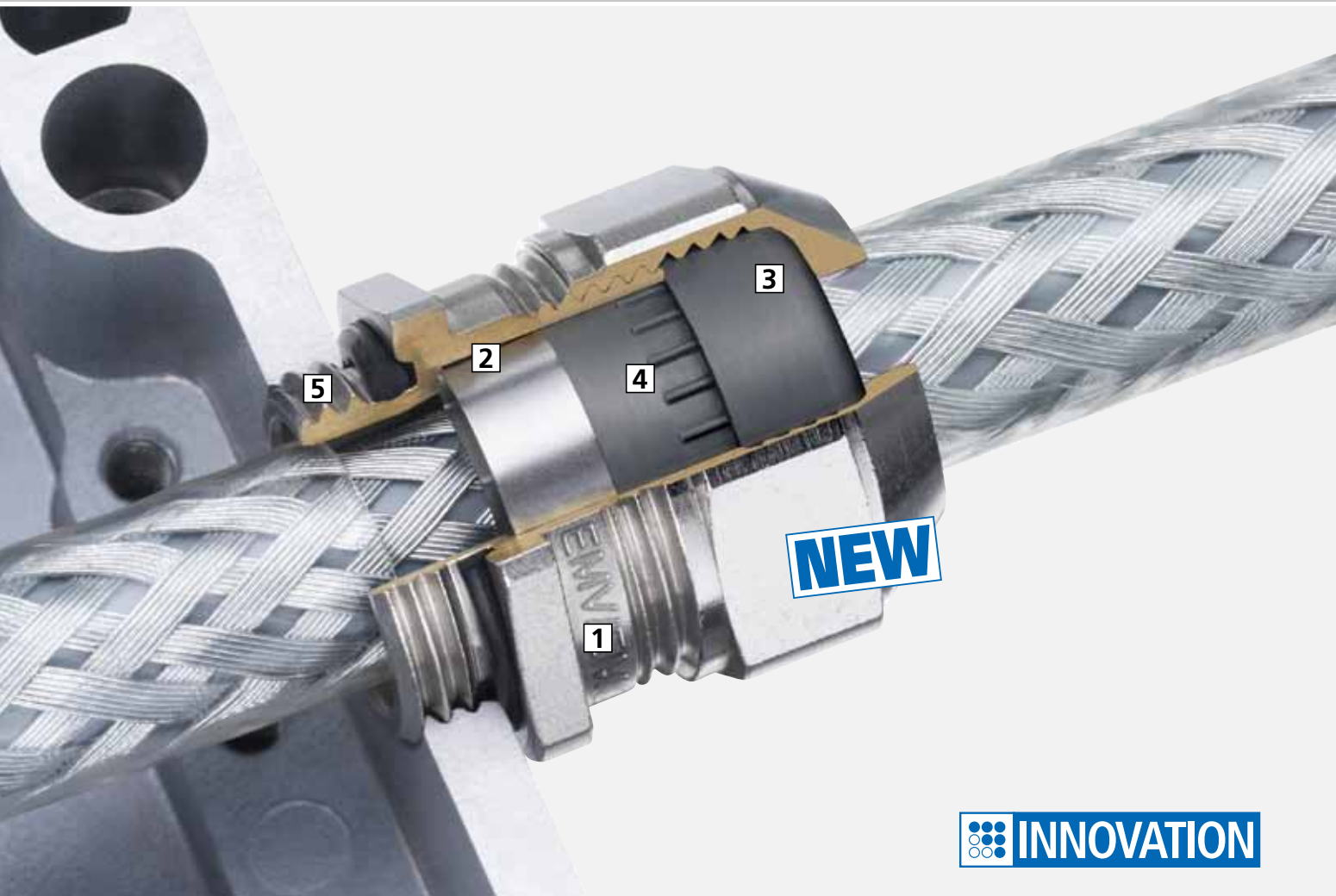

Progress® MS EMC easyCONNECT.

Quick, convenient installation thanks to an innovative contact spring.



The cable glands Progress® EMC easyCONNECT guarantees full control during installation and compensates for tolerances in shielding thicknesses to make a secure screened tap connection. The spring system provides for a very good contact of partially stripped shielding cables equally as well as for the contact of completely exposed cable shields which can be routed further.

1 Immediately recognisable

Thanks to the marking on the bottom section, the Progress® EMC easyCONNECT can be immediately identified by its EMC imprinting all around.

2 Optimal shield contact

The powerful, protective clamping of the cable shield guarantees excellent shield contact and provides for the smallest possible transfer impedance. The shape of the contact spring not only allows for a large clamping range to the shield nut also for easy disassembly without damaging the EMC braid.

3 Best possible sealing

Two-part sealing inserts can be adapted to the existing cable diameter on site in just seconds and guarantee perfect sealing in compliance with IP 68 and IP 69K.

4 High resistance to torsion

The integrated retaining grooves in the lower part and in the sealing insert grant against twisting.

5 Short or long entry threads

Short or long entry threads in metric or Pg types allow secure anchoring of the cable gland with or without an EMC locknut.



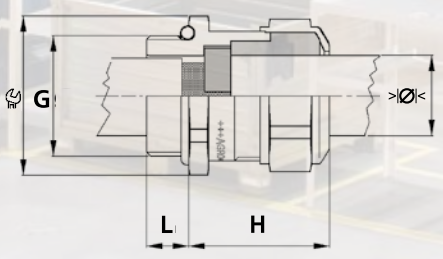

Material: Nickel-plated brass
Contact spring: Spring steel 1.4310
Seals: TPE
O-ring: NBR
Strain relief: According to EN 50262, Ver. A
Temperature range: -40°C / +100°C
Protection class: IP 68 / IP 69K

Short entry thread metric

| G | >Ø< mm | mm | H mm | L mm | Art.-No. | |
|---------|-----------|----|---------|---------|-------------|----|
| M12x1.5 | 3.5-5.0 | 15 | 22 | 5 | 1083.12.050 | 50 |
| M12x1.5 | 5.0-6.5 | 15 | 22 | 5 | 1083.12.065 | 50 |
| M16x1.5 | 6.0-10.5 | 18 | 25 | 5 | 1083.17 | 50 |
| M20x1.5 | 8.0-15.0 | 24 | 27 | 6 | 1083.20 | 50 |
| M25x1.5 | 12.5-20.5 | 30 | 33 | 7 | 1083.25 | 25 |
| M32x1.5 | 17.0-25.5 | 36 | 33 | 8 | 1083.32 | 25 |

Long entry thread metric

| G | >Ø< mm | mm | H mm | L mm | Art.-No. | |
|---------|-----------|----|---------|---------|-------------|----|
| M12x1.5 | 3.5-5.0 | 15 | 22 | 10 | 1183.12.050 | 50 |
| M12x1.5 | 5.0-6.5 | 15 | 22 | 10 | 1183.12.065 | 50 |
| M16x1.5 | 6.0-10.5 | 18 | 25 | 10 | 1183.17 | 50 |
| M20x1.5 | 8.0-15.0 | 24 | 27 | 10 | 1183.20 | 50 |
| M25x1.5 | 12.5-20.5 | 30 | 33 | 11 | 1183.25 | 25 |
| M32x1.5 | 17.0-25.5 | 36 | 33 | 13 | 1183.32 | 25 |

- Dimension M12 available only with one-piece sealing insert
- Approvals in preparation

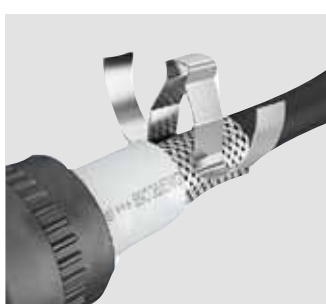

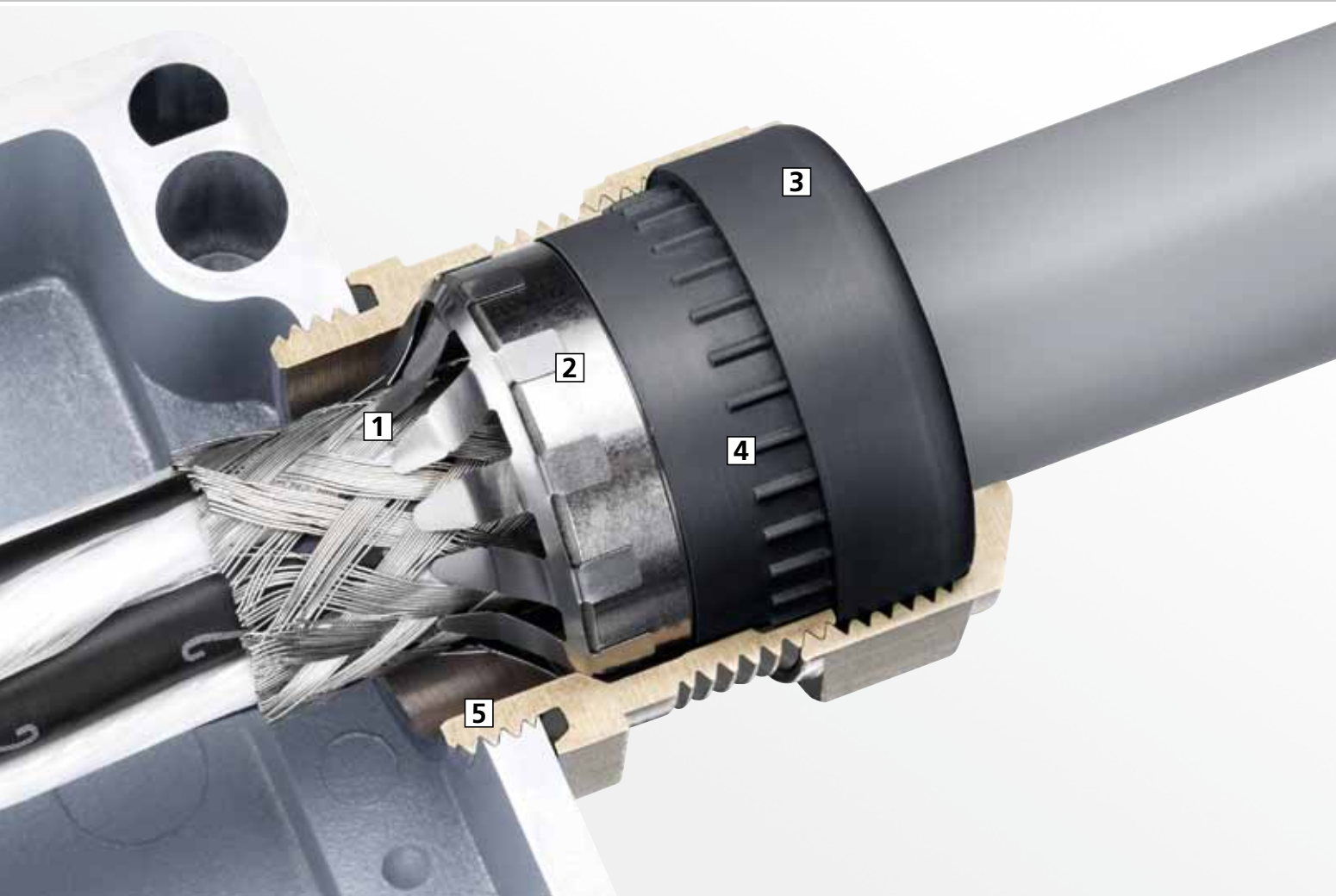

Progress® MS EMC Rapid.

For quick assembly.



The screw connection with two contact options. An integrated contact disc allows for easy and fast contact to the shield of partially stripped cables as well as of fully stripped cables which shields are being extended.

1 Low contact resistance

The flexible tongues on the contact disc, with their large surface area, maximise the gripping surface on the braided shield.

2 Flexible terminating methods

If a 360° contact is required, the contact disc can be extruded and the trimmed shield can be connected to the contact bushing.

2 Continuous contract pressure

The interlocking "sealing insert/contact sleeve" combination ensures that the contact washer continually presses on the bottom part.

3 Perfect sealing

Inner contours matched to the sealing insert ensure a targeted deformation of the insert and thus guarantee its tightness in compliance with protection class IP 68 / IP 69K.

4 High resistance to torsion

The integrated retaining grooves in the lower part and in the sealing insert grant against twisting.

5 Metric or Pg entry threads

Long or short entry threads metric or Pg can be screwed into existing threaded openings or be used with EMC locknuts.



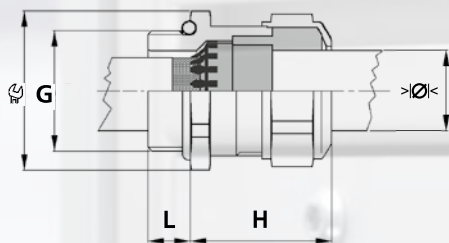

Material: Nickel-plated brass
Contact sleeve: Nickel-plated brass
Contact washer: Stainless steel A2
Seals: TPE
O-ring: NBR
Strain relief: According to EN 50262, Ver. A
Temperature range: -40°C / +100°C
Protection class: IP 68 / IP 69K

| Short entry thread metric | | | | | | |
|---------------------------|-------------|----|---------|---------|-------------|----|
| G | > Ø < mm | mm | H mm | L mm | Art.-No. | |
| M12x1.5 | 4.5-6.0 | 15 | 20 | 5 | 1081.12.060 | 50 |
| M12x1.5 | 6.0-7.5 | 15 | 20 | 5 | 1081.12.075 | 50 |
| M16x1.5 | 6.0-8.0 | 18 | 23 | 5 | 1081.17.080 | 50 |
| M16x1.5 | 8.0-10.0 | 18 | 25 | 5 | 1081.17.100 | 50 |
| M20x1.5 | 8.0-11.0 | 24 | 25 | 6 | 1081.20.110 | 50 |
| M20x1.5 | 11.0-14.0 | 24 | 27 | 6 | 1081.20.140 | 50 |
| M25x1.5 | 13.0-16.0 | 30 | 30 | 7 | 1081.25.160 | 25 |
| M25x1.5 | 16.0-19.0 | 30 | 33 | 7 | 1081.25.190 | 25 |
| M32x1.5 | 18.0-21.0 | 36 | 32 | 8 | 1081.32.210 | 25 |
| M32x1.5 | 21.0-25.0 | 36 | 32 | 8 | 1081.32.250 | 25 |

| Long entry thread metric | | | | | | |
|--------------------------|-------------|----|---------|---------|-------------|----|
| G | > Ø < mm | mm | H mm | L mm | Art.-No. | |
| M12x1.5 | 4.5-6.0 | 15 | 20 | 10 | 1181.12.060 | 50 |
| M12x1.5 | 6.0-7.5 | 15 | 20 | 10 | 1181.12.075 | 50 |
| M16x1.5 | 6.0-8.0 | 18 | 23 | 10 | 1181.17.080 | 50 |
| M16x1.5 | 8.0-10.0 | 18 | 25 | 10 | 1181.17.100 | 50 |
| M20x1.5 | 8.0-11.0 | 24 | 25 | 10 | 1181.20.110 | 50 |
| M20x1.5 | 11.0-14.0 | 24 | 27 | 10 | 1181.20.140 | 50 |
| M25x1.5 | 13.0-16.0 | 30 | 30 | 11 | 1181.25.160 | 25 |
| M25x1.5 | 16.0-19.0 | 30 | 33 | 11 | 1181.25.190 | 25 |
| M32x1.5 | 18.0-21.0 | 36 | 32 | 13 | 1181.32.210 | 25 |
| M32x1.5 | 21.0-25.0 | 36 | 32 | 13 | 1181.32.250 | 25 |

| Short entry thread Pg | | | | | | |
|-----------------------|-------------|----|---------|---------|-------------|----|
| G | > Ø < mm | mm | H mm | L mm | Art.-No. | |
| Pg 7 | 4.5-6.0 | 15 | 20 | 6 | 1081.07.060 | 50 |
| Pg 7 | 6.0-7.5 | 15 | 20 | 6 | 1081.07.075 | 50 |
| Pg 9 | 6.0-8.0 | 18 | 23 | 6 | 1081.09.080 | 50 |
| Pg 9 | 8.0-10.0 | 18 | 25 | 6 | 1081.09.100 | 50 |
| Pg 11 | 5.5-8.5 | 21 | 25 | 6 | 1081.11.085 | 50 |
| Pg 11 | 8.5-12.0 | 21 | 25 | 6 | 1081.11.120 | 50 |
| Pg 13 | 8.0-11.0 | 24 | 25 | 6 | 1081.13.110 | 50 |
| Pg 13 | 11.0-14.0 | 24 | 27 | 6 | 1081.13.140 | 50 |
| Pg 16 | 8.0-11.0 | 24 | 24 | 6 | 1081.16.110 | 50 |
| Pg 16 | 11.0-14.0 | 24 | 27 | 6 | 1081.16.140 | 50 |
| Pg 21 | 13.0-16.0 | 30 | 30 | 7 | 1081.21.160 | 25 |
| Pg 21 | 16.0-19.0 | 30 | 33 | 7 | 1081.21.190 | 25 |
| Pg 29 | 19.0-23.0 | 38 | 33 | 8 | 1081.29.230 | 25 |
| Pg 29 | 23.0-25.5 | 38 | 32 | 8 | 1081.29.255 | 25 |

| Long Entry thread Pg | | | | | | |
|----------------------|-------------|----|---------|---------|-------------|----|
| G | > Ø < mm | mm | H mm | L mm | Art.-No. | |
| Pg 7 | 4.5-6.0 | 15 | 20 | 10 | 1181.07.060 | 50 |
| Pg 7 | 6.0-7.5 | 15 | 20 | 10 | 1181.07.075 | 50 |
| Pg 9 | 6.0-8.0 | 18 | 23 | 10 | 1181.09.080 | 50 |
| Pg 9 | 8.0-10.0 | 18 | 25 | 10 | 1181.09.100 | 50 |
| Pg 11 | 5.5-8.5 | 21 | 25 | 10 | 1181.11.085 | 50 |
| Pg 11 | 8.5-12.0 | 21 | 25 | 10 | 1181.11.120 | 50 |
| Pg 13 | 8.0-11.0 | 24 | 25 | 10 | 1181.13.110 | 50 |
| Pg 13 | 11.0-14.0 | 24 | 27 | 10 | 1181.13.140 | 50 |
| Pg 16 | 8.0-11.0 | 24 | 24 | 10 | 1181.16.110 | 50 |
| Pg 16 | 11.0-14.0 | 24 | 27 | 10 | 1181.16.140 | 50 |
| Pg 21 | 13.0-16.0 | 30 | 30 | 12 | 1181.21.160 | 25 |
| Pg 21 | 16.0-19.0 | 30 | 33 | 12 | 1181.21.190 | 25 |
| Pg 29 | 19.0-23.0 | 38 | 33 | 12 | 1181.29.230 | 25 |
| Pg 29 | 23.0-25.5 | 38 | 32 | 12 | 1181.29.255 | 25 |



Progress® MS EMC.

Constant contact quality with lowest transfer impedance.



Progress EMC cable glands made of brass and with the time-proven contact sleeve make 360° contact with braided shield which terminates at the cable gland. The decisive edge geometry of the contact sleeve prevents any shearing of the braided shield.

5 Short or long entry threads

Short or long entry threads in metric or Pg types allow secure anchoring of the cable gland with or without an EMC locknut.

1 Low contact resistance

The immense 360° contact surface ensures low contact resistance.

2 Permanent contact pressure

The interlocking “sealing insert/contact sleeve” combination ensures permanent contact pressure of the braided shield against the lower part.

3 Optimal sealing and high temperature stability

Inner contours matched to the sealing insert ensure a targeted deformation of the insert and thus guarantee its tightness in compliance with protection class IP 68 / IP 69K. For applications at +200°C, FPM sealing inserts are available.

4 High resistance to torsion

The integrated retaining grooves in the lower part and in the sealing insert grant against twisting.



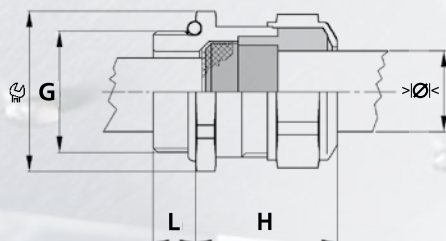

Material: Nickel-plated brass
Contact sleeve: Nickel-plated brass
Seals: TPE
O-ring: NBR
Strain relief: According to EN 50262, Ver. A
Temperature range: -40°C / +100°C
Protection class: IP 68

Short entry thread metric

| G | >Ø< mm | mm | H mm | L mm | Art.-No. | |
|------------------------|-----------|-----|---------|---------|-------------|----|
| M 8x1.25 ¹⁾ | 2.5-3.5 | 11 | 14 | 5 | 1080.08.035 | 50 |
| M 8x1.25 ¹⁾ | 3.0-4.0 | 11 | 14 | 5 | 1080.08.040 | 50 |
| M10x1.5 ¹⁾ | 3.0-4.0 | 13 | 15 | 5 | 1080.10.040 | 50 |
| M10x1.5 ¹⁾ | 4.0-6.0 | 13 | 15 | 5 | 1080.10.060 | 50 |
| M12x1.5 | 4.5-6.0 | 15 | 17 | 5 | 1080.12.060 | 50 |
| M12x1.5 | 6.0-7.5 | 15 | 17 | 5 | 1080.12.075 | 50 |
| M16x1.5 | 6.0-8.0 | 18 | 20 | 5 | 1080.17.080 | 50 |
| M16x1.5 | 8.0-10.0 | 18 | 22 | 5 | 1080.17.100 | 50 |
| M20x1.5 | 8.0-11.0 | 24 | 21 | 6 | 1080.20.110 | 50 |
| M20x1.5 | 11.0-14.0 | 24 | 23 | 6 | 1080.20.140 | 50 |
| M25x1.5 | 13.0-16.0 | 30 | 25 | 7 | 1080.25.160 | 25 |
| M25x1.5 | 16.0-19.0 | 30 | 28 | 7 | 1080.25.190 | 25 |
| M32x1.5 | 18.0-21.0 | 36 | 29 | 8 | 1080.32.210 | 25 |
| M32x1.5 | 21.0-25.0 | 36 | 29 | 8 | 1080.32.250 | 25 |
| M40x1.5 | 24.0-28.5 | 46 | 31 | 8 | 1080.40.285 | 10 |
| M40x1.5 | 28.5-32.0 | 46 | 31 | 8 | 1080.40.320 | 10 |
| M50x1.5 | 33.0-37.0 | 55 | 34 | 9 | 1080.50.370 | 10 |
| M50x1.5 | 37.0-41.0 | 55 | 34 | 9 | 1080.50.410 | 10 |
| M63x1.5 | 40.0-46.0 | 70 | 37 | 10 | 1080.63.460 | 5 |
| M63x1.5 | 46.0-50.0 | 70 | 37 | 10 | 1080.63.500 | 5 |
| M75x1.5 | 50.0-56.0 | 80 | 40 | 11 | 1080.75.560 | 1 |
| M80x2.0 | 56.0-65.0 | 95 | 45 | 18 | 1080.80.650 | 1 |
| M85x2.0 | 63.0-70.0 | 95 | 45 | 18 | 1080.85.700 | 1 |
| M95x2.0 | 68.0-75.0 | 110 | 52 | 20 | 1080.95.750 | 1 |

1) Metric coarse-pitch thread

Short entry thread Pg

| G | >Ø< mm | mm | H mm | L mm | Art.-No. | |
|-------|-----------|----|---------|---------|-------------|----|
| Pg 7 | 4.5-6.0 | 15 | 17 | 6 | 1080.07.060 | 50 |
| Pg 7 | 6.0-7.5 | 15 | 17 | 6 | 1080.07.075 | 50 |
| Pg 9 | 6.0-8.0 | 18 | 20 | 6 | 1080.09.080 | 50 |
| Pg 9 | 8.0-10.0 | 18 | 22 | 6 | 1080.09.100 | 50 |
| Pg 11 | 5.5-8.5 | 21 | 21 | 6 | 1080.11.085 | 50 |
| Pg 11 | 8.5-12.0 | 21 | 21 | 6 | 1080.11.120 | 50 |
| Pg 13 | 8.0-11.0 | 24 | 21 | 6 | 1080.13.110 | 50 |
| Pg 13 | 11.0-14.0 | 24 | 23 | 6 | 1080.13.140 | 50 |
| Pg 16 | 8.0-11.0 | 24 | 21 | 6 | 1080.16.110 | 50 |
| Pg 16 | 11.0-14.0 | 24 | 23 | 6 | 1080.16.140 | 50 |
| Pg 21 | 13.0-16.0 | 30 | 25 | 7.5 | 1080.21.160 | 25 |
| Pg 21 | 16.0-19.0 | 30 | 28 | 7.5 | 1080.21.190 | 25 |
| Pg 29 | 19.0-23.0 | 38 | 29 | 8 | 1080.29.230 | 25 |
| Pg 29 | 23.0-25.5 | 38 | 29 | 8 | 1080.29.255 | 25 |
| Pg 36 | 25.0-30.5 | 50 | 32 | 8 | 1080.36.305 | 10 |
| Pg 36 | 30.5-35.0 | 50 | 32 | 8 | 1080.36.350 | 10 |
| Pg 42 | 33.0-37.0 | 55 | 34 | 10 | 1080.42.370 | 10 |
| Pg 42 | 37.0-41.0 | 55 | 34 | 10 | 1080.42.410 | 10 |
| Pg 48 | 39.0-43.0 | 65 | 37 | 11 | 1080.48.430 | 10 |
| Pg 48 | 43.0-46.5 | 65 | 37 | 11 | 1080.48.465 | 10 |

1) Metric coarse-pitch thread

Long entry thread metric

| G | >Ø< mm | mm | H mm | L mm | Art.-No. | |
|------------------------|-----------|----|---------|---------|-------------|----|
| M 8x1.25 ¹⁾ | 2.5-3.5 | 11 | 14 | 10 | 1180.08.035 | 50 |
| M 8x1.25 ¹⁾ | 3.0-4.0 | 11 | 14 | 10 | 1180.08.040 | 50 |
| M10x1.5 ¹⁾ | 3.0-4.0 | 13 | 15 | 10 | 1180.10.040 | 50 |
| M10x1.5 ¹⁾ | 4.0-6.0 | 13 | 15 | 10 | 1180.10.060 | 50 |
| M12x1.5 | 4.5-6.0 | 15 | 17 | 10 | 1180.12.060 | 50 |
| M12x1.5 | 6.0-7.5 | 15 | 17 | 10 | 1180.12.075 | 50 |
| M16x1.5 | 6.0-8.0 | 18 | 20 | 10 | 1180.17.080 | 50 |
| M16x1.5 | 8.0-10.0 | 18 | 22 | 10 | 1180.17.100 | 50 |
| M20x1.5 | 8.0-11.0 | 24 | 21 | 10 | 1180.20.110 | 50 |
| M20x1.5 | 11.0-14.0 | 24 | 23 | 10 | 1180.20.140 | 50 |
| M25x1.5 | 13.0-16.0 | 30 | 25 | 11 | 1180.25.160 | 25 |
| M25x1.5 | 16.0-19.0 | 30 | 28 | 11 | 1180.25.190 | 25 |
| M32x1.5 | 18.0-21.0 | 36 | 29 | 13 | 1180.32.210 | 25 |
| M32x1.5 | 21.0-25.0 | 36 | 29 | 13 | 1180.32.250 | 25 |
| M40x1.5 | 24.0-28.5 | 46 | 31 | 13 | 1180.40.285 | 10 |
| M40x1.5 | 28.5-32.0 | 46 | 31 | 13 | 1180.40.320 | 10 |
| M50x1.5 | 33.0-37.0 | 55 | 34 | 14 | 1180.50.370 | 10 |
| M50x1.5 | 37.0-41.0 | 55 | 34 | 14 | 1180.50.410 | 10 |
| M63x1.5 | 40.0-46.0 | 70 | 37 | 14 | 1180.63.460 | 5 |
| M63x1.5 | 46.0-50.0 | 70 | 37 | 14 | 1180.63.500 | 5 |

1) Metric coarse-pitch thread

Long entry thread Pg

| G | >Ø< mm | mm | H mm | L mm | Art.-No. | |
|-------|-----------|----|---------|---------|-------------|----|
| Pg 7 | 4.5-6.0 | 15 | 17 | 10 | 1180.07.060 | 50 |
| Pg 7 | 6.0-7.5 | 15 | 17 | 10 | 1180.07.075 | 50 |
| Pg 9 | 6.0-8.0 | 18 | 20 | 10 | 1180.09.080 | 50 |
| Pg 9 | 8.0-10.0 | 18 | 22 | 10 | 1180.09.100 | 50 |
| Pg 11 | 5.5-8.5 | 21 | 21 | 10 | 1180.11.085 | 50 |
| Pg 11 | 8.5-12.0 | 21 | 21 | 10 | 1180.11.120 | 50 |
| Pg 13 | 8.0-11.0 | 24 | 21 | 10 | 1180.13.110 | 50 |
| Pg 13 | 11.0-14.0 | 24 | 23 | 10 | 1180.13.140 | 50 |
| Pg 16 | 8.0-11.0 | 24 | 21 | 10 | 1180.16.110 | 50 |
| Pg 16 | 11.0-14.0 | 24 | 23 | 10 | 1180.16.140 | 50 |
| Pg 21 | 13.0-16.0 | 30 | 25 | 12 | 1180.21.160 | 25 |
| Pg 21 | 16.0-19.0 | 30 | 28 | 12 | 1180.21.190 | 25 |
| Pg 29 | 19.0-23.0 | 38 | 29 | 12 | 1180.29.230 | 25 |
| Pg 29 | 23.0-25.5 | 38 | 29 | 12 | 1180.29.255 | 25 |
| Pg 36 | 25.0-30.5 | 50 | 32 | 15 | 1180.36.305 | 10 |
| Pg 36 | 30.5-35.0 | 50 | 32 | 15 | 1180.36.350 | 10 |
| Pg 42 | 33.0-37.0 | 55 | 34 | 15 | 1180.42.370 | 10 |
| Pg 42 | 37.0-41.0 | 55 | 34 | 15 | 1180.42.410 | 10 |
| Pg 48 | 39.0-43.0 | 65 | 37 | 15 | 1180.48.430 | 10 |
| Pg 48 | 43.0-46.5 | 65 | 37 | 15 | 1180.48.465 | 10 |

1) Metric coarse-pitch thread



Progress® MS EMC Series 85.

Concentric screened tap connection for high leakage currents.



Cable glands Progress® EMC Series 85 made of brass provide an especially low-impedance connection between the braided shield and the metal housing and a safe cable routing.

5 Metric or Pg entry threads

Progress EMC Series 85 cable glands with metric or Pg entry threads can be screwed into existing threaded openings or be used with EMC locknuts.

1 Optimal shield contact

The connector piece, which is secured with the help of large wrenching surfaces, enables perfect contact of the braided shield by means of a collet chuck with segments that slide together around 360°. The copper tap grants equal transmission of the compression power.

2 Highest leakage currents

The massive collet guarantees a concentric, low-impedance screened tap connection and handles leakage currents of up to 1,600 A continuous – and short term to 3 kA.

3 Great flexibility

Two-part sealing inserts can be adapted to the existing cable diameter on site in just seconds.

4 Perfect sealing

Inner contours matched to the sealing insert ensure a targeted deformation of the insert and thus guarantee its tightness in compliance with protection class IP 68 / IP 69K.



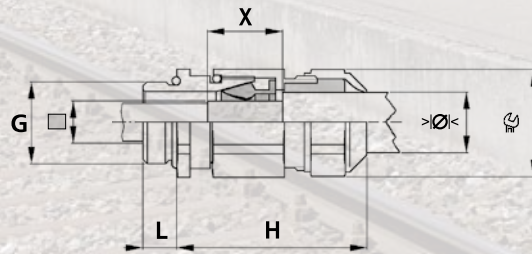

Material: Nickel-plated brass
Seals: TPE
O-ring: NBR
Strain relief: According to EN 50262, Ver. A
Temperature range: -40°C / +100°C
Protection class: IP 68 / IP 69K

Entry thread metric

| G | >Ø< mm | >■< mm | ⌀ mm | H mm | L mm | X mm | Art.-Nr. |  |
|---------|-----------|-----------|---------|---------|---------|---------|----------------|---|
| M16x1.5 | 4.5-6.0 | 3.0-4.5 | 18 | 40 | 6 | 14 | 1000.17.85.045 | 25 |
| M16x1.5 | 6.0-10.5 | 4.5-8.0 | 18 | 42 | 8 | 16 | 1000.17.85.080 | 25 |
| M16x1.5 | 8.0-15.0 | 7.5-10.0 | 24 | 47 | 8 | 20 | 1000.17.85.100 | 25 |
| M20x1.5 | 8.0-15.0 | 7.5-12.0 | 24 | 47 | 8 | 20 | 1000.20.85.120 | 25 |
| M20x1.5 | 12.5-20.5 | 10.0-14.0 | 30 | 59 | 8 | 21 | 1000.20.85.140 | 20 |
| M25x1.5 | 12.5-20.5 | 10.0-16.0 | 30 | 59 | 8 | 21 | 1000.25.85.160 | 20 |
| M25x1.5 | 17.0-25.5 | 14.0-19.0 | 36 | 66 | 8 | 24 | 1000.25.85.190 | 25 |
| M32x1.5 | 17.0-25.5 | 14.0-22.0 | 36 | 66 | 10 | 24 | 1000.32.85.220 | 25 |
| M32x1.5 | 24.0-33.0 | 21.0-25.0 | 46 | 68 | 10 | 24 | 1000.32.85.250 | 5 |
| M40x1.5 | 24.0-33.0 | 21.0-30.0 | 46 | 68 | 12 | 24 | 1000.40.85.300 | 5 |
| M50x1.5 | 33.0-42.0 | 29.0-38.0 | 55 | 77 | 13 | 25 | 1000.50.85.380 | 5 |
| M63x1.5 | 33.0-42.0 | 29.0-38.0 | 70/55 | 77 | 15 | 25 | 1000.63.85.380 | 5 |
| M63x1.5 | 40.0-52.0 | 35.0-44.0 | 70 | 78 | 15 | 26 | 1000.63.85.440 | 1 |





Entry thread Pg

| G | >Ø< mm | >■< mm | ⌀ mm | H mm | L mm | X mm | Art.-Nr. |  |
|-------|-----------|-----------|---------|---------|---------|---------|----------------|---|
| Pg 11 | 6.0-10.5 | 4.5-8.0 | 21/18 | 42 | 8 | 16 | 1000.11.85.080 | 25 |
| Pg 11 | 8.0-15.0 | 7.5-12.0 | 24 | 47 | 8 | 20 | 1000.11.85.120 | 25 |
| Pg 16 | 8.0-15.0 | 7.5-12.0 | 24 | 47 | 8 | 20 | 1000.16.85.120 | 25 |
| Pg 16 | 12.5-20.5 | 10.0-15.0 | 30 | 59 | 8 | 21 | 1000.16.85.150 | 25 |
| Pg 21 | 12.5-20.5 | 10.0-16.0 | 30 | 59 | 8 | 21 | 1000.21.85.160 | 20 |
| Pg 21 | 17.0-25.5 | 14.0-19.0 | 36 | 66 | 8 | 24 | 1000.21.85.190 | 25 |
| Pg 29 | 17.0-25.5 | 14.0-22.0 | 38/36 | 66 | 10 | 24 | 1000.29.85.220 | 20 |
| Pg 29 | 24.0-33.0 | 21.0-25.0 | 46 | 68 | 10 | 24 | 1000.29.85.250 | 5 |

Further EMC products from our range

| | | | |
|---|---|---|---|
|  |  |  |  |
| EMC cable glands with anti-kink spring Art.-Nr. 1080...52... | Sealing inserts for high temperatures Art.-Nr. 1080...91... | Combined conduit glands with integrated cable gland Progress® EMC Art.-Nr. 1710.80... | EMC adapter Art.-Nr. 1165.84... |
|  |  |  |  |
| Combined EMC conduit glands for copper braidings Art.-Nr. 1165.80... | EMC Rapid with contact disc for increased safety Ex e II Art.-Nr. EX1081... | EMC with contact sleeve for increased safety Ex e II Art.-Nr. EX1080... | EMC with contact sleeve and clamps for increased safety Ex e II Art.-Nr. EX1803.80... |

On request, EMC can be delivered in the following designs

| | | | | |
|---|---|---|--|---|
|  |  |  |  |  |
| Short entry thread • metric • PG • NPT | Long entry thread • metric • PG • NPT | One-piece sealing insert | Two-piece sealing insert | Sealing inserts and o-rings for high temperature applications |

- Executions in stainless steel A2 (CrNi steel) available
- Executions in stainless and acid resistant steel A4 available

Accessories

| | | | |
|---|---|---|---|
|  |  |  |  |
| EMC lock nut nickel-plated brass with cutting teeth Art.-Nr. 80...85 | Grounding strap for cable glands Art.-Nr. 10...80.01 | Blind discs for cable glands Progress® Art.-Nr. 10...00.19 | Assembly tool for cable glands under cramped confines Art.-Nr.4800... |

Please find our complete product range in our catalogue "Cable Glands" or on our Website www.agro.ch.

| | Progress® nickel-plated brass | EMV easyCONNECT | EMV Rapid | EMV Standard | EMC Series 85 | EMC with anti-kink spring | EMC for high temperatures | Combination conduit glands with integrated cable glands | Combination EMC gland copper braidings | EMC adapter | EMC Accessories | EMC locknut with cutting teeth | Grounding strap |
|---|-------------------------------|-----------------|-----------|--------------|---------------|---------------------------|---------------------------|---|--|-------------|-----------------|--------------------------------|-----------------|
| Execution | | | | | | | | | | | | | |
| Compression technology | NEW | • | • | • | • | • | • | • | - | • | - | - | - |
| EMC tapping bonding technology | | | | | | | | | | | | | |
| Contact sleeve | | • | - | - | - | A | A | - | - | - | - | - | - |
| Contact clip | | - | • | - | - | A | A | - | - | - | - | - | - |
| Contact washer | | - | • | • | - | • | • | • | • | • | - | - | - |
| Collet | | - | - | - | • | - | A | - | - | - | - | - | - |
| Entry thread | | | | | | | | | | | | | |
| Entry thread, metric | | • | • | • | • | • | • | • | • | • | • | • | • |
| Entry thread, Pg | | A | • | • | A | • | • | • | A | • | • | • | • |
| Short entry thread (standard) | | • | • | - | • | • | • | A | A | - | - | - | - |
| Long entry thread | | • | • | - | A | A | • | • | • | • | - | - | - |
| Sealing insert | | | | | | | | | | | | | |
| for round cable | | • | • | • | • | • | • | • | • | • | - | - | - |
| for conduits | | - | - | - | - | - | - | • | • | • | - | - | - |
| 1-part sealing insert | | A | • | • | A | • | • | • | A | • | - | - | - |
| 2-part sealing insert | | • | - | - | • | - | - | - | - | - | - | - | - |
| standard sealing ring (TPE / NBR) | | • | • | • | • | • | - | • | - | • | - | - | - |
| FPM sealing insert | | A | A | • | A | A | • | A | - | A | - | - | - |
| Characteristics | | | | | | | | | | | | | |
| Strain relief | | • | • | • | • | • | • | • | - | • | - | - | - |
| Anti-kink protection | | - | - | - | - | • | - | - | - | - | - | - | - |
| Continuation of braided shield | | • | • | - | • | - | - | - | - | - | - | - | - |
| Without continuation of braided shield | | • | • | • | • | • | • | • | • | • | - | - | - |
| Extent of clamping range for the shield | | +++ | ++ | + | + | + | + | + | + | + | - | - | - |
| Minimal transfer impedance | | ++ | + | ++ | +++ | ++ | ++ | ++ | ++ | ++ | - | - | - |
| High leakage currents | | - | - | - | +++ | - | - | - | - | - | - | - | - |
| Can be dismantled without damaging the shield | | +++ | - | + | ++ | - | - | - | - | - | - | - | - |
| Easy installation (quick assembly) | | ++ | +++ | + | + | + | + | + | + | + | - | - | - |

- applicable / available
- not applicable / not available

+++ very well suited

++ well suited

+ suited

A upon request

Systems and solutions for professional cable routing.



Syntec® cable glands made of plastic or brass are the optimal solution for your daily installation tasks. The patented, unique lamellar technology always guarantees cable routing with excellent strain relief.



Progress® cable glands made of plastic or metal are proven aids for professional cable routing in industrial plants. The excellent compression technology ensures tight seals and strain relief which is exceptionally easy on cables.



Progress® EMC cable glands made of brass ensure a low-impedance connection between the braided shield and the metal chassis while maintaining secure cable routing.



Progress® Ex cable glands made of plastic or brass ensure secure cable routing even in potentially explosive environments.



Elbows and flanges to add changes of direction in switching cabinets and chassis.



Accessories: locknuts, reduction fittings, locking screws, ...

Technical information and advice

Please find additional information about products, system solutions and communication media on our website: www.agro.ch

For additional questions or information our technical staff will be available and would be pleased to talk with you.

AGRO phone: +41(0) 62 889 47 47 | AGRO eMail: info@agro.ch



AGRO AG | A KAISER COMPANY

Korbackerweg 7 · CH-5502 Hunzenschwil

Tel. +41(0)62 889 47 47 · Fax +41(0)62 889 47 50

www.agro.ch · info@agro.ch

... your quality-connection