



# MY NEW F45.

FEATURES, OPTIONS.



## WE INVENTED THE SLIDING TABLE SAW. NOW WE ARE REINVENTING IT.

*YOUR NEW ALTENDORF.*

The world has Wilhelm Altendorf to thank for the sliding table saw. His invaluable invention, which first saw the light of day in 1906, enabled users to make a straight trim cut in a plank – an essential precursor to the 90° crosscut – for the first time. Woodworkers all over the world have been reaping the benefits of this remarkable invention ever since, with more than 150 000 Altendorf machines sold worldwide to date. Unsurprisingly perhaps, the intervening years have also seen the Altendorf name become synonymous with the sliding table saw. The new generation redefines the Altendorf F45 all over again: new design, the latest technology, new ease of use and unrivalled precision. Enjoy your new Altendorf!

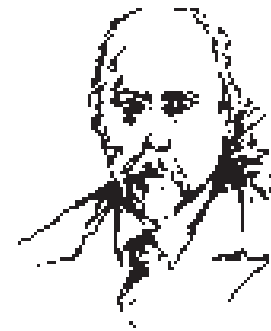



# CONTENTS

**04–05** The Altendorf principle

**06–07** Basic specification

**08–09** F 45 ProDrive control unit

**10–11** F 45 EvoDrive control unit

**12–13** F 45 ElmoDrive control unit

**14–15** Control units compared

**16–31** Options

**32–33** Technical specifications

**34–35** Altendorf services



The background of the advertisement is a hand-drawn technical sketch of a machine frame, likely a lathe. The drawing is done in black ink on a light-colored paper. It shows various components of the machine, including a bed, a headstock, and a tailstock. Dimensions are written in numbers, such as 300, 870, 1200, 400, 430, and 1300. There are also some handwritten notes and symbols, like '150' and '1200', which might represent specific measurements or design parameters. The overall style is that of a professional engineer's sketch.

## THERE IS STILL ONLY ONE F 45.

YOUR NEW ALTENDORF.

The new F 45 is a masterpiece of technology and design. The comprehensively redesigned machine frame combines absolutely unprecedented torsion resistance with extremely low levels of vibration, while the smooth front and clear foot space on the floor enable you to operate closer to the machine and the workpiece. The famously smooth-running sliding table, which has received a number of design tweaks, remains the undisputed benchmark for precision cutting and minimal maintenance. The crisp new industrial design underlines the distinctive quality of the Altendorf brand: Distinctive design meets timeless aesthetics – recognised with the iF design award 2016. Altendorf's new generation is unique in that we now have just the one model: the F 45. This one model, however, comes with a choice of three completely new control unit designs, every one of which enables you to control up to four axes from the centrally-positioned eye-level control panel. The only decision that remains for you to make is this: Which control unit shall it be?



YOUR NEW F 45.



CHOOSE YOUR CONTROL UNIT

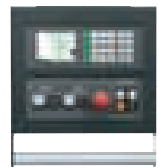

F 45 ProDrive

OR

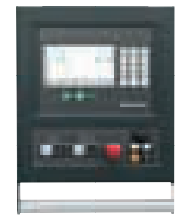

F 45 EvoDrive

OR



F 45 ElmoDrive

CHOOSE YOUR OPTIONAL EXTRAS



# OUTSTANDING DESIGN MEETS OUTSTANDING TECHNOLOGY.

---

## BASIC SPECIFICATION

---

- ▶ Motorised rise/fall and tilt adjustment (0–46°) for the main saw blade with automatic cutting height correction when saw blade tilted
  - ▶ Eye-level control unit, swivelling
  - ▶ Sliding table, table length 3 000 mm
  - ▶ Rip fence, manual adjustment using graduated scale, includes fine adjustment, cutting width 1 000 mm
  - ▶ Crosscut fence with fixed 90° angle, manual adjustment using graduated scale up to 3 200 mm
  - ▶ Maximum saw blade projection 150 mm, maximum saw blade diameter 450 mm
  - ▶ Motor rating basic specification, single speed (4 000 rpm)
  - ▶ AKE tool clamping system for the main saw blade
- 

---

## MACHINE IN BASIC SPECIFICATION WITH CONTROL UNIT

---

<b>M18150</b>	F 45 ProDrive
<b>M18151</b>	F 45 EvoDrive
<b>M18152</b>	F 45 ElmoDrive

---

*Every option is available with every control unit. The new F 45 is the first and hitherto only sliding table saw to offer you these options. There is only one thing we have decided for you in advance: that the control units will always be at eye level when you are working with the new F 45.*

 DESIGN  
AWARD  
2016



 ALTENDORF® F45

## F 45 PRODRIVE – CONTROL UP TO FOUR AXES AND MORE.

The swivel-mounted control unit offers unprecedented ease of use, clarity, safety and convenience. Even this entry-level option provides control of all four axes. All values and functions are displayed clearly on the screen, which has a 90 mm diagonal. Use the green keys to access the saw blade height and tilt functions (up to 46° in either direction) plus, depending on package configuration, the CNC rip fence, crosscut fence, scorer and VARIO (infinitely variable speed control between 2 000 and 6 000 rpm) options, the white data entry keys to enter the corresponding values. Obviously the control unit can only control the hardware you have installed, so choose precisely the configuration options you need for your Altendorf.





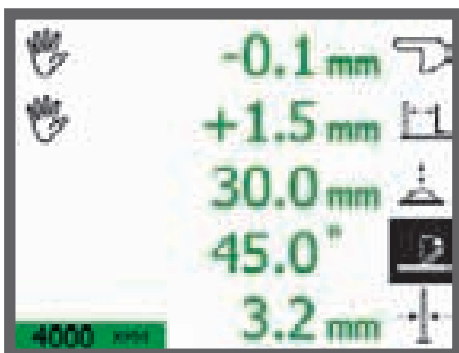

Machine in basic specification,  
saw blade tilted,  
manual dimension correction

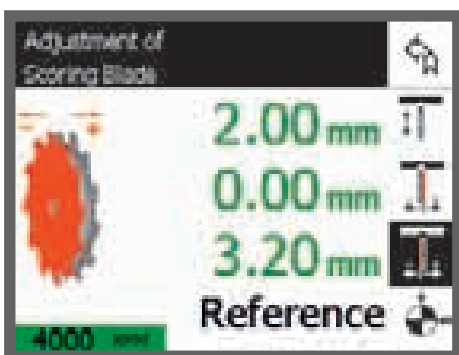

Configuring the three-axis scorer\*

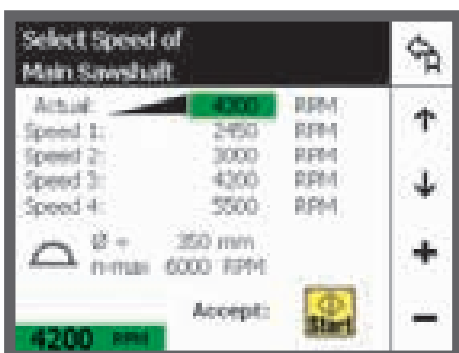

VARIO  
(infinitely variable speed control)\*

### F 45 ProDrive

- ▶ Motorised rise/fall and tilt adjustment (up to 46° to either side)\*  
for the main saw blade with automatic height correction and digital display
- ▶ Motorised rip fence adjustment\*
- ▶ Motorised adjustment of the UNO 90 CNC crosscut fence\*
- ▶ Automatic position correction for rip fence and crosscut fence when saw blade tilted
- ▶ Digital speed display or infinitely variable speed control (VARIO)\*
- ▶ Motorised scorer unit, two or three axes\*
- ▶ Continuous precision axis control using +/- keys\*
- ▶ Control of the vacuum clamping system in the sliding table\*
- ▶ Easy axis calibration
- ▶ Machine diagnostics
- ▶ Operating hours counter
- ▶ USB interface
- ▶ "Back" function to recall last set of dimensions entered
- ▶ Memory for 99 cutting programmes

### MACHINE IN BASIC SPECIFICATION WITH CONTROL UNIT

M18150 F 45 ProDrive

\*optional accessory

## F 45 EvoDrive – EFFICIENCY-BOOSTING FEATURES ALREADY ONBOARD.

The new F 45 EvoDrive has a 7" touch screen with separate keyboard for entering numerical dimension specifications. It can control up to four axes, including saw blade tilt to either side. What distinguishes it from the F 45 ProDrive is its pre-installed application technology: the F 45 EvoDrive defines inside and outside dimensions automatically from the material thickness data supplied, for example. It also brings you the pleasure of additional groove, incremental dimension and bevel rip features, which should simplify your work considerably – as, indeed, should the compound mitre function and the tool management system. The F 45 EvoDrive lets you store 999 programmes for rapid retrieval via the keyboard too. The green navigation keys enable you to find your way easily through the functions, go to the main menu or jump back a page. Another particularly useful feature is that the brightness of the display adjusts to suit different ambient lighting conditions to make sure you always have a good view of everything you need to be able to see. Try the F 45 EvoDrive and discover how we have already done much of the hard work for you!





Compound mitre



Bevel rip



Groove

### F 45 EvoDrive

- ▶ The F 45 EvoDrive includes all of the functions of the F 45 ProDrive control unit (pages 8+9) and more
- ▶ Automatic conversion of inside to outside dimensions for the rip fence and crosscut fence as a function of material thickness and tilt angle
- ▶ Compound mitre function with automatic calculation of missing angles/dimensions
- ▶ Enhanced tool management
  - Scorer position memory (three-axis scorer)\*
  - Storage of saw blade plate thickness and cutting width
  - Storage of main saw blade speed
  - Memory for a maximum of 100 saw blades
- ▶ Additional functions
  - Grooving: rip fence positioned automatically step by step to create the groove
  - Incremental dimensions: rip fence moves out or in automatically by a specified distance
  - Bevel rip: the rip fence is set automatically to cut away the required angle from strips pre-cut at 90 degrees, as a function of material thickness and tilt angle
  - Memory for 999 cutting programmes

### MACHINE IN BASIC SPECIFICATION WITH CONTROL UNIT

M18151 F 45 EvoDrive

\*optional accessory

## F 45 ElmoDrive – CONTROL TECHNOLOGY WITHOUT EQUAL.

The F 45 ElmoDrive incorporates the most advanced and comprehensive control technology in existence for sliding table saws. Positioned at eye level, it combines optimal ease of use and presentation with practical and ergonomic operation. The calculator, geometric shapes, compound mitre and tool management functions are easily accessed and clearly presented on the 12" touch screen. The F 45 ElmoDrive of course gives you motorised control of all axes and allows you to tilt the saw unit to either side. The lower part of the display can be used to store functions you return to regularly (in the manner of a PC desktop) for even more efficient operation. The F 45 ElmoDrive is the only control unit that can be linked with a cut optimisation package. All in all, nothing comes close to the F 45 ElmoDrive for control technology. Day after day after day.



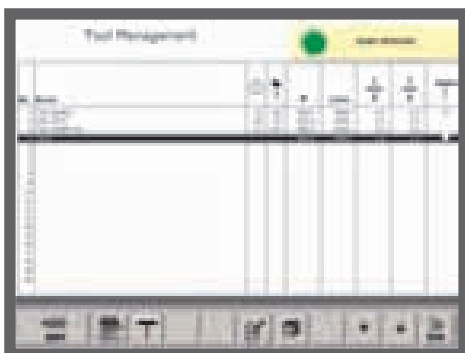

Tool management

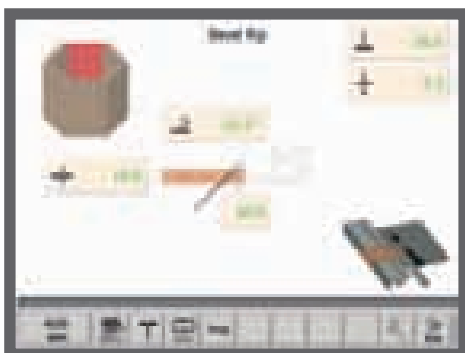

Bevel rip

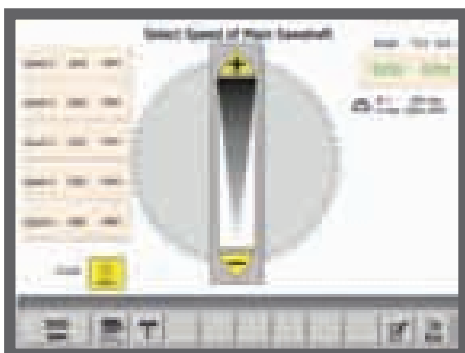

Rotational speed menu

---

### F 45 ElmoDrive

---

- ▶ The F 45 ElmoDrive includes all of the functions of the F 45 ProDrive and F 45 EvoDrive control units (pages 8–11) and more

---

- ▶ Calculator function, with results transferred to the relevant axes

---

- ▶ Geometric shapes with automatic calculation of missing angles/dimensions

---

- ▶ Mitre joints between pieces of different widths with automatic calculation of missing angles/dimensions

---

- ▶ Interface for connecting to a PC, for example to allow running of cut optimisation programmes\*

---

- ▶ Memory for 9999 cutting programmes

---

---

### MACHINE IN BASIC SPECIFICATION WITH CONTROL UNIT

---

<b>M18152</b>	F 45 ElmoDrive
---------------	----------------

---

\*optional accessory

## THE F45 CONTROL UNITS COMPARED.



F45 ProDrive



F45 EvoDrive



F45 ElmoDrive

OVERVIEW OF THE CONTROL UNITS*	F 45 ProDrive	F 45 EvoDrive	F 45 ElmoDrive
Main saw blade height adjustment	●	●	●
Main saw blade tilt adjustment, one-way	●	●	●
Main saw blade tilt adjustment, two-way	○	○	○
CNC rip fence	○	○	○
UNO 90 CNC crosscut fence	○	○	○
DUO 90/DUO Flex CNC crosscut-mitre fence	—	○	○
Vacuum table	○	○	○
TIP-SERVO-DRIVE	○	○	○
Programmes	99	999	9999
Inside/outside dimension function for rip fence	—	●	●
Inside/outside dimension function for crosscut fence	—	●	●
Tool management	—	100	100
Compound mitre	—	●	●
Groove/chain groove	—	●	●
Incremental dimension function for rip fence	—	●	●
Bevel cut with oversize allowance	—	●	●
Mitre joints between pieces of different widths	—	—	●
Geometric shapes	—	—	●
Calculator function	—	—	●
Job time recording	—	—	●
USB interface for programmes and data	●	●	●
Cut optimisation interface/link	—	—	○

● standard

○ option

— not included

\* if part of machine specification

## DRIVES: HIGH TORQUE WITH POWER TO SPARE.

**Drives for one-way tilt with manual speed adjustment.** The motors are manufactured specially to Altendorf's specifications and have been optimized for use in sliding table saws. They provide up to 20% more torque than conventional electric motors with no increase in power consumption. The three-speed units operate at 3000, 4000 and 5000rpm and are adjusted manually.

- M51050** 4kW (5.5HP) single speed
- M51100** 5.5kW (7.5HP) three speeds
- M51101** 7.5kW (10HP) three speeds
- M51102** 11kW (15HP) three speeds

**basic specification**

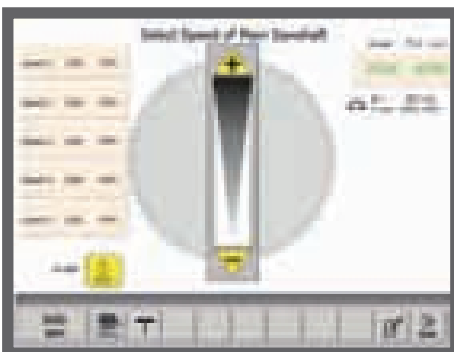

**VARIO drive for one-way tilt.** This drive offers infinitely variable speed control between 2000 and 6000rpm. Matching speed precisely to the material increases not just cutting quality, but also the service life of your saw blades, which, in turn, helps to reduce your costs.

- M51103** 5.5kW (7.5HP)
- M51104** 7.5kW (10HP)

**Extended cutting height for one-way tilt.** This option is fitted out for one-way tilt with a large extraction hood for a maximum saw blade diameter of 550mm and a saw blade projection of no greater than 204mm. The maximum saw blade diameter when used in combination with a scorer unit is 500mm, which corresponds to a cutting height of 179mm. Only in combination with a motor rated at least 5.5kW (7.5HP).

**M64080**

**Special voltages on request.**



## TWO-WAY TILT: ALWAYS PRACTICAL.

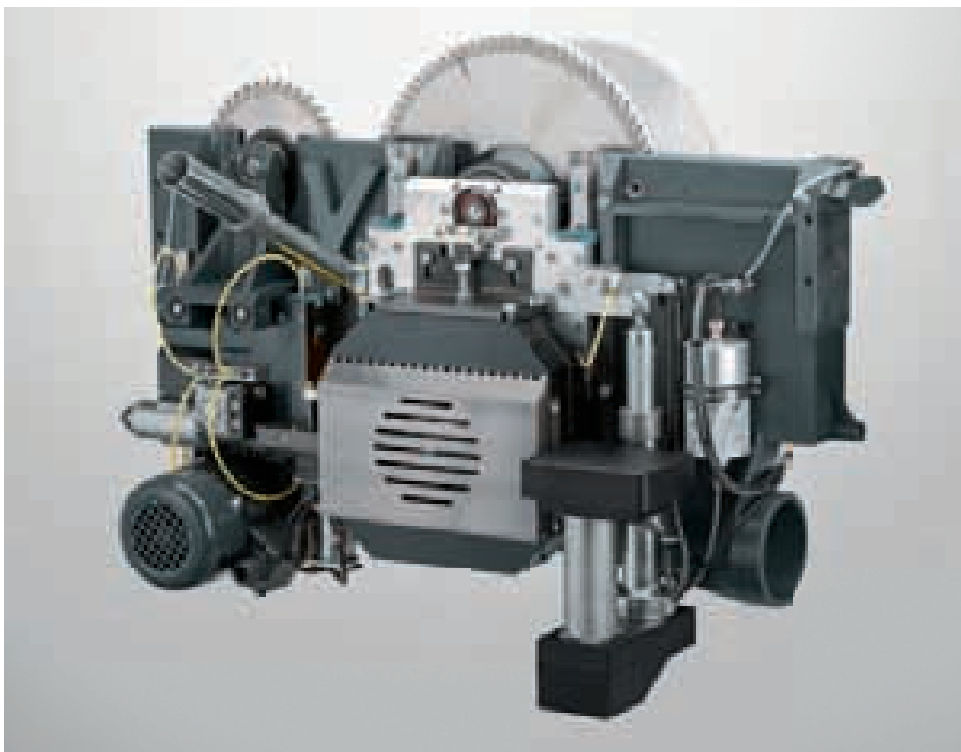

**Saw unit tilts up to 46° to either side.** The ability to tilt the saw unit up to 46° to either side makes the F45 an even more versatile cutting machine. There is no need to adjust the extraction hood either, as it simply follows the saw unit. The entire movement, from full tilt one way to full tilt the other, takes just 12 seconds. One of the main applications for the two-way tilt function is the sawing of internal mitres, which can be done easily and safely using the crosscut fence. Just as straightforward are simple bevel cuts and compound mitres. VARIO infinitely variable speed control (2 000–6 000 rpm) makes operation even faster and more user-friendly, while the extremely compact design of the synchronous motor allows it to be linked to the saw shaft with a rigid connection, eliminating at a stroke the potential for faults associated with indirect belt-based linkages. The advanced technology built into this motor means that it already satisfies the requirements for energy efficiency class IE4 and has an enormous power reserve in excess of 120%. The tilt adjustment feature, which is firmly anchored at the centre of mass of the saw unit, has already proven its mettle 10 000 times over in the one-way tilting F45: in short, it simply does not twist! The maintenance-free tilt quadrants use a tongue and groove connection system with automatic lubrication. The advanced technology built into this motor means that it already satisfies the requirements for energy efficiency class IE4.

**M18500** 5 kW (6.8 HP), peak power 11 kW, with VARIO

**M51059** Additional charge for 6.5 kW (8.8 HP), peak power 15 kW, with VARIO

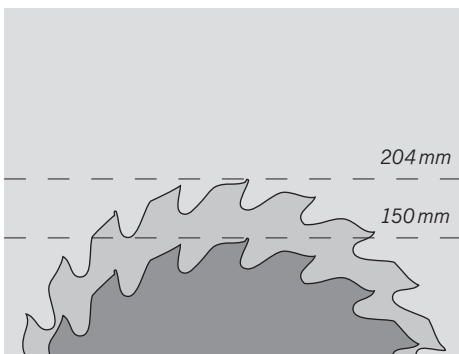

### Extended cutting height for two-way tilt.

The maximum saw blade projection of 204 mm is achieved with a saw blade diameter of 550 mm. We recommend you choose the more powerful 6.5 kW (8.8 HP) motor.

**M64079**



Special voltages on request.

## SCORER UNITS: CHIP-FREE AND SAFE.

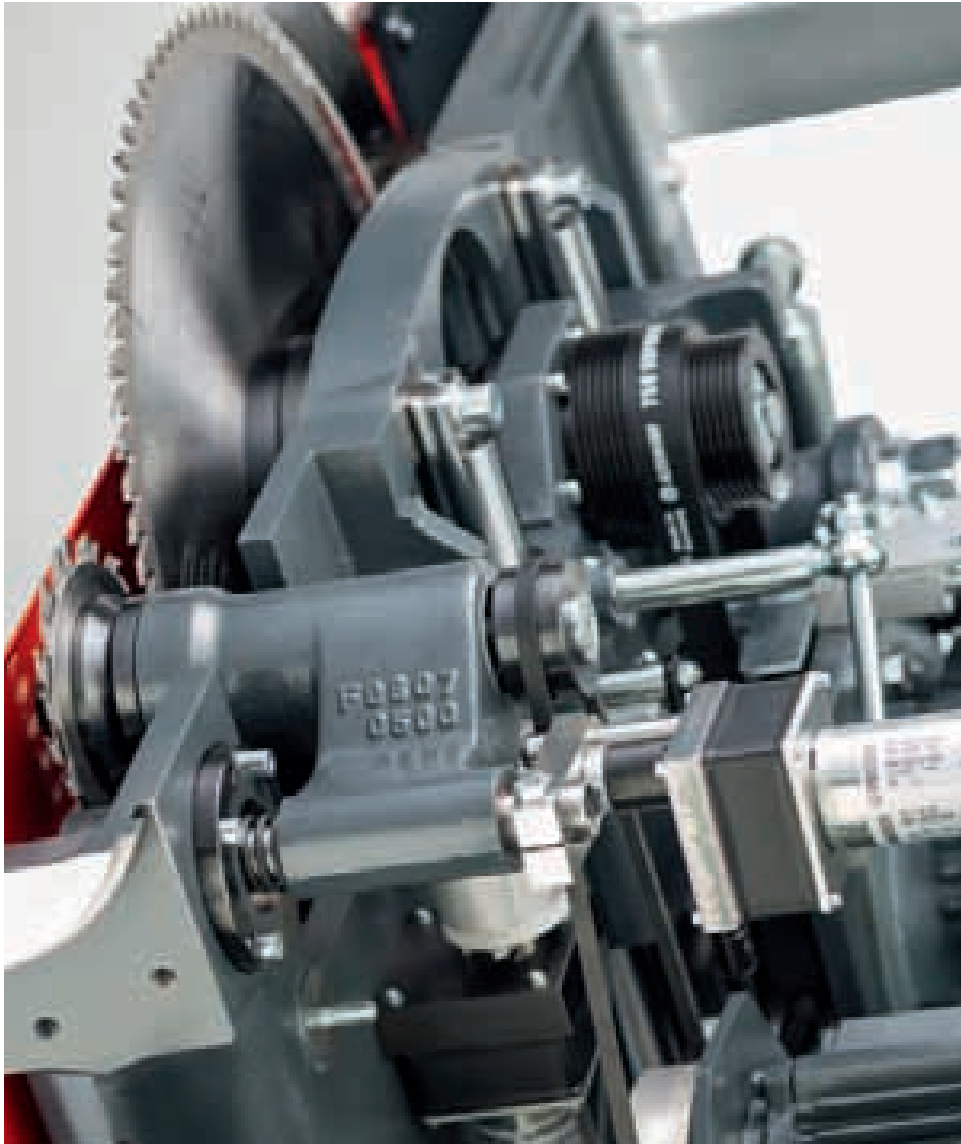

**Two-axis scorer unit.** With motorised vertical and lateral adjustment, programmable scorer blade height, rapid deploy and retract and 0.75 kW (1 HP) motor running at 8 200 rpm with one-way tilt or 6 000 rpm with two-way tilt. For retrofitting only to scorer-unit-ready machines.

**M24030** One-way tilt,  $\varnothing = 120$  mm

**M24034** Two-way tilt,  $\varnothing = 180$  mm

**M24038** Scorer-unit-ready upgrade

**Three-axis scorer unit (RAPIDO Plus).** With motorised vertical, lateral and cutting width adjustment, including saw blade, programmable scorer blade height, rapid deploy and retract, saw blade width display and 0.75 kW (1 HP) motor running at 8 200 rpm with one-way tilt or 6 000 rpm with two-way tilt. For retrofitting only to scorer-unit-ready machines.

**M24032** One-way tilt,  $\varnothing = 120$  mm

**M24036** Two-way tilt,  $\varnothing = 180$  mm

**M24038** Scorer-unit-ready upgrade



**RAPIDO scoring system.** The scorer ensures chip-free undersides when working with laminated panels. The RAPIDO system makes adjusting the cutting width straightforward and enables this step to be completed in no more than three minutes. Compared to working with shims, where you have to take the blade off the machine to alter its width, the RAPIDO saves up to 30 minutes, as the blade stays on the machine during adjustment. Adjustment is continuous and precise, so the RAPIDO can be fine-tuned to match the cutting width of any main blade. Range: 3–3.8 mm.

**M24031** One-way tilt,  $\varnothing = 120$  mm

**M24035** Two-way tilt,  $\varnothing = 180$  mm

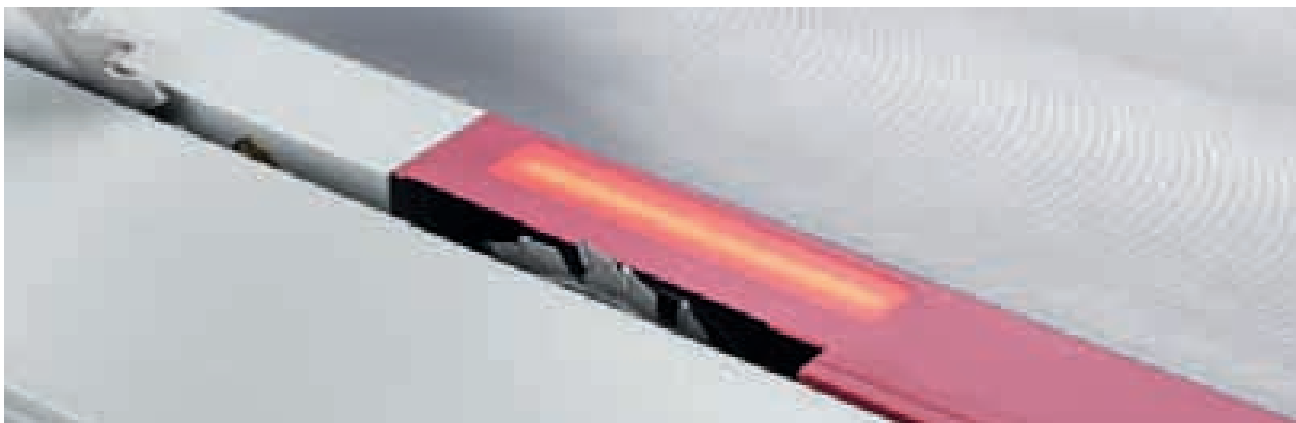

**LED illumination.** Particularly energy-efficient LEDs render the danger area around the scorer highly visible.

**M24037**

## ADMIRER FOR ITS SMOOTH RUNNING, PRECISION AND SAFETY.

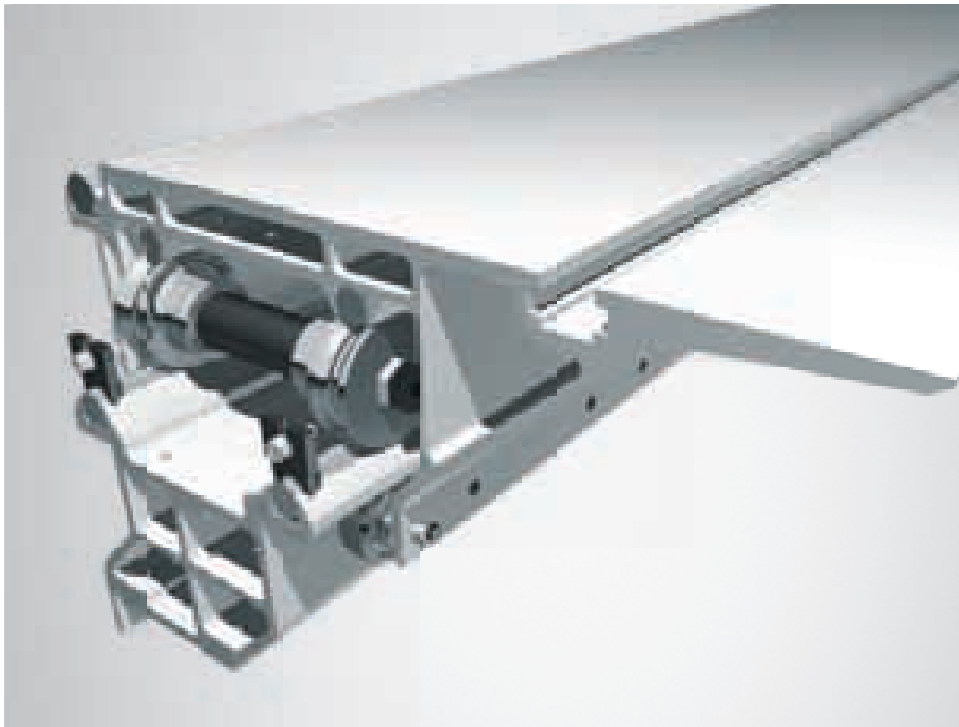

**Sliding table.** The Altendorf sliding table is renowned for its smooth, precise running. It is infinitely adjustable and can be locked in whatever position required. The large dumbbell rollers guide the moving table with absolute precision between the hard-chromed guide bars. And it retains this ease of movement even after decades of hard work, dust and dirt. The hollow multi-chamber design gives great torsion resistance and rigidity.

**M34201** Table length 2 250 mm

**M34203** Table length 3 000 mm

**M34204** Table length 3 200 mm

**M34205** Table length 3 400 mm

**M34206** Table length 3 800 mm, with floor support

**M34207** Table length 4 300 mm, with floor support

**M34208** Table length 5 000 mm, with floor support

**basic specification**

**M41010** table extension 840 mm

**M41011** table extension 1 200 mm

**M41012** table extension 1 600 mm, with leg

**M41013** table extension 2 000 mm, with leg

**basic specification**

**Sliding-table-mounted on/off switches: a practical option.** The on/off switches are always right where you need them, directly on the sliding table handle. The four buttons switch both the main and scoring blades on and off, saving time and improving safety. All switches can be operated as required either at the machine control panel or on the sliding table: there is no need to toggle specifically between the two.

**M37003** On/off switches on sliding table (not in combination with TIP-SERVO-DRIVE)





**Vacuum clamping system in the sliding table.** Altendorf is the first to apply proven vacuum clamping technology to sliding table saws. The system, which is integrated into the sliding table itself, has at its heart a powerful vacuum pump that generates a vacuum via pairs of suction grippers arranged in the sliding table. The individual suction areas along the sliding table can be controlled individually via the buttons, allowing you to adjust the vacuum so that it optimally suits the workpiece. Wooden, plastic and aluminium panels remain securely in position on the sliding table throughout even complex cuts such as angles, long mitres and cuts to an outside dimension. Another touch of a button is all it takes to release the workpiece. Vacuum clamping improves reliability, precision and convenience and helps to eliminate manual operating errors. All table lengths feature the same five pairs of suction grippers. Each pair can be activated separately. Additional pairs of suction grippers are available on request. Not compatible with TIP-SERVO-DRIVE.

**M64095**



**TIP-SERVO-DRIVE.** The motorised servo drive for the sliding table takes the physical strain off the operator's body, the back in particular, making it very easy to move even the heaviest of workpieces back and forth during cutting. The electronic sensor control handle responds to the lightest of touches, so you can maintain an upright and relaxed posture throughout the cutting operation. The TIP-SERVO-DRIVE cannot be used in combination with the on/off switches on sliding table option or the vacuum clamping in sliding table option.

**M35209**



**Pneumatic pressure beam.** This is an ideal solution for securely retaining workpieces of up to 80 mm thick, making it particularly useful when working with long and thin materials such as veneers. It comes in two separately controlled pieces. A 6 bar pneumatic connection is required.

**M64070** For 2250 mm, clamping length 1975 mm

**M64071** For 3000 mm, clamping length 2725 mm

**M64072** For 3200 mm, clamping length 2925 mm

**M64073** For 3400 mm, clamping length 3125 mm

**M64074** For 3800 mm, clamping length 3525 mm

## CROSSCUT FENCES WITH FIXED 90° ANGLE: EVERYDAY ACCURACY.

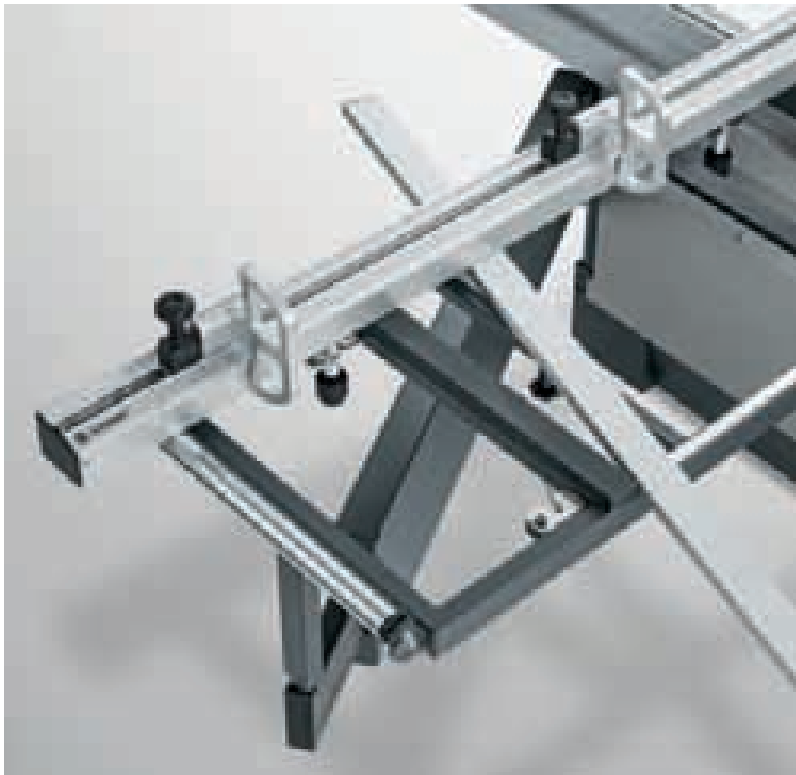

**Crosscut fence with fixed 90° angle.** The crosscut fence with fixed 90° angle earns its name every day helping out with precision cuts on workpieces of different lengths and formats. The stop can be slid into place easily without lifting. Two flip stops are included.

**M44400** Stops to 2500 mm  
(only in combination with sliding table to max. 3800 mm)

**M44402** Stops to 3200 mm **basic specification**



**DIGIT L.** For 1/10 mm accuracy when setting the length dimension. The display shows all stop settings applied. The central measuring and display unit calibrates the entire system in one operation. Two flip stops with fine adjustment, two batteries and a charger are included.

**M44401** Stops to 2500 mm

**M44403** Stops to 3200 mm

**Additional cross slide with floor support roller.** This accessory is well worth considering if you plan to be sizing large and heavy workpieces of up to 250 kg. Recommended floor rail: flat steel, 10x60 mm (length = 2x table length + 500 mm). The floor rail is to be provided by the customer.

**M64056**



**Pull-out cross slide extension.** This option makes it easier to cut longer/wider workpieces and increases the width of the support area for the manual crosscut fence.

**M64085**

## CROSSCUT-MITRE FENCES: PRECISION, PLAIN AND SIMPLE.

**Crosscut mitre fence.** This patented Altendorf fence, with integral length compensation, makes it easier to perform bevel cuts and mitre cuts precisely in one function. The set angle can be adjusted continuously over a range of 49° with a graduated scale and the robust, free-sliding zero-play flip stops can be positioned individually at any distance up to a maximum of 3 500 mm. The outer stop docks into the roller-stabilised telescopic extension for distances longer than about 1 700 mm. The integral length compensation feature enables the fence to be moved precisely to any required position when cutting mitres with no need of additional length compensation aids: simply slide the fence rule to the desired angle using the scale and then set the flip stop to the length required.

**M44404** Stops to 3 500 mm



**DIGIT L.** For 1/10 mm accuracy when setting the length dimension. The display shows all stop settings applied. The central measuring and display unit calibrates the entire system in one operation. Two flip stops with fine adjustment, a charger and two high-performance batteries are included.

**M44406** Stops to 3 200 mm

**DIGIT LD.** For 1/10 mm accuracy when setting the length dimension. The display shows all stop settings applied. The central measuring and display unit calibrates the entire system in one operation and displays angles in digital format, enabling a level of precision of  $\pm 1/100^\circ$ . The length dimension is calculated automatically as a function of the mitre angle. Two flip stops with fine adjustment, a charger and two high-performance batteries are included.

**M44408** Stops to 3 200 mm



**Pull-out cross slide extension.** This option makes it easier to saw longer/wider workpieces and increases the width of the crosscut-mitre fence. It extends to a distance of 650 mm.

**M64085**

## THE PARALLELOGRAM CROSS SLIDE: STRAIGHTFORWARD IN USE.



**Parallelogram cross slide (PQS).** Accurate and wear-free, this system features a robust 90° locking mechanism that ensures the right-angle position is absolutely reproducible. The fence can be angled by up to 47° in either direction. The integrated digital display shows the set angle with an accuracy of 1/100° for optimal precision. Also included is length compensation, which is simply taken from a scale when the fence is angled. Two flip stops are included.

**M44409** Stops to 3 500 mm



**DIGIT L.** For 1/10 mm accuracy when setting the length dimension. The display shows all stop settings applied. The central measuring and display unit calibrates the entire system in one operation. Integral length compensation is included. Two flip stops with fine adjustment and two high-performance batteries with charger are included.

**M44411** Stops to 3 200 mm

**DIGIT LD.** For 1/10 mm accuracy when setting the length dimension. The display shows all stop settings applied. The central measuring and display unit calibrates the entire system in one operation and angles are displayed in digital format, enabling a level of precision of  $\pm 1/100^\circ$ . The length dimension is calculated automatically as a function of the mitre angle. Two flip stops with fine adjustment, a charger and two high-performance batteries are included.

**M44412** Stops to 3 200 mm



**Cross slide extension.** The fixed cross slide extension (up to 650 mm) with two separate supports makes it easier to saw wider/longer workpieces.

**M64086**



## CNC CROSSCUT FENCES: MOTORISED FOR CONVENIENCE.



**UNO 90 CNC crosscut fence.** Fixed in the 90° position, the UNO 90 CNC crosscut fence enables efficient and precise execution of right-angled cuts. The flip stop has a maximum travel of 1900 mm as standard, but the extension supplied can be fitted manually to give a longer fence with a maximum dimension of 2900 mm if required.

**M44413** Stops to 2900 mm

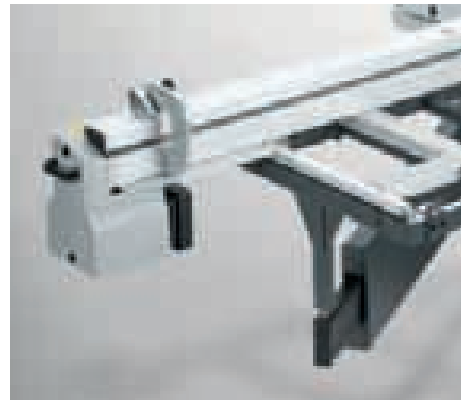

**DUO 90 CNC crosscut fence.** This fence features two CNC flip stops with a maximum travel of 3500 mm. It is fixed in the 90° position. Workpieces can be positioned against either side of the fence. The DUO 90 CNC crosscut fence is not compatible with the F45 ProDrive control unit.

**M44414** Stops to 3500 mm



**DUO FLEX CNC crosscut-mitre fence.** The DUO Flex fence can be angled manually by up to 47° for easy and convenient bevel and mitre cuts. It includes automatic length compensation and two motorised flip stops (travel to 3500 mm). It is not necessary to lift the fence to switch between the front and rear positions on the cross slide. The flip stops can be used on both sides. This means you can make mitre cuts to the inside or outside dimension and cut compound mitres in a single operation. The DUO Flex CNC crosscut-mitre fence is not compatible with the F45 ProDrive control unit.

**M44415** Stops to 3500 mm

**Cross slide extension.** The cross slide extension makes it easier to saw wider/longer workpieces. Total extension to 650 mm.

**M64085** UNO 90 (pull-out)

**M64087** DUO 90 (fixed)

**M64088** DUO Flex (pull-out)

## THE ALTENDORF RIP FENCES: PRECISION WITHOUT EQUAL.



**Rip fence with manual fine adjustment.** Setting the fence is easy; the precision fine adjustment makes for great accuracy. The hard chrome-plated round bar system ensures the fence moves smoothly. The rip fence drops down clear of the machine table level to free up extra space for dividing large panels.

- M44420** Cutting width 800 mm
- M44421** Cutting width 1000 mm
- M44422** Cutting width 1300 mm
- M44423** Cutting width 1600 mm

**basic specification**

**Rip fence with DIGIT X.** Digital cutting width display for the rip fence with manual fine adjustment. This electronic measuring system ensures rapid and precise adjustment of the rip fence. Recurring dimensions can be reproduced exactly and checked on the DIGIT X display. The correction for the rip fence position is shown digitally on the machine control unit's display when working with the saw blade tilted. The system is not subject to wear and is unaffected by dust. Dimensions are corrected automatically when the fence is switched between the upright and the flat position.

- M44430** Cutting width 800 mm
- M44431** Cutting width 1000 mm
- M44433** Cutting width 1300 mm
- M44434** Cutting width 1600 mm





**CNC rip fence.** The CNC rip fence has a traverse speed of 250 mm/s and an accuracy of  $\pm 1/10$  mm. The high-precision five-point recirculating ball spindle system needs little maintenance and, along with the motor, is well protected by its integration into the aluminium profile. The fence detects its position automatically, especially in the danger area around the saw blade, and has an emergency cut-out to prevent the risk of crushing. Dimensions are corrected automatically when the fence is switched between the upright and the flat position or when working with the saw blade tilted.

**M44440** Cutting width 800 mm

**M44441** Cutting width 1000 mm

**M44443** Cutting width 1300 mm

**M44444** Cutting width 1600 mm

## EVEN MORE WAYS TO SIMPLIFY YOUR WORK.



**Toolbox.** The practical toolbox is a closable container capable of holding up to six tool carriers (maximum saw blade diameter 550mm) ready for use. Four tool carriers are included in the standard scope of supply. This option requires a minimum sliding table length of 3 000mm

**M44453**

**STEG.** The STEG second support makes sizing large panels easier.

**M44452**



**Clipboard.** The clipboard mounted at eye level directly on the control unit is convenience itself. Parts lists are secured with a clamp, enabling you to keep a close eye on your jobs or other working documents as you cut.

**M62003**



**Front support roller.** The 300mm-wide front support roller is particularly useful when cutting longer workpieces on the rip fence. It can be folded down through 90° in one movement to stow under the sliding table (minimum length 3 000mm) when not required.

**M44450**



## DOUBLE-SIDED MITRE FENCES: TWICE AS USEFUL.



**DUPLEX D.** The DUPLEX D provides the same functionality as the DUPLEX plus a digital angle display that shows values to an accuracy of  $1/100^\circ$ . Digital angle display and analogue length scale for adjustment, integral length compensation.

**M64062** Stops to 1 350 mm

**M64063** Stops to 2 150 mm



**DUPLEX double-sided mitre fence.** DUPLEX fences make it possible to realise bevel cuts at any angle between  $0$  and  $90^\circ$  with speed and precision. Set the DUPLEX to  $45^\circ$  and a mitre cut can be made on both sides of the workpiece without resetting the two fences. Dimensions are set using a magnifier, a measuring scale and a length compensation scale. All DUPLEX fences can be positioned anywhere along the entire length of the sliding table.

**M64060** Stops to 1 350 mm

**M64061** Stops to 2 150 mm



**DUPLEX DD.** An exclusive Altendorf development, the DUPLEX DD has been patented worldwide. Its greatest benefits are that it not only eliminates tedious calculations and measurement checking completely, but even removes the need for test cuts. The high precision DUPLEX DD electronics incorporate automatic length compensation and calculate the distance to the stops as a function of the angle on both sides of the fence and display both figures digitally. Digital angle display and digital length display for adjustment, automatic length compensation. Batteries included.

**M64064** Stops to 1 350 mm

**M64065** Stops to 2 150 mm

## RETAIN WORKPIECES SECURELY FOR SAFER WORKING.



**Manual quick-action clamp.** The alternative to the pneumatic clamp. The manual quick-action clamp can be positioned on the sliding table easily and is equally easy to fix in place, ensuring the workpiece is reliably retained on the table and against the crosscut fence. It has a clamping height of up to 200 mm and provides extra safety at very little extra cost.

M64090



**Pneumatic quick-action clamp.** Secures the workpiece in place on the sliding table. Activated by radio remote control, the quick-action clamp exerts a clamping force of up to 1000 N. The workpiece is held rock solid against the crosscut fence. It can clamp workpieces up to 170 mm thick. Available with one or two clamping units. Pneumatic connection to be provided by customer (6 bar).

- M64091 With one clamping unit (clamping range 0–90 mm)
- M64092 With two clamping units (clamping range 0–90 mm)
- M64093 With one clamping unit (clamping range 80–170 mm)
- M64094 With two clamping units (clamping range 80–170 mm)
- M64184 With one clamping unit (clamping range 120–210 mm)
- M64185 With two clamping units (clamping range 120–210 mm)

**Laser cutting line marker.** The laser cutting line marker shows the cutting line clearly for all cut lengths, which is useful when trimming or cutting marked jobs such as steps. Use it to save both time and materials.

M64066

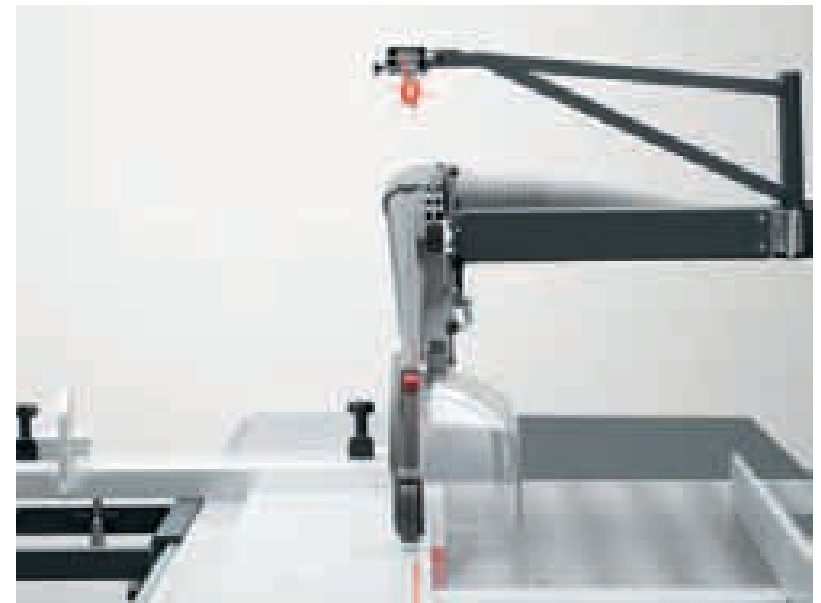



**PALIN.** Used in combination with the crosscut fence, the PALIN makes it possible to complete parallel and conical cuts in long, narrow workpieces with absolute accuracy. The measuring system butts against the side of the workpiece rather than the end, so no cutting length is lost. The operator is able to make quick and absolutely parallel cuts in parts of different lengths, even without moving the PALIN. In addition, the PALIN can be used as a workpiece support if the measuring system is removed. Also available is the PALIN D model, which offers digital measurement display and fine adjustment. Adjustment range 80–950 mm.

**M64058** PALIN, Graduated scale for adjustment

**M64059** PALIN D, Digital measurement display with fine adjustment, batteries included

Perfect cutting results with aluminium and plastics too: You can process a wide range of different materials with the F 45. Thousands of Altendorf sliding table saws in use at companies around the world give proof of that every day.



**Coolant spray device.** Use of a coolant spray device is recommended when working with plastics with a low melting point and for certain light metal alloys. Your Altendorf will cut nonferrous metals and plastics cleanly, with sharp contours, to within a tenth of a millimetre.

**M64067**

# TECHNICAL SPECIFICATIONS.

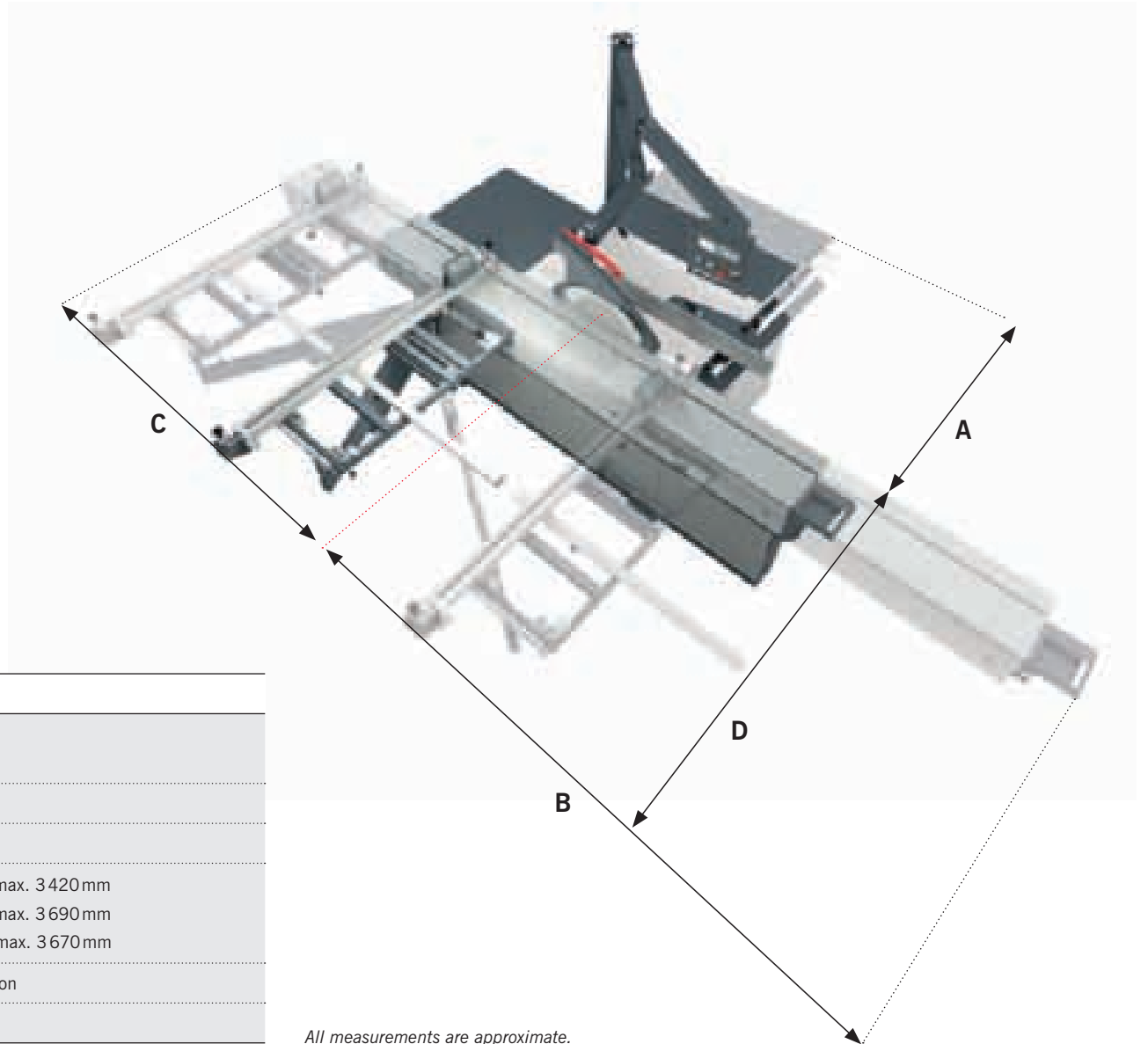

## IN SIMPLE TERMS, YOUR F45 NEEDS:

<b>A</b>	Manual adjustment: Cutting width + 280 mm Motorised adjustment: Cutting width + 360 mm
<b>B</b>	Table length + 360 mm
<b>C</b>	Table length + 290 mm
<b>D</b>	Crosscut fence: 1890 – max. 3420 mm Crosscut-mitre fence and Parallelogram cross slide: 1960 – max. 3690 mm CNC crosscut fence UNO/DUO: 2200 – max. 3670 mm
	Machine weight starting at 1170 kg, depending on configuration
	Table height 910 mm

*All measurements are approximate.*



**SLIDING TABLE CUTTING LENGTHS** Maximum cutting lengths when using clamping shoe or crosscut fence. Not valid for crosscut fence, stops to 2500mm.

Table length (mm)	2250	3000	3200	3400	3800	4300	5000
Cutting length (mm) with Crosscut fence, Crosscut-mitre fence, Parallelogram cross slide and UNO	2155	2905	3105	3305	3705	4205	4205
Cutting length (mm) DUO and DUO Flex	2100	2850	3050	3250	3650	4155	4155

**TIP-SERVO-DRIVE**

Cutting length (mm) without scoring saw blade	1840	2590	2790	2990	3390	3870	3870
Cutting length (mm) with scoring saw blade	1725	2475	2675	2875	3275	3775	3775

**MAXIMUM SAW BLADE PROTRUSION** <sup>1)</sup>Scorer blade must be removed. <sup>2)</sup>Not in combination with scorer unit.

	One-way tilt			Two-way tilt		
Saw blade diameter (mm)	450 <sup>1</sup>	500 <sup>1</sup>	550 <sup>2</sup>	450 <sup>1</sup>	500 <sup>1</sup>	550 <sup>1</sup>
Saw blade protrusion 90°	154	179	204	154	179	204
Saw blade protrusion +45°	105	123	141	98	115	132
Saw blade protrusion -45°	—	—	—	69	86	103

**ELECTRICAL POWER REQUIREMENTS**

	One-way tilt				Two-way tilt with VARIO			
Motor (kW)	4	5,5	7,5	11	VARIO	5	6,5	
Voltage (V)	380-420	380-420	380-420	380-400	380-400	380-400	380-400	
Frequency (Hz)	50	50	50	50	50	50	50	
Current (A) with/without scorer	8/10	11.5/13.5	15.5/17.5	22.5/24.5	11/13	11/13	15/17	
Fuses/circuit breakers	20	25	25	35	35	35	35	

**DUST EXTRACTION CONNECTIONS**

Top connection	Ø = 80 mm
Bottom connection	Ø = 120 mm
Pressure drop	1200 Pa with a total connection diameter, Ø = 140 mm
Minimum air requirement	V <sub>min</sub> = 1110 m <sup>3</sup> /h at 20 m/sec

The cross section of the mains cable depends on the machine's distance from the power source and must be determined by a qualified electrician (Power drop in the input cable < 3%). For VARIO machines: RCD protection type B, all current (AC/DC) sensitive. Minimum cross section of the mains cable with VARIO is 4x4 mm<sup>2</sup>. Please contact your Altendorf sales partner if your power supply does not match the requirements shown. Workstation noise level 84.1 dB (A).

## RELIABLY AT YOUR SIDE WITH EXPERTISE AND A PERSONAL TOUCH:

### THE ALTENDORF SERVICE TEAM.

Our team of Altendorf service engineers, customer advisors and sales staff provides a rapid and uncomplicated response to every customer enquiry. Typically over 90% of enquiries are resolved successfully at the first attempt. We can help you even faster over the telephone if you register your saw with us in advance. Our experienced field service team and numerous trained specialist dealers ensure continuous customer care worldwide.

**The Altendorf Service Hotline: +49 571 9550-222**



## ALTENDORF INSPECT: THE HEALTH CHECK FOR YOUR SLIDING TABLE SAW.

### ALTENDORF INSPECT.

Altendorf saws are built to run and run. Even the best saw needs a little care now and again though, which is why we created Altendorf Inspect: the health check for your Altendorf sliding table saw. An Altendorf service engineer will give your saw a thorough examination, establishing whether any of the parts subject to wear need to be replaced, reviewing the basic settings of your saw and checking all machine functions, all for an eminently affordable fixed price. Our only additional charge will be for any replacement parts required.



## ALTENDORF ONLINE: EQUALLY GOOD WITH PC, TABLET OR SMART PHONE.

*YOUR CONSTANT LINK TO YOUR F45.*

The Altendorf website works equally well on PC, tablet or smart phone: Images and text are automatically adapted to suit your device. Discover your F45 – no matter where you are. And of course all other Altendorf machines and offers as well: training, guarantees, maintenance and other services. Keep in touch!



## BRINGING FRIENDS OF THE COMPANY TOGETHER:

*WELCOME TO THE ALTENDORF FORUM!*

The Altendorf Forum is the way to keep in touch with your friends at Altendorf. Be the first to find out about new developments and take advantage of the chance to communicate directly on technical matters with Altendorf staff and other industry experts. Meet specialists in different settings and for different purposes: a trade fair, a conference or a specific occasion such as a new product presentation, a new service or a special campaign. Your membership card ensures that you will always be involved whenever Altendorf has something particularly important to share.

**Join the Altendorf Forum. Register now at [www.altendorf.com](http://www.altendorf.com)**



